

Switchmode Dual High Efficiency Power Rectifiers

... Designed for use in switching power supplies, inverters and as free wheeling diodes. These state-of-the-art devices have the following features:

- * High Surge Capacity
- * Low Power Loss, High efficiency
- * Glass Passivated chip junctions
- * 150 °C Operating Junction Temperature
- * Low Stored Charge Majority Carrier Conduction
- * Low Forward Voltage , High Current Capability
- * High-Switching Speed 75 & 100 Nanosecond Recovery Time
- * Plastic Material used Carries Underwriters Laboratory

**HIGH EFFICIENCY
RECTIFIERS**

**16 AMPERES
300 -- 600 VOLTS**

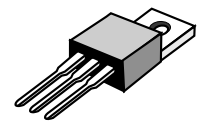

TO-220AB

MAXIMUM RATINGS

Characteristic	Symbol	H16C				Unit
		30	40	50	60	
Peak Repetitive Reverse Voltage Working Peak Reverse Voltage DC Blocking Voltage	V_{RRM} V_{RWM} V_R	300	400	500	600	V
RMS Reverse Voltage	$V_{R(RMS)}$	210	280	350	420	V
Average Rectifier Forward Current Per Leg Per Total Device	$I_{F(AV)}$	8.0 16				A
Peak Repetitive Forward Current (Rate V_R , Square Wave, 20kHz, $T_c=125^\circ C$)	I_{FM}	16				A
Non-Repetitive Peak Surge Current (Surge applied at rate load conditions halfwave, single phase, 60Hz)	I_{FSM}	125				A
Operating and Storage Junction Temperature Range	T_J, T_{stg}	- 65 to + 150				°C

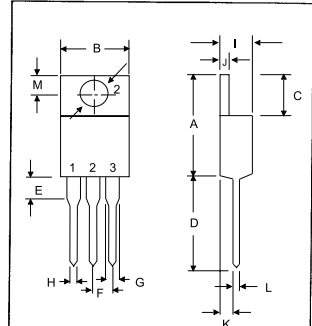

DIM	MILLIMETERS	
	MIN	MAX
A	14.68	15.32
B	9.78	10.42
C	6.01	6.52
D	13.06	14.62
E	3.57	4.07
F	2.42	2.66
G	1.12	1.36
H	0.72	0.96
I	4.22	4.98
J	1.14	1.36
K	2.20	2.97
L	0.33	0.55
M	2.48	2.98
O	3.70	3.90

ELECTRICAL CHARACTERISTICS

Characteristic	Symbol	H16C				Unit
		30	40	50	60	
Maximum Instantaneous Forward Voltage ($I_F=8.0$ Amp, $T_c = 25^\circ C$) ($I_F=8.0$ Amp, $T_c = 100^\circ C$)	V_F	1.30 1.12		1.50 1.34		V
Maximum Instantaneous Reverse Current (Rated DC Voltage, $T_c = 25^\circ C$) (Rated DC Voltage, $T_c = 125^\circ C$)	I_R	10 500				uA
Reverse Recovery Time ($I_F = 0.5$ A, $I_R = 1.0$, $I_{rr} = 0.25$ A)	T_{rr}	75 100				ns
Typical Junction Capacitance (Reverse Voltage of 4 volts & f=1 MHz)	C_P	70				pF

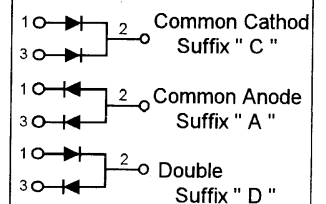

H16C30 Thru H16C60

FIG-1 TYPICAL FORWARD CHARACTERISTICS

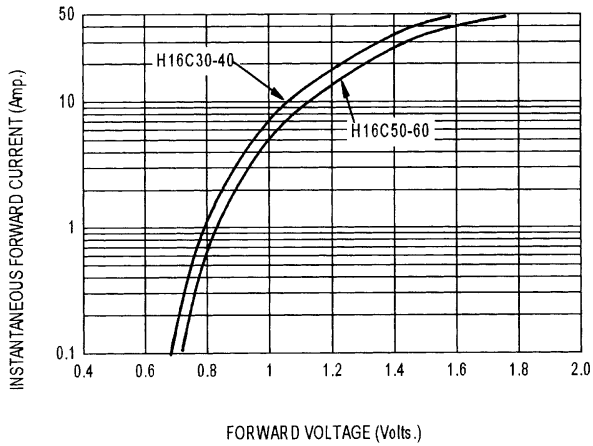

FIG-3 FORWARD CURRENT DERATING CURVE

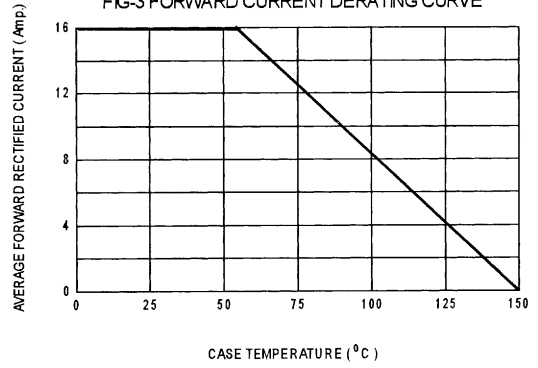

FIG-2 TYPICAL REVERSE CHARACTERISTICS

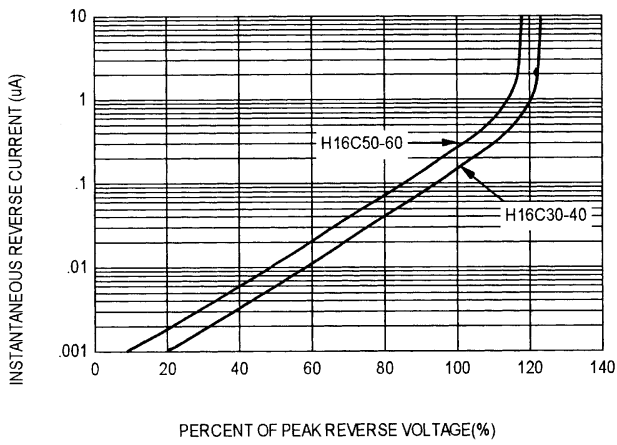

FIG-4 TYPICAL JUNCTION CAPACITANCE

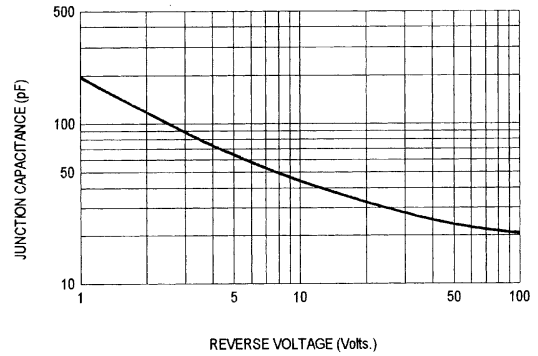
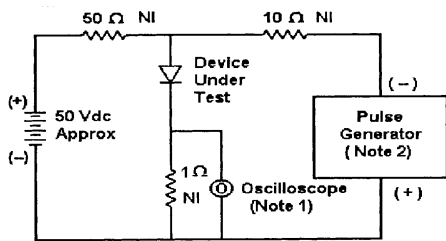
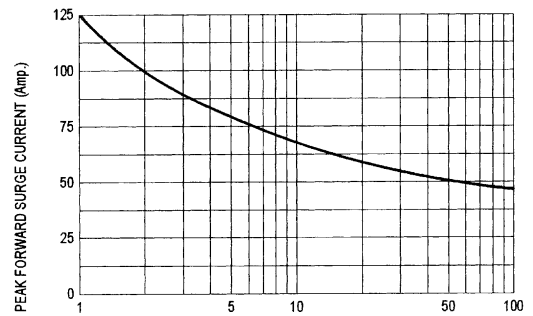
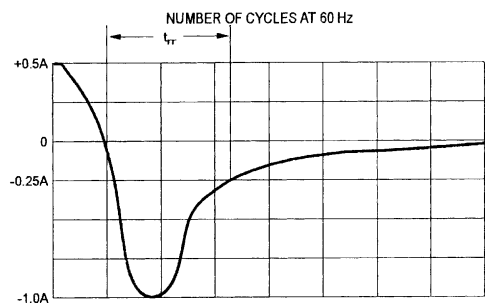

FIG-5 PEAK FORWARD SURGE CURRENT



Notes:
 1. Rise Time = 7 ns max. Input Impedance = 1 M Ω , 22 pF
 2. Rise Time = 10 ns max. Input Impedance = 50 Ω



Set time base for 20/50 ns/div

Fig-6 Reverse Recovery Time Characteristic and Test Circuit Diagram