

# Clock Driver Quad D-Type Flip-Flop With Matched Propagation Delays

The MC74F1803 is a high-speed, low-power, quad D-type flip-flop featuring separate D-type inputs and inverting outputs with closely matched propagation delays. With a buffered clock (CP) input that is common to all flip-flops, the MC74F1803 is useful in high-frequency systems as a clock driver, providing multiple outputs that are synchronous. Because of the matched propagation delays, the duty cycles of the output waveforms in a clock driver application are symmetrical within 2.0 nanoseconds.

- Edge-Triggered D-Type Inputs
- Buffered Positive Edge-Triggered Clock
- Matched Outputs for Synchronous Clock Driver Applications
- Outputs Guaranteed for Simultaneous Switching

Pinout: 14-Lead Plastic (Top View)

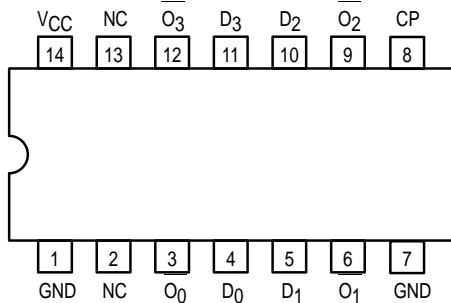

LOGIC DIAGRAM

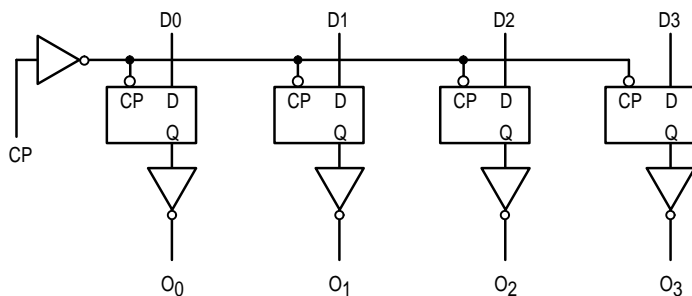

VCC = Pin 14; GND = Pins 1,7; NC = Pins 2, 13

NOTE: This diagram is provided only for the understanding of logic operations and should not be used to estimate propagation delays

## MC74F1803

### CLOCK DRIVER QUAD D-TYPE FLIP-FLOP WITH MATCHED PROPAGATION DELAYS

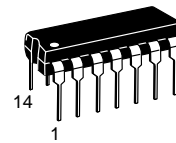

**N SUFFIX**  
PLASTIC  
CASE 646-06

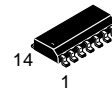

**D SUFFIX**  
SOIC  
CASE 751A-03

LOGIC SYMBOL

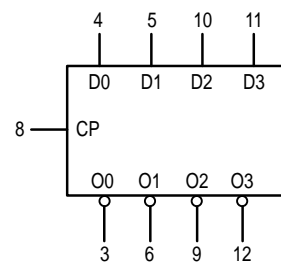

VCC = PIN 14  
GND = PINS 1 AND 7  
NC = PINS 2 AND 13



# MC74F1803

## FUNCTIONAL DESCRIPTION

The MC74F1803 consists of four positive edge-triggered flip-flops with individual D-type inputs and inverting outputs. The buffered clock is common to all flip-flops and the following specifications allow for outputs switching simultaneously. The four flip-flops store the state of their individual D inputs that meet the setup and hold time requirements on the LOW-to-HIGH Clock (CP) transition. The maximum frequency of the clock input is 70 megahertz and the LOW-to-HIGH and HIGH-to-LOW

propagation delays of the  $\overline{O_n}$  output vary by at most, 2.0 nanoseconds. Therefore, the device is ideal for use as a divide-by-two driver for high-frequency clock signals that require symmetrical duty cycles. In addition, the output-to-output skew is a maximum of 2.0 nanoseconds. Finally, the  $I_{OH}$  specification at 2.5 volts is guaranteed to be at least -20 milli-amps. If their inputs are identical, multiple outputs can be tied together and the  $I_{OH}$  is commensurately increased.

## GUARANTEED OPERATION RANGES

Symbol	Parameter	Min	Typ	Max	Unit
$V_{CC}$	Supply Voltage	4.5	5.0	5.5	V
$T_A$	Operating Ambient Temperature Range	0	25	70	°C
$I_{OH}$	Output Current — High	—	—	-20	mA
$I_{OL}$	Output Current — Low	—	—	24	mA

## DC CHARACTERISTICS OVER OPERATING TEMPERATURE RANGE (Unless otherwise specified)

Symbol	Parameter	Limits			Unit	Test Conditions 1,2
		Min	Typ	Max		
$V_{IH}$	Input HIGH Voltage	2.0	—	—	V	Guaranteed Input HIGH Voltage
$V_{IL}$	Input LOW Voltage	—	—	0.8	V	Guaranteed Input LOW Voltage
$V_{IK}$	Input Clamp Diode Voltage	—	—	-1.2	V	$V_{CC} = \text{MIN}$ , $I_{IN} = -18 \text{ mA}$
$V_{OH}$	Output HIGH Voltage $A_n$ Outputs	74	2.5	—	V	$I_{OH} = -20 \text{ mA}$ , $V_{CC} = 4.5 \text{ V}$
$V_{OL}$	Output LOW Voltage $A_n$ Outputs	74	—	0.35	V	$I_{OL} = 24 \text{ mA}$ , $V_{CC} = \text{MIN}$
$I_{IH}$	Input HIGH Current	—	—	20	$\mu\text{A}$	$V_{CC} = \text{MAX}$ , $V_{IN} = 2.7 \text{ V}$
		—	—	100	$\mu\text{A}$	$V_{CC} = \text{MAX}$ , $V_{IN} = 7.0 \text{ V}$
$I_{IL}$	Input LOW Current	—	—	-0.6	mA	$V_{CC} = \text{MAX}$ , $V_{IN} = 0.5 \text{ V}$
$I_{OS}$	Output Short Circuit Current <sup>3</sup>	-60	—	-150	mA	$V_{CC} = \text{MAX}$ , $V_{OUT} = 0 \text{ V}$
$I_{CC}$	Power Supply Current	—	—	70	mA	$V_{CC} = \text{MAX}$

- For conditions shown as MIN or MAX, use the appropriate value specified under recommended operating conditions for the applicable device type.
- Normal test conditions for this device are all four outputs switching simultaneously. Two outputs of the MC74F1803 can be tied together and the  $I_{OH}$  doubles.
- Not more than one output should be shorted at a time, nor for more than 1 second.

## AC OPERATING REQUIREMENTS ( $T_A = 0^\circ\text{C}$ to $+70^\circ\text{C}$ ; $V_{CC} = +5.0 \text{ V} \pm 10\%$ ; $R_L = 500 \Omega$ )

Symbol	Parameter	$C_L = 50 \text{ pF}$		Unit
		Min	Max	
$t_S(H)$ $t_S(L)$	Setup Time, HIGH or LOW: $D_n$ to CP	3.0	—	ns
$t_f$	$t_p + t_s$ <sup>1</sup>	—	9.0	ns
$t_H(H)$ $t_H(L)$	Hold Time, HIGH or LOW: $D_n$ to CP	2.0	—	ns
$t_W(H)$ $t_W(L)$	Cp Pulse Width HIGH or LOW	7.0	—	ns
		6.0	—	

- The combination of the setup time ( $t_S$ ) requirement and maximum propagation delay ( $t_p$ ) are guaranteed to be within this limit for all conditions.

**AC ELECTRICAL CHARACTERISTICS** ( $T_A = 0^\circ\text{C}$  to  $+70^\circ\text{C}$ :  $V_{CC} = +5.0\text{ V} \pm 10\%$ :  $R_L = 500\ \Omega$ ) <sup>1</sup>

Symbol	Parameter	$C_L = 50\text{ pF}$		Unit
		Min	Max	
$f_{\text{max}}$	Maximum Clock Frequency	70	–	MHz
$t_{\text{PLH}}$ $t_{\text{PHL}}$	Propagation Delay CP to $O_n$	3.0	7.5	ns
$t_{\text{Pv}}$	Propagation Delay CP to $O_n$ Variation	–	3.0	ns
$t_{\text{ps } O_0, O_1, O_2, O_3}$	Propagation Delay Skew $ t_{\text{PLH Actual}} - t_{\text{PHL Actual}} $ for $O_0, O_1, O_2, O_3$	–	2.0	ns
$t_{\text{os}}$	Output to Output Skew <sup>2</sup> $ t_{\text{p } O_n} - t_{\text{p } O_m} $	–	2.0	ns
$t_{\text{rise}}, t_{\text{fall } O_1}$	Rise/Fall Time for $O_1$ (0.8 to 2.0 V)	–	3.0	ns
$t_{\text{rise}}, t_{\text{fall } O_0, O_2, O_3}$	Rise/Fall Time for $O_1, O_2, O_3$ (0.8 to 2.0 V)	–	3.5	ns

1. The test conditions used are all four outputs switching simultaneously. The AC characteristics described above are also guaranteed when two outputs are tied together.
2. Where  $t_{\text{p } O_n}$  and  $t_{\text{p } O_m}$  are the actual propagation delays (any combination of high or low) for two separate outputs from a given high transition of CP.
3. For a given set of conditions (i.e., capacitive load, temperature,  $V_{CC}$ , and number of outputs switching simultaneously) the variation from device to device is guaranteed to be less than or equal to the maximum.

**TYPICAL MC74F1803 APPLICATION**

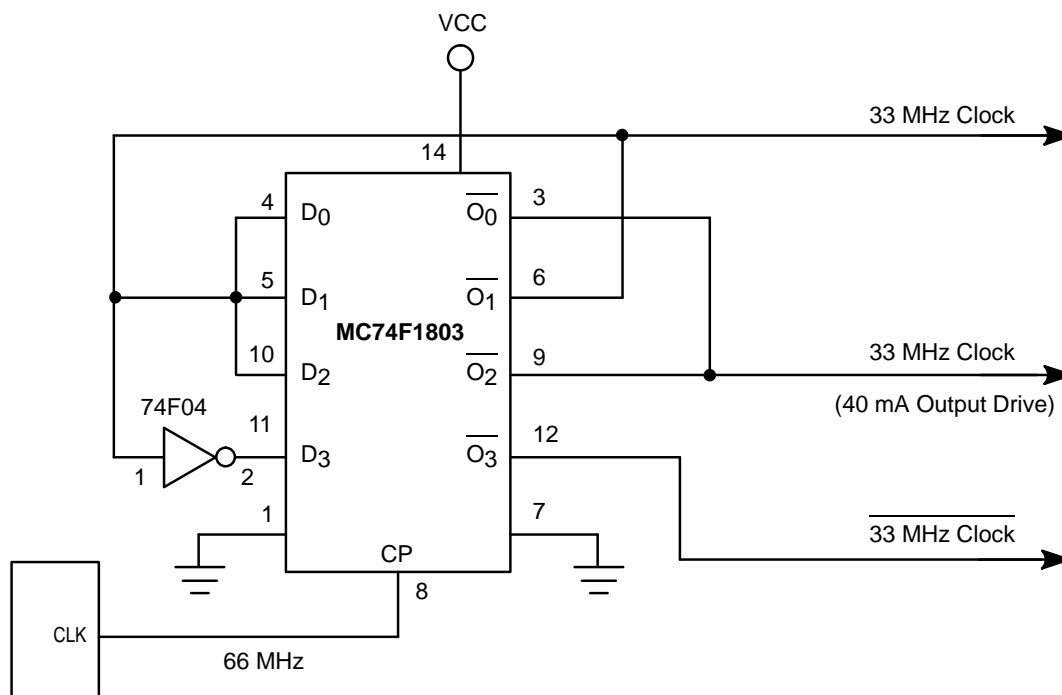

OUTLINE DIMENSIONS

**N SUFFIX**  
**PLASTIC PACKAGE**  
**CASE 646-06**

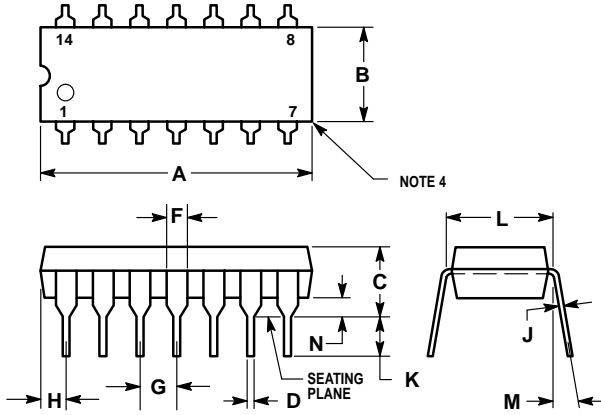

NOTES:

- LEADS WITHIN 0.13 mm (0.005) RADIUS OF TRUE POSITION AT SEATING PLANE AT MAXIMUM MATERIAL CONDITION.
- DIMENSION "L" TO CENTER OF LEADS WHEN FORMED PARALLEL.
- DIMENSION "B" DOES NOT INCLUDE MOLD FLASH.
- ROUNDED CORNERS OPTIONAL.
- 646-05 OBSOLETE, NEW STANDARD 646-06.

DIM	MILLIMETERS		INCHES	
	MIN	MAX	MIN	MAX
A	18.16	19.56	0.715	0.770
B	6.10	6.60	0.240	0.260
C	3.69	4.69	0.145	0.185
D	0.38	0.53	0.015	0.021
F	1.02	1.78	0.040	0.070
G	2.54 BSC		0.100 BSC	
H	1.32	2.41	0.052	0.095
J	0.20	0.38	0.008	0.015
K	2.92	3.43	0.115	0.135
L	0.62 BSC		0.300 BSC	
M	0.39	1.01	0.015	0.039
N				

**D SUFFIX**  
**SOIC PACKAGE**  
**CASE 751A-02**

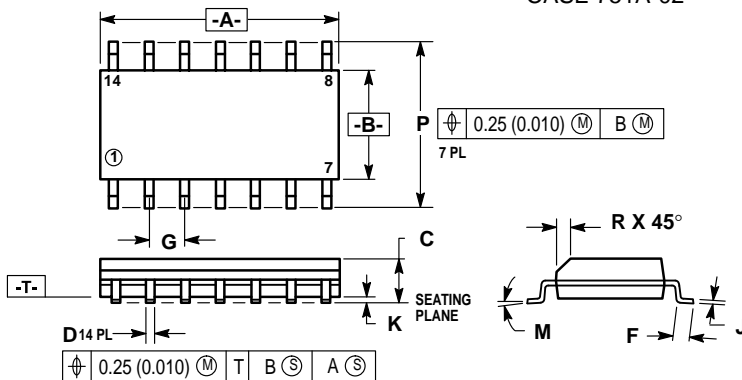

NOTES:

- DIMENSIONS "A" AND "B" ARE DATUMS AND "T" IS A DATUM SURFACE.
- DIMENSIONING AND TOLERANCING PER ANSI Y14.5M, 1982.
- CONTROLLING DIMENSION: MILLIMETER.
- DIMENSION A AND B DO NOT INCLUDE MOLD PROTRUSION.
- MAXIMUM MOLD PROTRUSION 0.15 (0.006) PER SIDE.
- 751A-01 IS OBSOLETE, NEW STANDARD 751A-02.

DIM	MILLIMETERS		INCHES	
	MIN	MAX	MIN	MAX
A	8.55	8.75	0.337	0.344
B	3.80	4.00	0.150	0.157
C	1.35	1.75	0.054	0.068
D	0.35	0.49	0.014	0.019
F	0.40	1.25	0.016	0.049
G	1.27 BSC		0.050 BSC	
J	0.19	0.25	0.008	0.009
K	0.10	0.25	0.004	0.009
M	0	7	0	7
P	5.80	6.20	0.229	0.244
R	0.25	0.50	0.010	0.019

Motorola reserves the right to make changes without further notice to any products herein. Motorola makes no warranty, representation or guarantee regarding the suitability of its products for any particular purpose, nor does Motorola assume any liability arising out of the application or use of any product or circuit, and specifically disclaims any and all liability, including without limitation consequential or incidental damages. "Typical" parameters can and do vary in different applications. All operating parameters, including "Typicals" must be validated for each customer application by customer's technical experts. Motorola does not convey any license under its patent rights nor the rights of others. Motorola products are not designed, intended, or authorized for use as components in systems intended for surgical implant into the body, or other applications intended to support or sustain life, or for any other application in which the failure of the Motorola product could create a situation where personal injury or death may occur. Should Buyer purchase or use Motorola products for any such unintended or unauthorized application, Buyer shall indemnify and hold Motorola and its officers, employees, subsidiaries, affiliates, and distributors harmless against all claims, costs, damages, and expenses, and reasonable attorney fees arising out of, directly or indirectly, any claim of personal injury or death associated with such unintended or unauthorized use, even if such claim alleges that Motorola was negligent regarding the design or manufacture of the part. Motorola and  are registered trademarks of Motorola, Inc. Motorola, Inc. is an Equal Opportunity/Affirmative Action Employer.

**How to reach us:**

**USA/EUROPE:** Motorola Literature Distribution;  
P.O. Box 20912; Phoenix, Arizona 85036. 1-800-441-2447

**JAPAN:** Nippon Motorola Ltd.; Tatsumi-SPD-JLDC, Toshikatsu Otsuki,  
6F Seibu-Butsuryu-Center, 3-14-2 Tatsumi Koto-Ku, Tokyo 135, Japan. 03-3521-8315

**MFAX:** RMFAX0@email.sps.mot.com -TOUCHTONE (602) 244-6609  
**INTERNET:** <http://Design-NET.com>

**HONG KONG:** Motorola Semiconductors H.K. Ltd.; 8B Tai Ping Industrial Park,  
51 Ting Kok Road, Tai Po, N.T., Hong Kong. 852-26629298

**MOTOROLA**

◇ CODELINE

MC74F1803/D

