

32K x 8 Bit Fast Static RAM

The MCM6206D is fabricated using Motorola's high-performance silicon-gate CMOS technology. Static design eliminates the need for external clocks or timing strobes, while CMOS circuitry reduces power consumption and provides for greater reliability.

This device meets JEDEC standards for functionality and pinout, and is available in plastic dual-in-line and plastic small-outline J-leaded packages.

- Single 5 V ± 10% Power Supply
- Fully Static — No Clock or Timing Strokes Necessary
- Fast Access Times: 12, 15, 20, and 25 ns
- Equal Address and Chip Enable Access Times
- Output Enable (\bar{G}) Feature for Increased System Flexibility and to Eliminate Bus Contention Problems
- Low Power Operation: 125 – 140 mA Maximum AC
- Fully TTL Compatible — Three State Output

BLOCK DIAGRAM

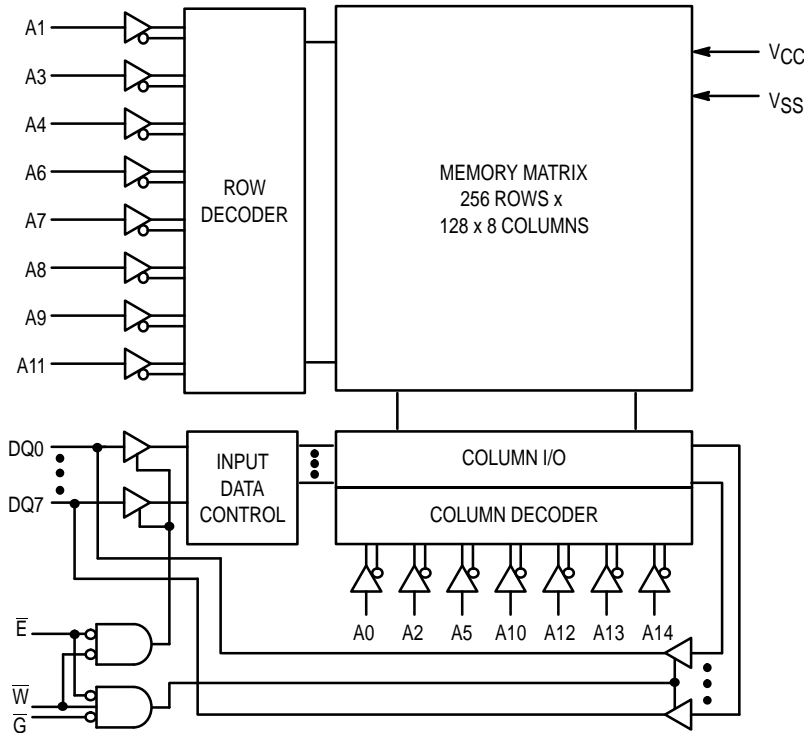

MCM6206D

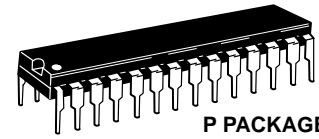

P PACKAGE
300 MIL PLASTIC
CASE 710B-01

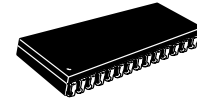

J PACKAGE
300 MIL SOJ
CASE 810B-03

PIN ASSIGNMENT

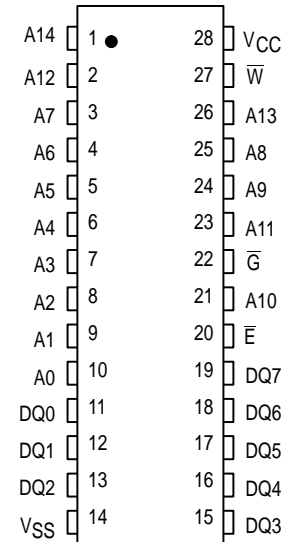

PIN NAMES

A0 – A14	Address Input
DQ0 – DQ7	Data Input/Data Output
\bar{W}	Write Enable
\bar{G}	Output Enable
\bar{E}	Chip Enable
VCC	Power Supply (+ 5 V)
VSS	Ground

TRUTH TABLE (X = Don't Care)

\bar{E}	\bar{G}	\bar{W}	Mode	V _{CC} Current	Output	Cycle
H	X	X	Not Selected	I _{SB1} , I _{SB2}	High-Z	–
L	H	H	Output Disabled	I _{CCA}	High-Z	–
L	L	H	Read	I _{CCA}	D _{out}	Read Cycle
L	X	L	Write	I _{CCA}	High-Z	Write Cycle

ABSOLUTE MAXIMUM RATINGS

Rating	Symbol	Value	Unit
Power Supply Voltage	V _{CC}	– 0.5 to + 7.0	V
Voltage Relative to V _{SS} For Any Pin Except V _{CC}	V _{in} , V _{out}	– 0.5 to V _{CC} + 0.5	V
Output Current	I _{out}	± 20	mA
Power Dissipation	P _D	1.0	W
Temperature Under Bias	T _{bias}	– 10 to + 85	°C
Operating Temperature	T _A	0 to + 70	°C
Storage Temperature—Plastic	T _{stg}	– 55 to + 125	°C

NOTE: Permanent device damage may occur if ABSOLUTE MAXIMUM RATINGS are exceeded. Functional operation should be restricted to RECOMMENDED OPERATING CONDITIONS. Exposure to higher than recommended voltages for extended periods of time could affect device reliability.

This device contains circuitry to protect the inputs against damage due to high static voltages or electric fields; however, it is advised that normal precautions be taken to avoid application of any voltage higher than maximum rated voltages to this high-impedance circuit.

This CMOS memory circuit has been designed to meet the dc and ac specifications shown in the tables, after thermal equilibrium has been established. The circuit is in a test socket or mounted on a printed circuit board and transverse air flow of at least 500 linear feet per minute is maintained.

DC OPERATING CONDITIONS AND CHARACTERISTICS

(V_{CC} = 5.0 V ±10%, T_A = 0 to 70°C, Unless Otherwise Noted)

RECOMMENDED OPERATING CONDITIONS

Parameter	Symbol	Min	Typ	Max	Unit
Supply Voltage (Operating Voltage Range)	V _{CC}	4.5	5.0	5.5	V
Input High Voltage	V _{IH}	2.2	—	V _{CC} + 0.3**	V
Input Low Voltage	V _{IL}	– 0.5*	—	0.8	V

* V_{IL} (min) = – 0.5 V dc; V_{IL} (min) = – 2.0 V ac (pulse width ≤ 20 ns)

** V_{IH} (max) = V_{CC} + 0.3 V dc; V_{IH} (max) = V_{CC} + 2.0 V ac (pulse width ≤ 20 ns)

DC CHARACTERISTICS

Parameter	Symbol	Min	Max	Unit
Input Leakage Current (All Inputs, V _{in} = 0 to V _{CC})	I _{lkg(I)}	—	± 1	μA
Output Leakage Current ($\bar{E} = V_{IH}$ or $\bar{G} = V_{IH}$, V _{out} = 0 to V _{CC})	I _{lkg(O)}	—	± 1	μA
Output High Voltage (I _{OH} = – 4.0 mA)	V _{OH}	2.4	—	V
Output Low Voltage (I _{OL} = 8.0 mA)	V _{OL}	—	0.4	V

POWER SUPPLY CURRENTS

Parameter	Symbol	– 12	– 15	– 20	– 25	Unit
AC Active Supply Current (I _{out} = 0 mA, V _{CC} = Max, f = f _{max})	I _{CCA}	140	135	130	125	mA
AC Standby Current ($\bar{E} = V_{IH}$, V _{CC} = Max, f = f _{max})	I _{SB1}	40	35	35	30	mA
CMOS Standby Current (V _{CC} = Max, f = 0 MHz, $\bar{E} \geq V_{CC} - 0.2$ V, V _{in} ≤ V _{SS} + 0.2 V, or ≥ V _{CC} – 0.2 V)	I _{SB2}	20	20	20	20	mA

CAPACITANCE (f = 1 MHz, dV = 3 V, T_A = 25°C, Periodically sampled rather than 100% tested)

Characteristic	Symbol	Max	Unit
Address Input Capacitance	C _{in}	6	pF
Control Pin Input Capacitance (\bar{E} , \bar{G} , \bar{W})	C _{in}	8	pF
I/O Capacitance	C _{I/O}	8	pF

AC OPERATING CONDITIONS AND CHARACTERISTICS

($V_{CC} = 5.0 \text{ V} \pm 10\%$, $T_A = 0 \text{ to } +70^\circ\text{C}$, Unless Otherwise Noted)

Input Timing Measurement Reference Level 1.5 V
 Input Pulse Levels 0 to 3.0 V
 Input Rise/Fall Time 5 ns

Output Timing Measurement Reference Level 1.5 V
 Output Load Figure 1A Unless Otherwise Noted

READ CYCLE (See Note 1)

Parameter	Symbol	- 12		- 15		- 20		- 25		Unit	Notes
		Min	Max	Min	Max	Min	Max	Min	Max		
Read Cycle Time	t_{AVAV}	12	—	15	—	20	—	25	—	ns	2
Address Access Time	t_{AVQV}	—	12	—	15	—	20	—	25	ns	
Enable Access Time	t_{ELQV}	—	12	—	15	—	20	—	25	ns	3
Output Enable Access Time	t_{GLQV}	—	6	—	8	—	10	—	12	ns	
Output Hold from Address Change	t_{AXQX}	4	—	4	—	4	—	4	—	ns	4,5,6
Enable Low to Output Active	t_{ELQX}	4	—	4	—	4	—	4	—	ns	4,5,6
Enable High to Output High-Z	t_{EHQZ}	0	7	0	8	0	9	0	10	ns	4,5,6
Output Enable Low to Output Active	t_{GLQX}	0	—	0	—	0	—	0	—	ns	4,5,6
Output Enable High to Output High-Z	t_{GHQZ}	0	6	0	7	0	8	0	10	ns	4,5,6
Power Up Time	t_{ELICCH}	0	—	0	—	0	—	0	—	ns	
Power Down Time	t_{EHICCL}	—	12	—	15	—	20	—	25	ns	

NOTES:

1. \bar{W} is high for read cycle.
2. All timings are referenced from the last valid address to the first transitioning address.
3. Addresses valid prior to or coincident with \bar{E} going low.
4. At any given voltage and temperature, t_{EHQZ} (max) is less than t_{ELQX} (min), and t_{GHQZ} (max) is less than t_{GLQX} (min), both for a given device and from device to device.
5. Transition is measured $\pm 500 \text{ mV}$ from steady-state voltage with load of Figure 1B.
6. This parameter is sampled and not 100% tested.
7. Device is continuously selected ($\bar{E} = V_{IL}$, $\bar{G} = V_{IL}$).

AC TEST LOADS

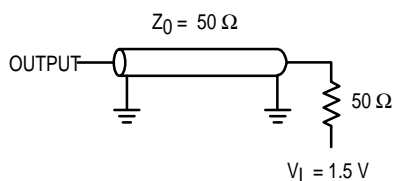

Figure 1A

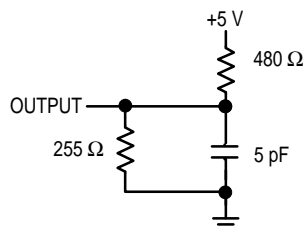

Figure 1B

TIMING LIMITS

The table of timing values shows either a minimum or a maximum limit for each parameter. Input requirements are specified from the external system point of view. Thus, address setup time is shown as a minimum since the system must supply at least that much time (even though most devices do not require it). On the other hand, responses from the memory are specified from the device point of view. Thus, the access time is shown as a maximum since the device never provides data later than that time.

WRITE CYCLE 1 (\overline{W} Controlled, See Notes 1 and 2)

Parameter	Symbol	- 12		- 15		- 20		- 25		Unit	Notes
		Min	Max	Min	Max	Min	Max	Min	Max		
Write Cycle Time	t_{AVAV}	12	—	15	—	20	—	25	—	ns	3
Address Setup Time	t_{AVWL}	0	—	0	—	0	—	0	—	ns	
Address Valid to End of Write	t_{AVWH}	10	—	12	—	15	—	20	—	ns	
Write Pulse Width	t_{WLWH} , t_{WLEH}	10	—	12	—	15	—	20	—	ns	
Write Pulse Width, \overline{G} High	t_{WLWH} , t_{WLEH}	10	—	10	—	12	—	15	—	ns	4
Data Valid to End of Write	t_{DVWH}	6	—	7	—	8	—	10	—	ns	
Data Hold Time	t_{WHDX}	0	—	0	—	0	—	0	—	ns	
Write Low to Output High-Z	t_{WLQZ}	0	6	0	7	0	8	0	10	ns	5,6,7
Write High to Output Active	t_{WHQX}	4	—	4	—	4	—	4	—	ns	5,6,7
Write Recovery Time	t_{WHAX}	0	—	0	—	0	—	0	—	ns	

NOTES:

1. A write occurs during the overlap of \overline{E} low and \overline{W} low.
2. If \overline{G} goes low coincident with or after \overline{W} goes low, the output will remain in a high impedance state.
3. All timings are referenced from the last valid address to the first transitioning address.
4. If $\overline{G} \geq V_{IH}$, the output will remain in a high impedance state.
5. At any given voltage and temperature, t_{WLQZ} (max) is less than t_{WHQX} (min), both for a given device and from device to device.
6. Transition is measured ± 500 mV from steady-state voltage with load of Figure 1B.
7. This parameter is sampled and not 100% tested.

WRITE CYCLE 1 (\overline{W} Controlled, See Notes 1 and 2)

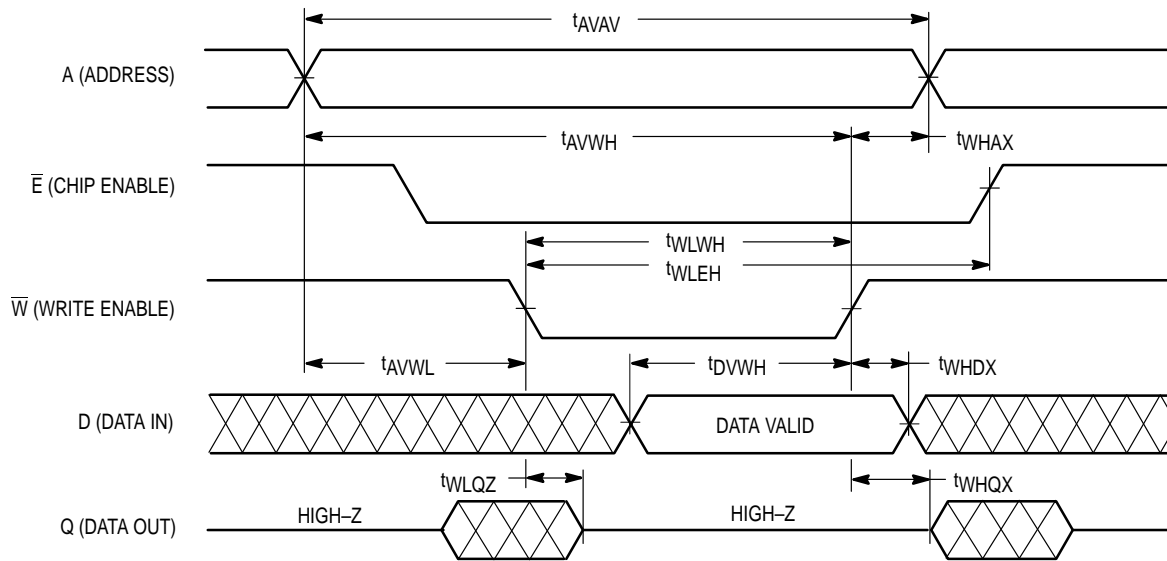

WRITE CYCLE 2 (\bar{E} Controlled, See Note 1)

Parameter	Symbol	- 12		- 15		- 20		- 25		Unit	Notes
		Min	Max	Min	Max	Min	Max	Min	Max		
Write Cycle Time	t_{AVAV}	12	—	15	—	20	—	25	—	ns	
Address Setup Time	t_{AVEL}	0	—	0	—	0	—	0	—	ns	
Address Valid to End of Write	t_{AVEH}	10	—	12	—	15	—	20	—	ns	
Enable to End of Write	t_{ELEH} , t_{ELWH}	9	—	10	—	12	—	15	—	ns	3,4
Data Valid to End of Write	t_{DVEH}	6	—	7	—	8	—	10	—	ns	
Data Hold Time	t_{EHDX}	0	—	0	—	0	—	0	—	ns	
Write Recovery Time	t_{EHAX}	0	—	0	—	0	—	0	—	ns	

NOTES:

1. A write occurs during the overlap of \bar{E} low and \bar{W} low.
2. All timings are referenced from the last valid address to the first transitioning address.
3. If \bar{E} goes low coincident with or after \bar{W} goes low, the output will remain in a high impedance state.
4. If \bar{E} goes high coincident with or before \bar{W} goes high, the output will remain in a high impedance state.

WRITE CYCLE 2 (\bar{E} Controlled, See Note 1)

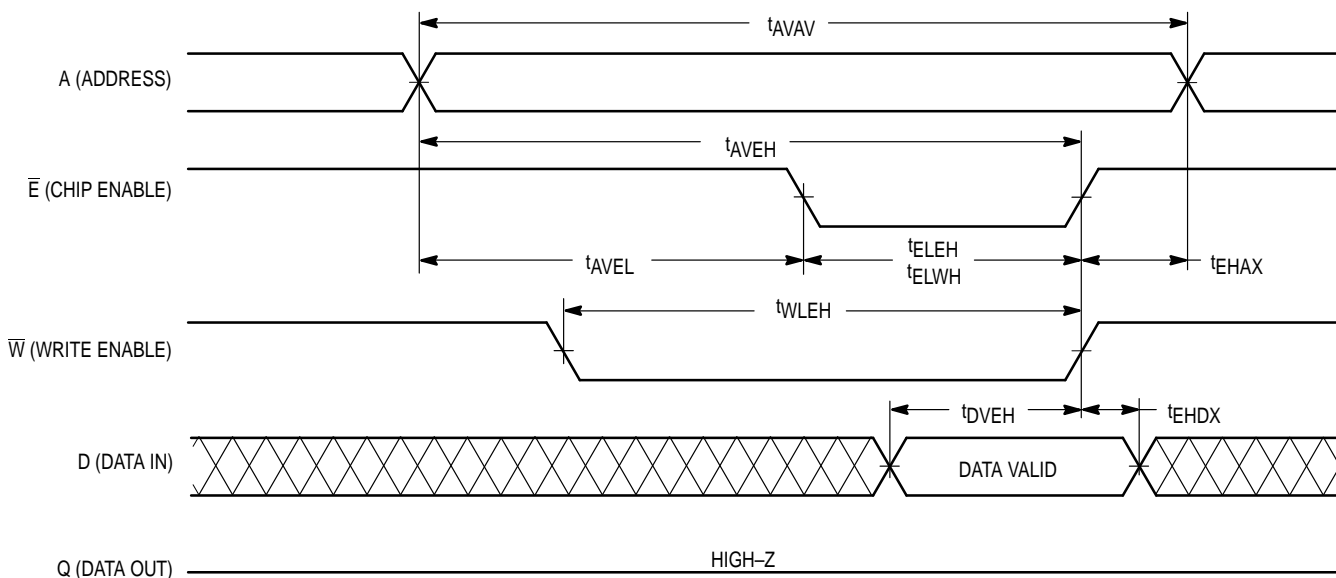

ORDERING INFORMATION
(Order by Full Part Number)



PACKAGE DIMENSIONS

CASE 710B-01 300 MIL PDIP 28 LEAD

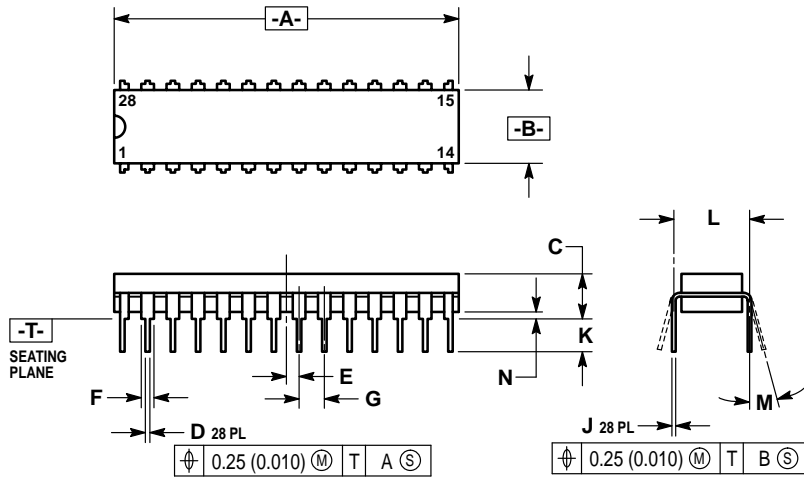

NOTES:

1. DIMENSIONING AND TOLERANCING PER ANSI Y14.5M, 1982.
2. CONTROLLING DIMENSION: INCH.
3. DIMENSION L TO CENTER OF LEAD WHEN FORMED PARALLEL.
4. DIMENSION A AND B DOES NOT INCLUDE MOLD FLASH. MAXIMUM MOLD FLASH 0.25 (0.010).

DIM	MILLIMETERS		INCHES	
	MIN	MAX	MIN	MAX
A	34.55	34.79	1.360	1.370
B	7.12	7.62	0.280	0.300
C	3.81	4.57	0.150	0.180
D	0.39	0.53	0.015	0.021
E	1.27 BSC			
F	1.15	1.39	0.045	0.055
G	2.54 BSC			
J	0.21	0.30	0.008	0.012
K	3.18	3.42	0.125	0.135
L	7.62 BSC			
M	0°	15°	0°	15°
N	0.51	1.01	0.020	0.040

CASE 810B-03 300 MIL SOJ 28 LEAD

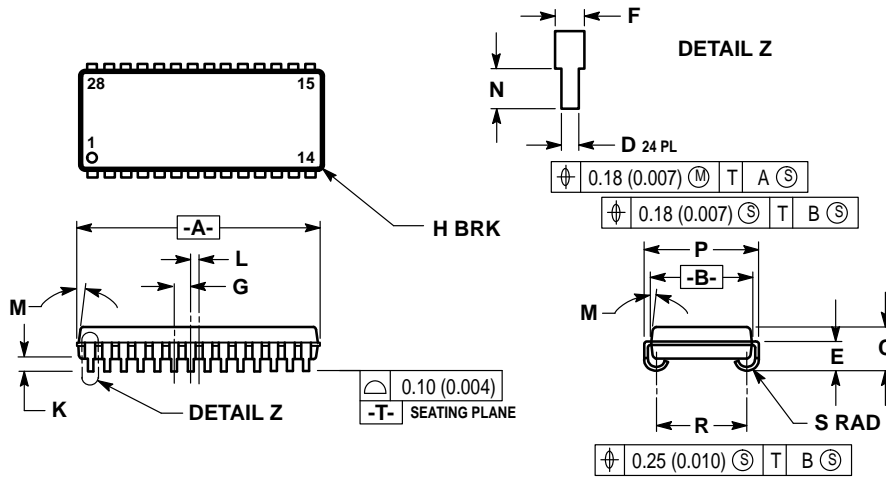

NOTES:

1. DIMENSIONING AND TOLERANCING PER ANSI Y14.5M, 1982.
2. DIMENSION A & B DO NOT INCLUDE MOLD PROTRUSION. MOLD PROTRUSION SHALL NOT EXCEED 0.15 (0.006) PER SIDE.
3. CONTROLLING DIMENSION: INCH.
4. DIM R TO BE DETERMINED AT DATUM -T-.
5. 810B-01 AND -02 OBSOLETE, NEW STANDARD 810B-03.

DIM	MILLIMETERS		INCHES	
	MIN	MAX	MIN	MAX
A	18.29	18.54	0.720	0.730
B	7.50	7.74	0.295	0.305
C	3.26	3.75	0.128	0.148
D	0.39	0.50	0.015	0.020
E	2.24	2.48	0.088	0.098
F	0.67	0.81	0.026	0.032
G	1.27 BSC			
H	—	0.50	—	0.020
K	0.89	1.14	0.035	0.045
L	0.64 BSC			
M	0°	10°	0°	10°
N	0.76	1.14	0.030	0.045
P	8.38	8.64	0.330	0.340
R	6.60	6.86	0.260	0.270
S	0.77	1.01	0.030	0.040

Motorola reserves the right to make changes without further notice to any products herein. Motorola makes no warranty, representation or guarantee regarding the suitability of its products for any particular purpose, nor does Motorola assume any liability arising out of the application or use of any product or circuit, and specifically disclaims any and all liability, including without limitation consequential or incidental damages. "Typical" parameters can and do vary in different applications. All operating parameters, including "Typicals" must be validated for each customer application by customer's technical experts. Motorola does not convey any license under its patent rights nor the rights of others. Motorola products are not designed, intended, or authorized for use as components in systems intended for surgical implant into the body, or other applications intended to support or sustain life, or for any other application in which the failure of the Motorola product could create a situation where personal injury or death may occur. Should Buyer purchase or use Motorola products for any such unintended or unauthorized application, Buyer shall indemnify and hold Motorola and its officers, employees, subsidiaries, affiliates, and distributors harmless against all claims, costs, damages, and expenses, and reasonable attorney fees arising out of, directly or indirectly, any claim of personal injury or death associated with such unintended or unauthorized use, even if such claim alleges that Motorola was negligent regarding the design or manufacture of the part. Motorola and  are registered trademarks of Motorola, Inc. Motorola, Inc. is an Equal Opportunity/Affirmative Action Employer.

Literature Distribution Centers:

USA/EUROPE: Motorola Literature Distribution; P.O. Box 20912; Phoenix, Arizona 85036.

JAPAN: Nippon Motorola Ltd.; 4-32-1, Nishi-Gotanda, Shinagawa-ku, Tokyo 141, Japan.

ASIA PACIFIC: Motorola Semiconductors H.K. Ltd.; Silicon Harbour Center, No. 2 Dai King Street, Tai Po Industrial Estate, Tai Po, N.T., Hong Kong.



MOTOROLA

◇ CODELINE TO BE PLACED HERE

MCM6206D/D

