

The RF Line VHF Power Amplifier

The MHW105 is designed specifically for portable radio applications. The MHW105 is capable of 5.0 watts power output, operates from a 7.5 volt supply and requires only 1.0 mW of RF input power.

- Specified 7.5 Volt Characteristics:
 - RF Input Power — 1.0 mW (0 dBm)
 - RF Output Power — 5.0 W
 - Minimum Gain — 37 dB
 - Harmonics — -40 dBc Max @ 2 f₀
- 50 Ohm Input/Output Impedances
- Guaranteed Stability and Ruggedness
- Epoxy Glass PCB Construction Gives Consistent Performance and Reliability

MHW105

5.0 W
68 to 88 MHz
VHF POWER
AMPLIFIER

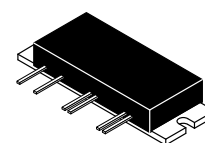

CASE 301K-02, STYLE 3

MAXIMUM RATINGS (Flange Temperature = 25°C)

Rating	Symbol	Value	Unit
DC Supply Voltage	V _{S3}	9.0	Vdc
DC Control & Bias Voltage	V _{S1,2}	9.0	Vdc
DC Control Voltage	V _{cont}	9.0	Vdc
RF Input Power	P _{in}	5.0	mW
RF Output Power (V _{cont} = 9.0 Vdc)	P _{out}	7.0	W
Operating Case Temperature Range	T _C	-30 to +100	°C
Storage Temperature Range	T _{stg}	-30 to +100	°C

ELECTRICAL CHARACTERISTICS (V_{S1} = V_{S2} = V_{S3} = 7.5 Vdc; V_{cont} ≤ 7.0 Vdc; T_C = +25°C, 50 Ω system, unless otherwise noted)

Characteristic	Symbol	Min	Max	Unit
Frequency Range	BW	68	88	MHz
Power Gain (P _{out} = 5.0 W) (1)	G _p	37	—	dB
Control Voltage (P _{in} = 1.0 mW; P _{out} = 5.0 W) (1)	V _{cont}	—	7.0	Vdc
Efficiency (P _{out} = 5.0 W) (1)	η	40	—	%
Harmonics (P _{out} = 5.0 W) (1) 2 f ₀ , 3 f ₀	—	—	-40	dBc
Input VSWR (P _{out} = 5.0 W) (1)	VSWR _{in}	—	2.0:1	—
Load Mismatch (V _{S1} = V _{S2} = V _{S3} = 9.0 Vdc; Load VSWR = 20:1; P _{out} = 5.0 W) (1)	ψ	No Degradation in Power Output Before and After Test		
Stability (P _{in} = 1.0 to 3.0 mW; V _{S1} = V _{S2} = V _{S3} = 6.0 to 9.0 Vdc; P _{out} = 1.0 W to 5.0 W; Load VSWR = 8:1, All Phase Angles) (1)	—	All Spurious Outputs More Than 60 dB Below Desired Signal		
Quiescent Current (V _{S1} = V _{S2} = V _{S3} = 7.5 Vdc; V _{cont} = 7.0 Vdc; P _{in} = 0)	I _Q	—	200	mA

NOTE:

- Adjust V_{cont} for specified P_{out}

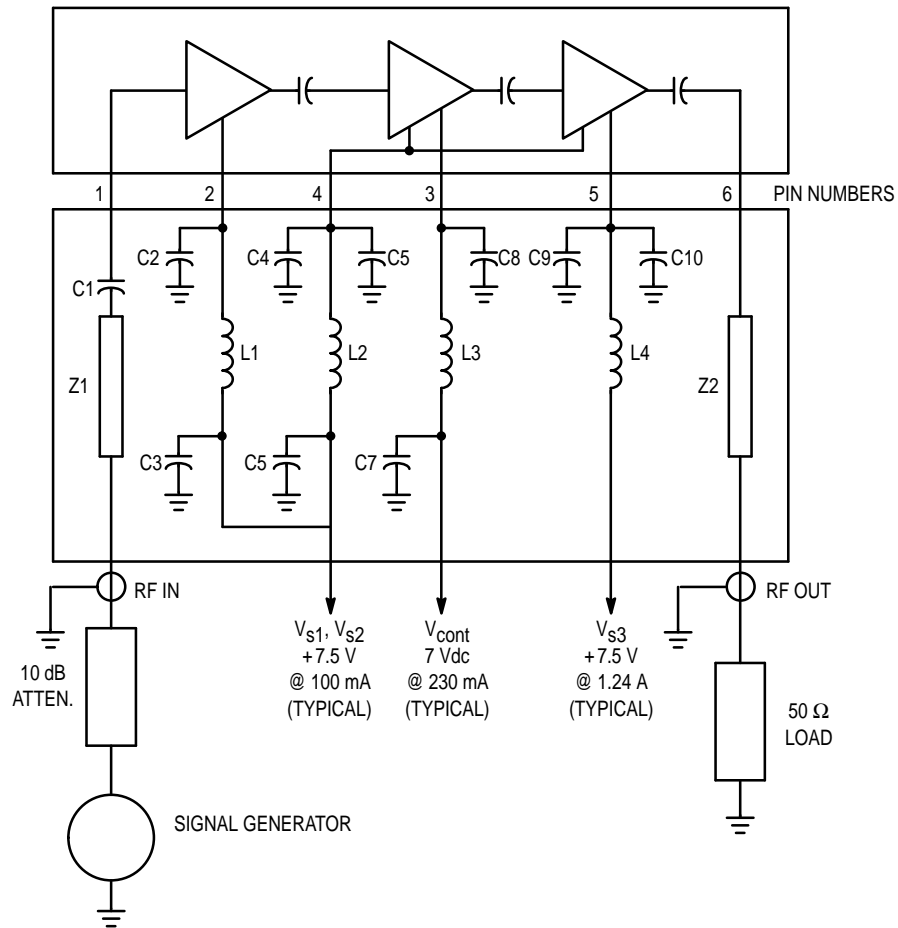

C1, C2, C3, C4, C6, C7, C8, C9 — 18,000 pF CHIP
 C5, C10 — 3.3 μ F TANTALUM CHIP
 L1, L2, L3, L4 — 0.2 μ H
 Z1, Z2 — 50 Ω MICROSTRIP LINE

Figure 1. VHF Power Module Test Circuit Diagram

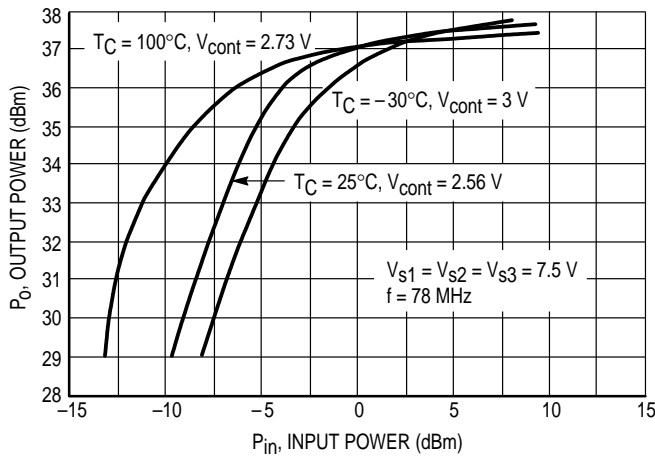

Figure 2. Output Power versus Input Power

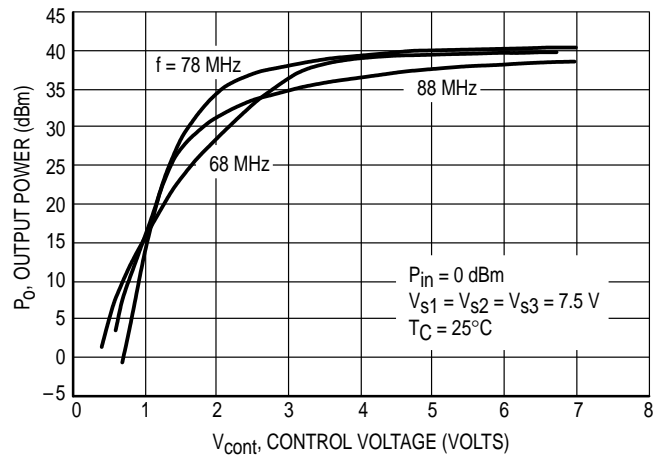

Figure 3. Output Power versus Control Voltage

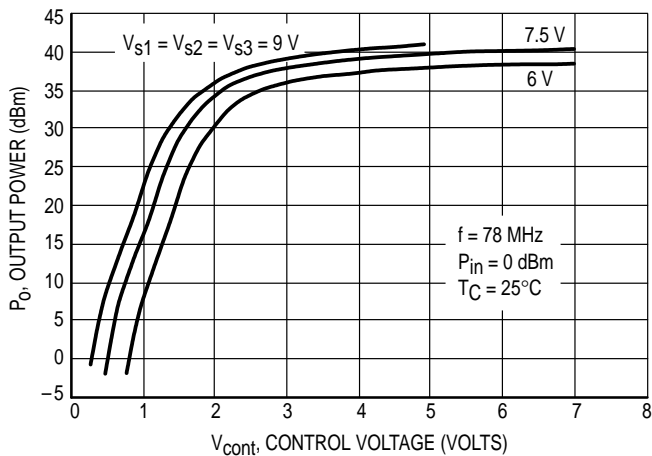

Figure 4. Output Power versus Control Voltage

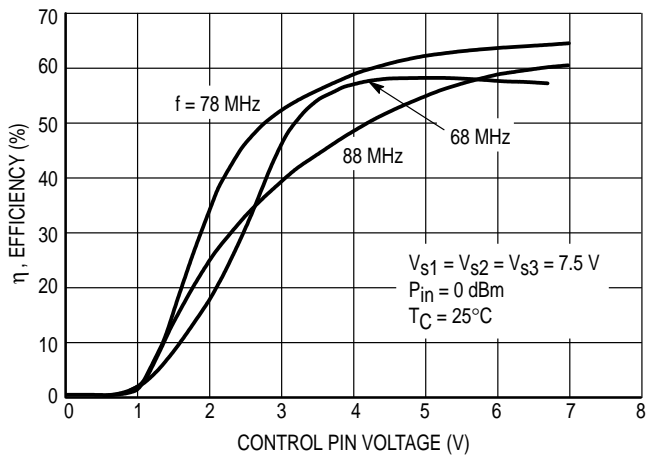

Figure 5. Efficiency versus Control Voltage

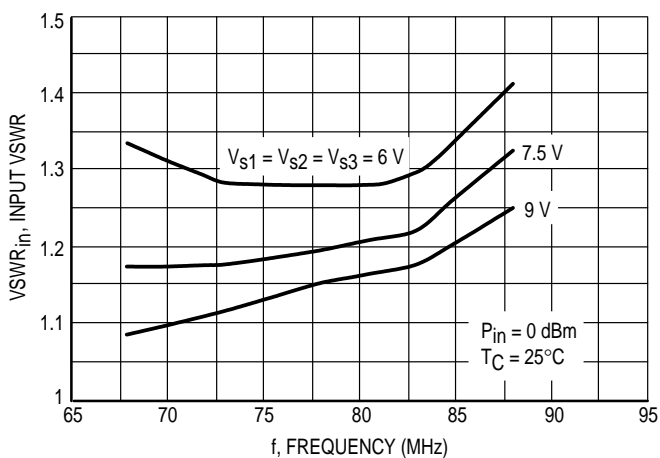

Figure 6. Input VSWR versus Frequency

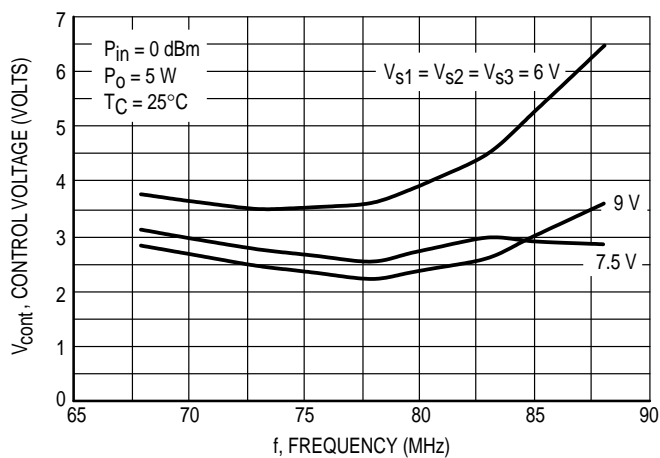

Figure 7. Control Voltage versus Frequency

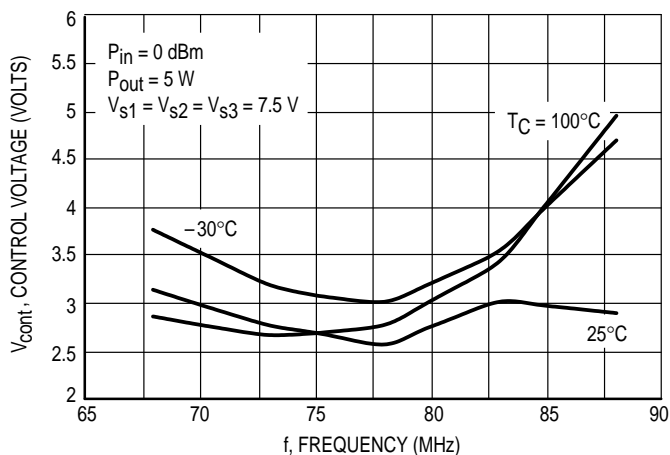
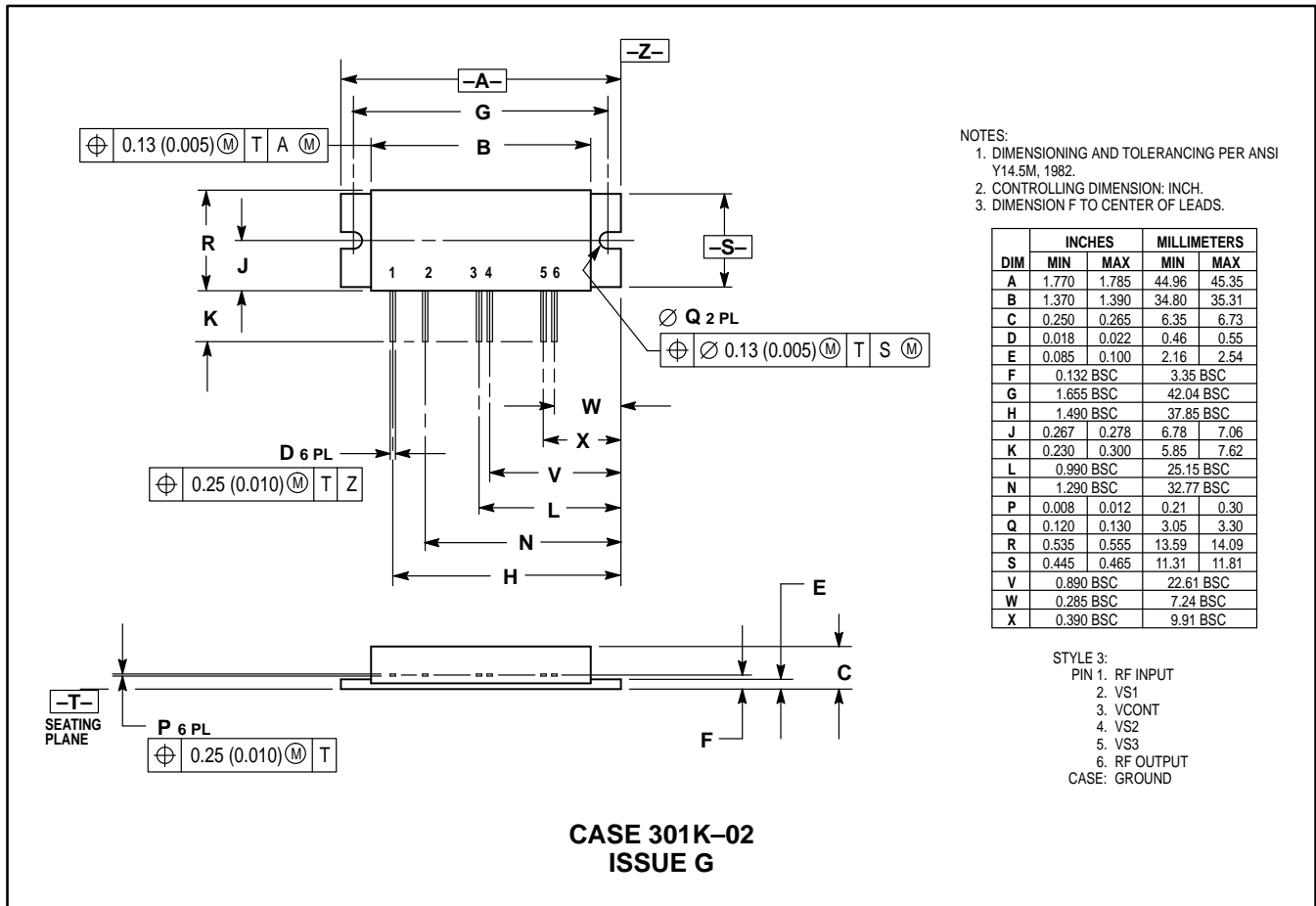

Figure 8. Control Voltage versus Frequency

PACKAGE DIMENSIONS



Motorola reserves the right to make changes without further notice to any products herein. Motorola makes no warranty, representation or guarantee regarding the suitability of its products for any particular purpose, nor does Motorola assume any liability arising out of the application or use of any product or circuit, and specifically disclaims any and all liability, including without limitation consequential or incidental damages. "Typical" parameters can and do vary in different applications. All operating parameters, including "Typicals" must be validated for each customer application by customer's technical experts. Motorola does not convey any license under its patent rights nor the rights of others. Motorola products are not designed, intended, or authorized for use as components in systems intended for surgical implant into the body, or other applications intended to support or sustain life, or for any other application in which the failure of the Motorola product could create a situation where personal injury or death may occur. Should Buyer purchase or use Motorola products for any such unintended or unauthorized application, Buyer shall indemnify and hold Motorola and its officers, employees, subsidiaries, affiliates, and distributors harmless against all claims, costs, damages, and expenses, and reasonable attorney fees arising out of, directly or indirectly, any claim of personal injury or death associated with such unintended or unauthorized use, even if such claim alleges that Motorola was negligent regarding the design or manufacture of the part. Motorola and are registered trademarks of Motorola, Inc. Motorola, Inc. is an Equal Opportunity/Affirmative Action Employer.

How to reach us:

USA / EUROPE: Motorola Literature Distribution;
P.O. Box 20912; Phoenix, Arizona 85036. 1-800-441-2447

JAPAN: Nippon Motorola Ltd.; Tatsumi-SPD-JLDC, Toshikatsu Otsuki,
6F Seibu-Butsuryu-Center, 3-14-2 Tatsumi Koto-Ku, Tokyo 135, Japan. 03-3521-8315

MFAX: RMFAX0@email.sps.mot.com - TOUCHTONE (602) 244-6609
INTERNET: http://Design-NET.com

HONG KONG: Motorola Semiconductors H.K. Ltd.; 8B Tai Ping Industrial Park,
51 Ting Kok Road, Tai Po, N.T., Hong Kong. 852-26629298

