

The RF Line UHF Silicon FET Power Amplifier

Designed for 7.5 volt UHF power amplifier applications in industrial and commercial equipment primarily for hand portable radios.

- Specified 7.5 Volt Characteristics:
 - RF Input Power: 1 mW (0 dBm)
 - RF Output Power: 7 W
 - Minimum Gain ($V_{cont} = 7 V$): 38.5 dB
 - Harmonics: -40 dBc Max @ $2 f_0$
- Meets European Transient Specification (ETS 300 113)
- Epoxy Glass PCB Construction Gives Consistent Performance and Reliability
- 50 Ω Input/Output Impedances
- Guaranteed Stability and Ruggedness

MHW2707-1

7 W
403-440 MHz
UHF POWER AMPLIFIER

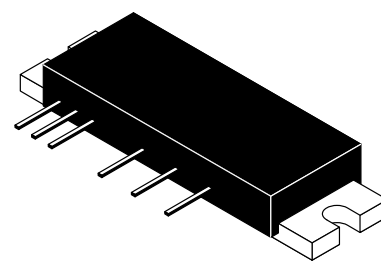

CASE 301AL-01, STYLE 1

MAXIMUM RATINGS (Flange Temperature = 25°C)

Rating	Symbol	Value	Unit
DC Supply Voltage (Pins 2, 4, 5)	$V_{DD1, 2, 3}$	9	Vdc
DC Control Voltage (Pin 3)	V_{cont}	7	Vdc
RF Input Power	P_{in}	2	mW
RF Output Power ($V_{DD1, 2, 3} = 9 V$)	P_{out}	9	W
Operating Case Temperature Range	T_C	-30 to +80	°C
Storage Temperature Range	T_{stg}	-30 to +80	°C

ELECTRICAL CHARACTERISTICS ($V_{DD1} = V_{DD2} = V_{DD3} = 7.5$ Vdc (Pins 2, 4, 5); $T_C = +25^\circ\text{C}$, 50 ohm system unless otherwise noted)

Characteristic	Symbol	Min	Max	Unit
Frequency Range	BW	403	440	MHz
Control Voltage ($P_{out} = 7$ W; $P_{in} = 1$ mW) (1)	V_{cont}	0	7	Vdc
Quiescent Current ($V_{DD1} = V_{DD2} = V_{DD3} = 7.5$ Vdc; $P_{in} = 0$ mW, $V_{cont} = 0$ Vdc)	—	—	1	mA
Power Gain ($P_{out} = 7$ W, $V_{cont} = 7$ Vdc)	G_p	38.5	—	dB
Efficiency ($P_{out} = 7$ W; $P_{in} = 1$ mW) (1)	η	40	—	%
Harmonics ($P_{out} = 7$ W; $P_{in} = 1$ mW) (1) $2 f_o$	—	—	-40	dBc
Input VSWR ($P_{out} = 7$ W; $P_{in} = 1$ mW, 50 Ω Ref.) (1)	$VSWR_{in}$	—	2:1	—
Control Current ($V_{DD1} = V_{DD2} = V_{DD3} = 7.5$ Vdc; $P_{in} = 1$ mW) (1)	I_{cont}	—	2	mA
Load Mismatch Stress ($V_{DD1} = V_{DD2} = V_{DD3} = 9$ Vdc; $P_{in} = 2$ mW; $P_{out} = 9$ W; Load VSWR = 10:1, All Phase Angles at Frequency of Test) (1)	ψ	No Degradation in Output Power Before & After Test		
Stability ($P_{in} = 1-2$ mW; $V_{DD1} = V_{DD2} = V_{DD3} = 6-9$ Vdc; P_{out} = between 0.1 mW and 9 W; Load VSWR = 8:1, All Phase Angles at Frequency of Test) (1)	—	All Spurious Outputs More Than 60 dB Below Desired Signal		

(1) Adjust V_{cont} for Specified P_{out} .

MHW2707-1 CIRCUIT BLOCK DIAGRAM

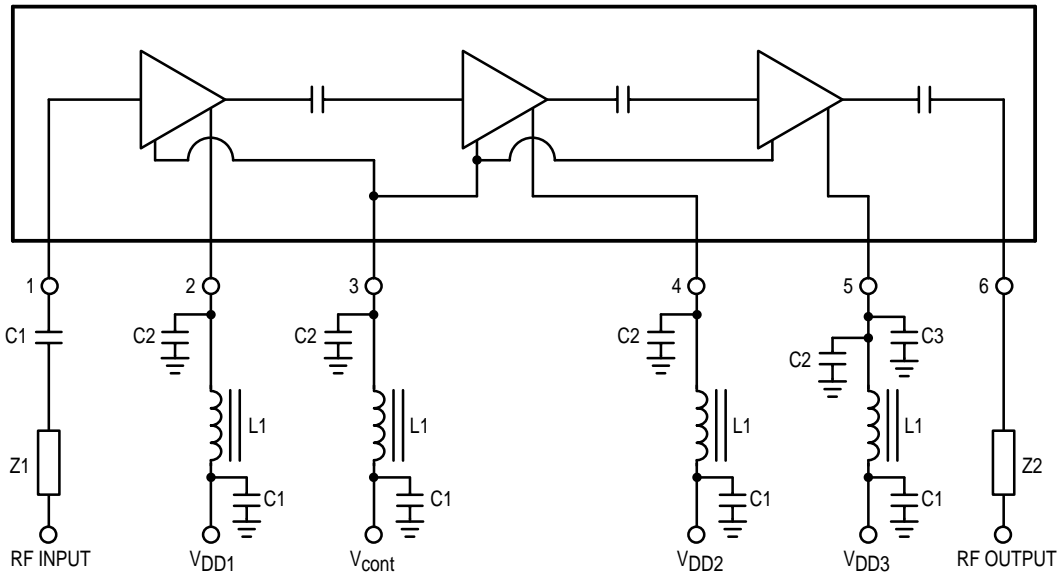

Pin Designations:

Pin 1 — RF Input Power (0 dBm)
 Pin 2 — V_{DD1} (7.5 Vdc)
 Pin 3 — V_{cont} (0 – 7 Vdc)
 Pin 4 — V_{DD2} (7.5 Vdc)
 Pin 5 — V_{DD3} (7.5 Vdc)
 Pin 6 — RF OUT (7 Watts nom.)

Element Values:

$C1 = 0.018 \mu\text{F}$
 $C2 = 0.1 \mu\text{F}$
 $C3 = 3.3 \mu\text{F}$
 $L1 = 0.22 \mu\text{H}$ CHOKE
 $Z1 = Z2 = 50 \Omega$ Microstrip Line

Figure 1. UHF Power Module Test Circuit Schematic and Device Block Diagram

TYPICAL CHARACTERISTICS

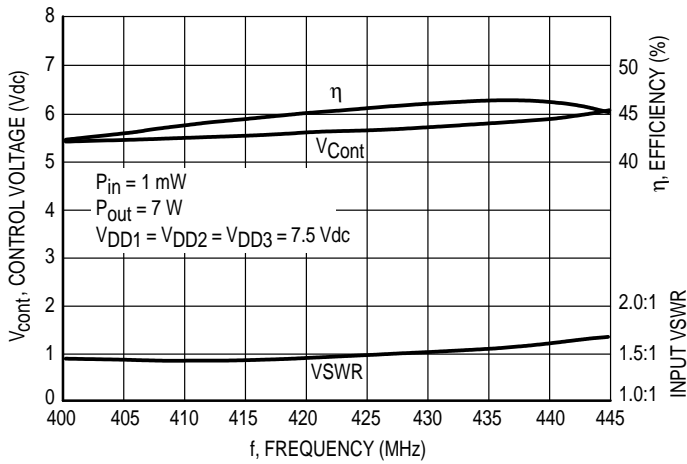

Figure 2. Control Voltage, Efficiency and VSWR versus Frequency

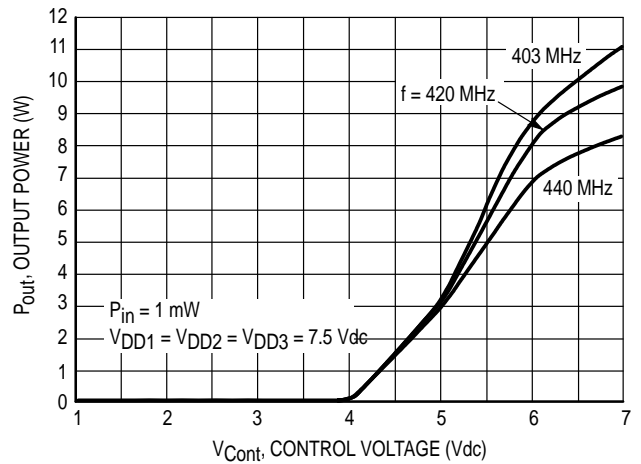

Figure 3. Output Power versus Control Voltage

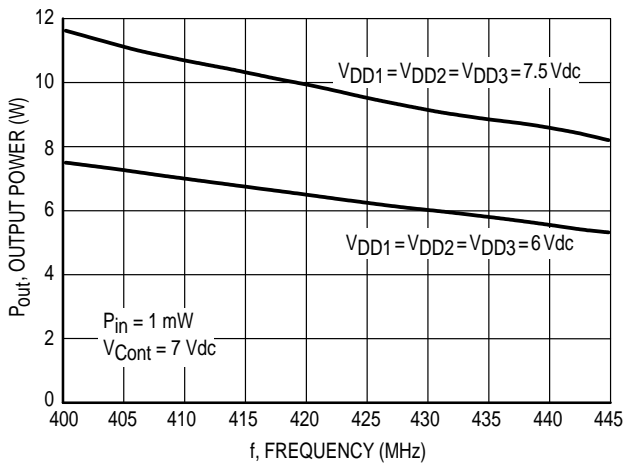

Figure 4. Output Power versus Frequency

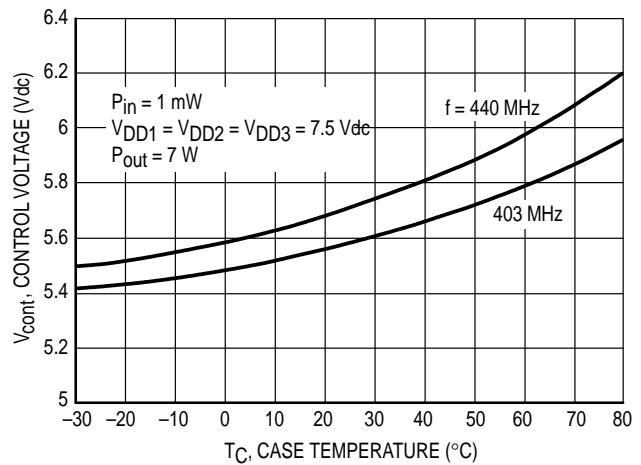

Figure 5. Control Voltage versus Case Temperature

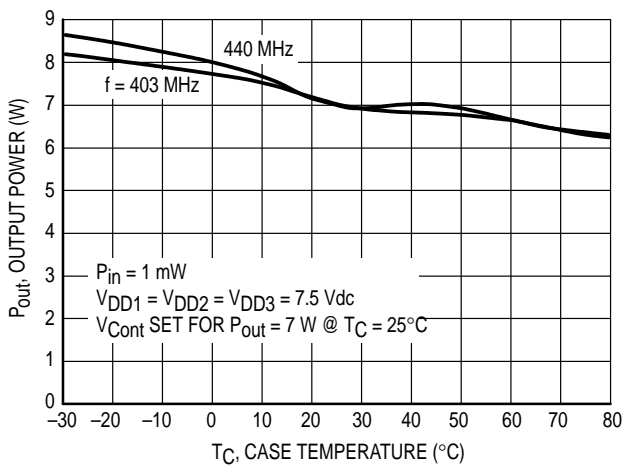

Figure 6. Output Power versus Case Temperature

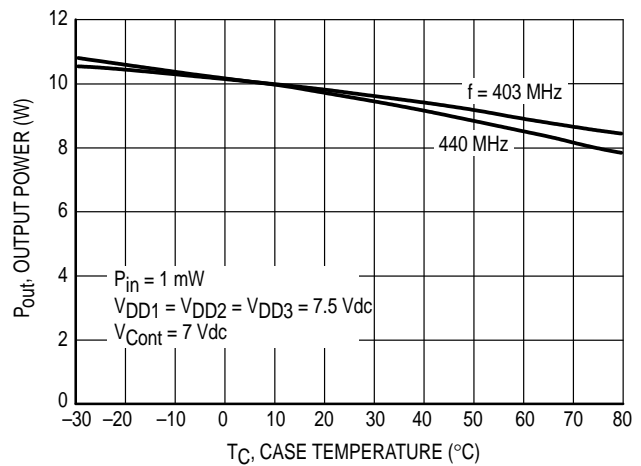
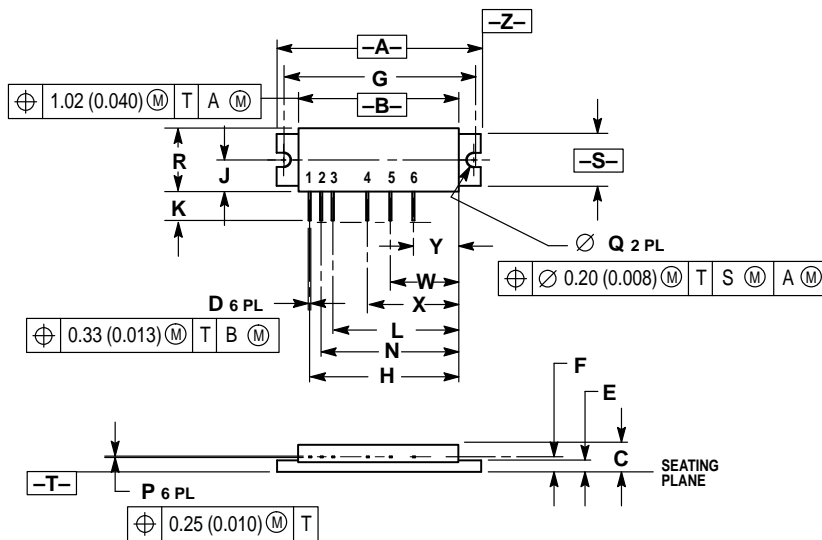

Figure 7. Output Power versus Case Temperature at Maximum Control Voltage

PACKAGE DIMENSIONS



- NOTES:
1. DIMENSIONING AND TOLERANCING PER ANSI Y14.5M, 1982.
 2. CONTROLLING DIMENSION: INCH.
 3. DIMENSION F TO CENTER OF LEADS.
 4. REF INDICATES NON-CONTROLLED DIMENSION FOR REFERENCE USE ONLY.

DIM	INCHES		MILLIMETERS	
	MIN	MAX	MIN	MAX
A	1.760	1.780	44.70	45.21
B	1.370	1.390	34.80	35.31
C	0.245	0.265	6.22	6.73
D	0.017	0.023	0.43	0.58
E	0.080	0.100	2.03	2.54
F	0.132 BSC		3.35 BSC	
G	1.650 BSC		41.91 BSC	
H	1.290 BSC		32.77 BSC	
J	0.266	0.280	6.76	7.11
K	0.230	0.300	5.84	7.62
L	1.090 BSC		27.69 BSC	
N	1.190 BSC		30.25 BSC	
P	0.010 REF		0.25 REF	
Q	0.118	0.132	3.00	3.35
R	0.535	0.555	13.59	14.10
S	0.445	0.465	11.30	11.81
V	0.590 BSC		14.99 BSC	
X	0.790 BSC		20.07 BSC	
X	0.390 BSC		9.91 BSC	

- STYLE 1:
 PIN 1: RF INPUT
 2. VDD1
 3. VCONT
 4. VDD2
 5. VDD3
 6. RF OUTPUT
 CASE: GROUND

CASE 301AL-01 ISSUE 0

Motorola reserves the right to make changes without further notice to any products herein. Motorola makes no warranty, representation or guarantee regarding the suitability of its products for any particular purpose, nor does Motorola assume any liability arising out of the application or use of any product or circuit, and specifically disclaims any and all liability, including without limitation consequential or incidental damages. "Typical" parameters which may be provided in Motorola data sheets and/or specifications can and do vary in different applications and actual performance may vary over time. All operating parameters, including "Typicals" must be validated for each customer application by customer's technical experts. Motorola does not convey any license under its patent rights nor the rights of others. Motorola products are not designed, intended, or authorized for use as components in systems intended for surgical implant into the body, or other applications intended to support or sustain life, or for any other application in which the failure of the Motorola product could create a situation where personal injury or death may occur. Should Buyer purchase or use Motorola products for any such unintended or unauthorized application, Buyer shall indemnify and hold Motorola and its officers, employees, subsidiaries, affiliates, and distributors harmless against all claims, costs, damages, and expenses, and reasonable attorney fees arising out of, directly or indirectly, any claim of personal injury or death associated with such unintended or unauthorized use, even if such claim alleges that Motorola was negligent regarding the design or manufacture of the part. Motorola and are registered trademarks of Motorola, Inc. Motorola, Inc. is an Equal Opportunity/Affirmative Action Employer.

Mfax is a trademark of Motorola, Inc.

How to reach us:

USA/EUROPE/Locations Not Listed: Motorola Literature Distribution;
 P.O. Box 5405, Denver, Colorado 80217. 303-675-2140 or 1-800-441-2447

JAPAN: Nippon Motorola Ltd.: SPD, Strategic Planning Office, 4-32-1,
 Nishi-Gotanda, Shinagawa-ku, Tokyo 141, Japan. 81-3-5487-8488

Mfax™: RMFAX0@email.sps.mot.com – TOUCHTONE 602-244-6609
 – US & Canada ONLY 1-800-774-1848

ASIA/PACIFIC: Motorola Semiconductors H.K. Ltd.; 8B Tai Ping Industrial Park,
 51 Ting Kok Road, Tai Po, N.T., Hong Kong. 852-26629298

INTERNET: <http://motorola.com/sps>

