

The RF Line UHF Silicon FET Power Amplifiers

Designed for 12.5 volt UHF power amplifier applications in industrial and commercial FM equipment operating from 806 to 950 MHz.

- Specified 12.5 Volt Characteristics:
 - RF Input Power: ≤ 250 mW (MHW2821-1)
 ≤ 300 mW (MHW2821-2)
 - RF Output Power: 20 W (MHW2821-1)
18 W (MHW2821-2)
- LDMOS FET Technology
- Epoxy Glass Substrate Eliminates Possibility of Substrate Fracture
- 50 Ω Input/Output Impedance
- Guaranteed Stability and Ruggedness
- Cost Effective

MHW2821-1
MHW2821-2

-1: 20 W, 806-870 MHz
-2: 18 W, 890-950 MHz
RF POWER AMPLIFIER

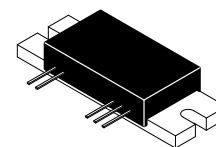

CASE 301AB-02, STYLE 1

MAXIMUM RATINGS (Flange Temperature = 25°C)

Rating	Symbol	Value	Unit
DC Supply Voltages	V_{bias} , V_{S2} , V_{S3}	12.5 16	Vdc
RF Input Power	P_{in}	400	mW
RF Output Power	P_{out}	23	W
Operating Case Temperature Range	T_C	-30 to +100	°C
Storage Temperature Range	T_{stg}	-30 to +100	°C

ELECTRICAL CHARACTERISTICS ($V_{S2} = V_{S3} = 12.5$ Vdc; $V_{bias} = 12.5$ Vdc; $T_C = +25^\circ\text{C}$, 50 Ω system, unless otherwise noted)

Characteristic		Symbol	Min	Max	Unit
Frequency Range	MHW2821-1 MHW2821-2	BW	806 890	870 950	MHz
Input Power ($P_{out} = 20$ W) (1) ($P_{out} = 18$ W) (1)	MHW2821-1 MHW2821-2	P_{in}	— —	250 300	mW
Power Gain ($P_{out} = 20$ W) (1) ($P_{out} = 18$ W) (1)	MHW2821-1 MHW2821-2	G_p	19 17.9	— —	dB
Efficiency (Rated P_{out})		η	35	—	%
Harmonics (Rated P_{out} Reference) (1)		$2f_o$ $3f_o$	— —	-40 -45	dBc
Input VSWR (Rated P_{out}) (1)		VSWR $_{in}$	—	3:1	dB

(1) Adjust P_{in} for specified P_{out} .

(continued)

ELECTRICAL CHARACTERISTICS (continued) ($V_{S2} = V_{S3} = 12.5$ Vdc, $V_{bias} = 12.5$ Vdc, $T_C = +25^\circ\text{C}$, $50\ \Omega$ system, unless otherwise noted)

Characteristic	Symbol	Min	Max	Unit
Load Mismatch Stress ($V_{supply} = 16$ Vdc; $P_{out} = 20$ W for MHW2821-1; $P_{out} = 18$ W for MHW2821-2; Load VSWR = 20:1, All Phase Angles at Frequency of Test) (1)	ψ	No Degradation in Output Power Before and After Test		
Stability ($V_{supply} = 10.8$ to 16 Vdc; $P_{in} = 0$ to 250 mW for MHW2821-1; $P_{in} = 0$ to 300 mW for MHW2821-2; Load VSWR = 4:1, All Phase Angles at Frequency of Test)	—	All Spurious Outputs More than 60 dB Below Desired Signal		
Quiescent Current (With No RF Applied) ($V_{S2} = V_{S3} = 12.5$ Vdc; $V_{bias} = 12.5$ Vdc)	I_{sq}	—	500	mA
Leakage Current (With No RF Applied) ($V_{S2} = V_{S3} = 12.5$ Vdc; $V_{bias} = 0$ Vdc)	I_L	—	0.6	mA
Bias P_{in} Current (Rated P_{out}) (1)	I_{bias}	—	0.8	mA

(1) Adjust P_{in} for specified P_{out} .

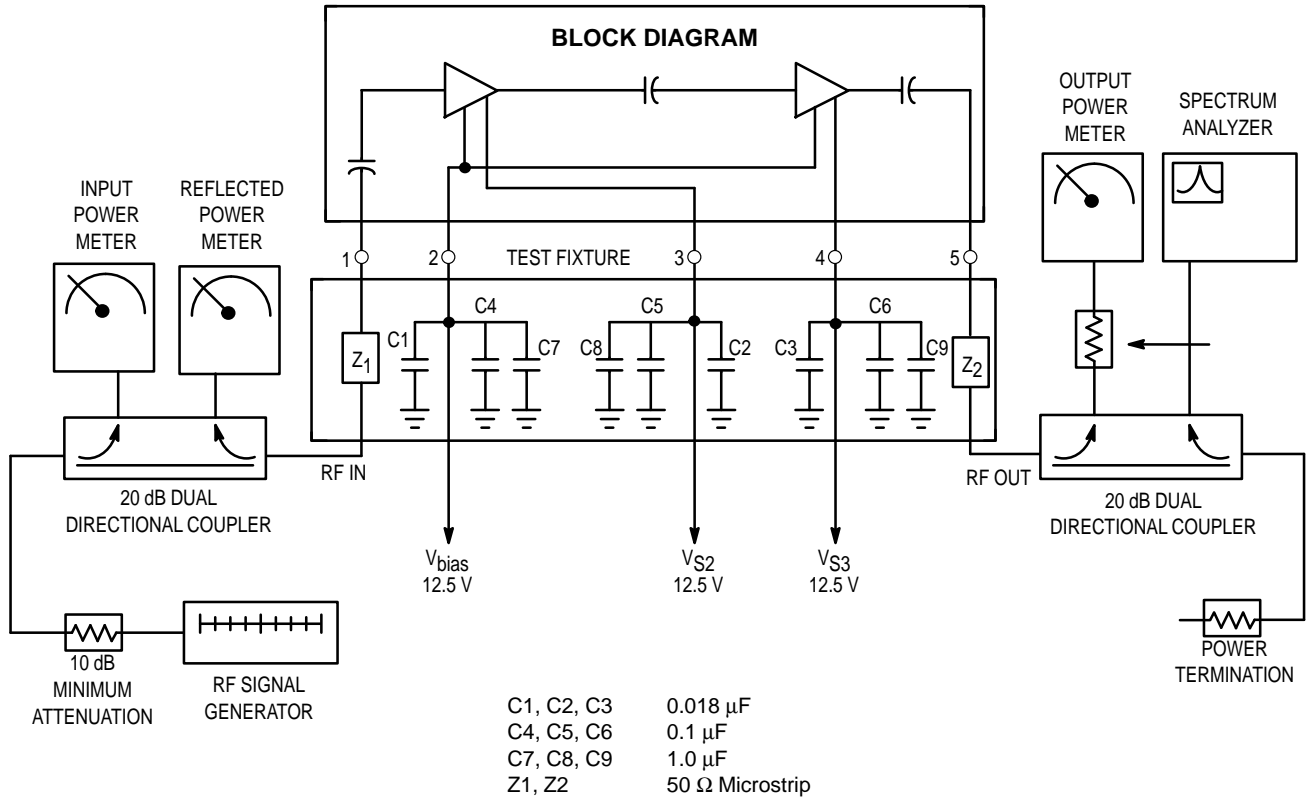

TYPICAL CHARACTERISTICS (MHW2821-1)

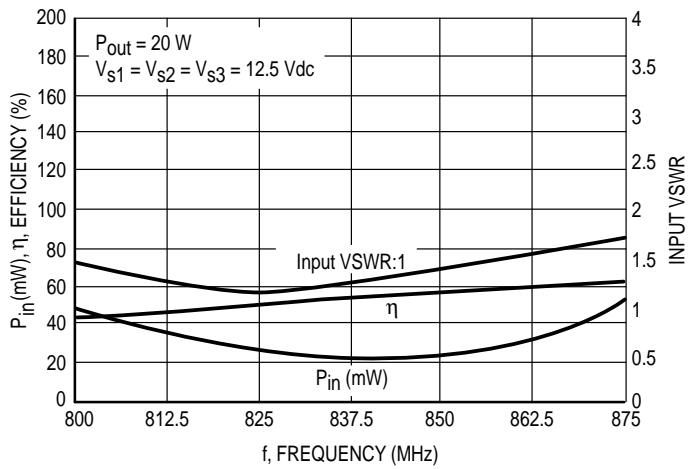

Figure 2. Input Power, Efficiency and VSWR versus Frequency

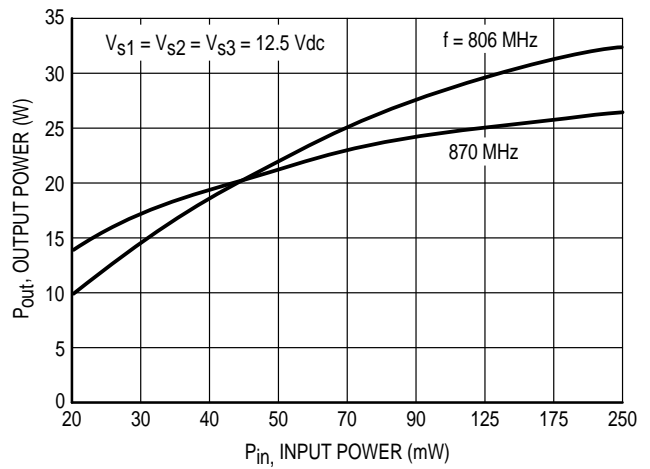

Figure 3. Output Power versus Input Power

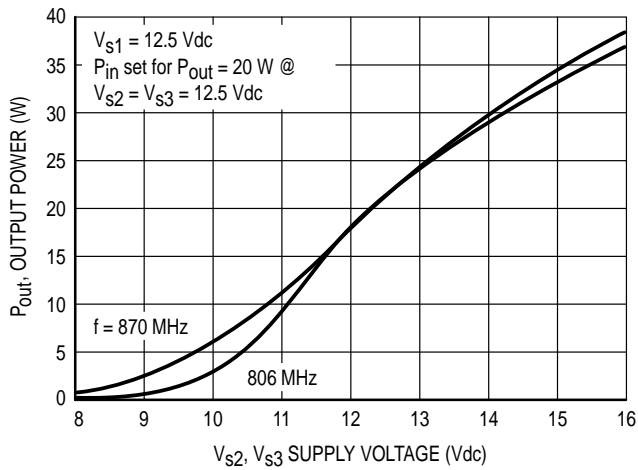

Figure 4. Output Power versus Supply Voltage

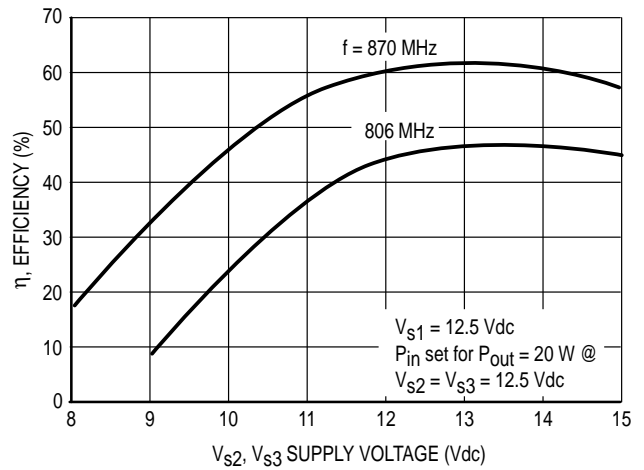

Figure 5. Efficiency versus Supply Voltage

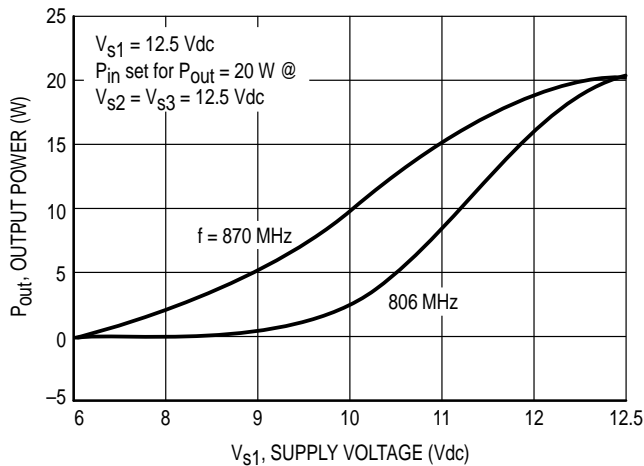

Figure 6. Output Power versus Supply Voltage to First Stage (V_{s1})

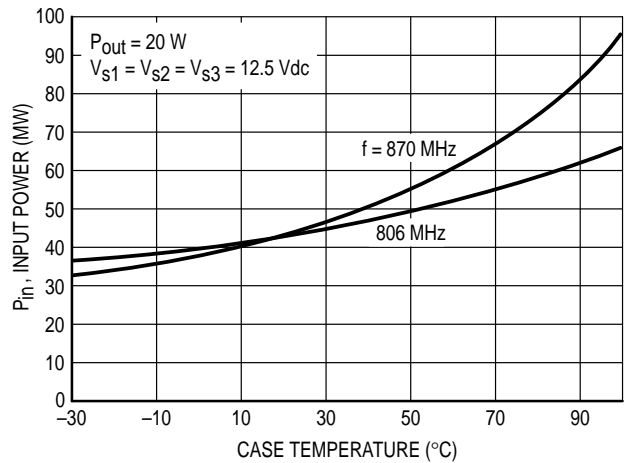

Figure 7. Input Power versus Case Temperature

TYPICAL CHARACTERISTICS (MHW2821-2)

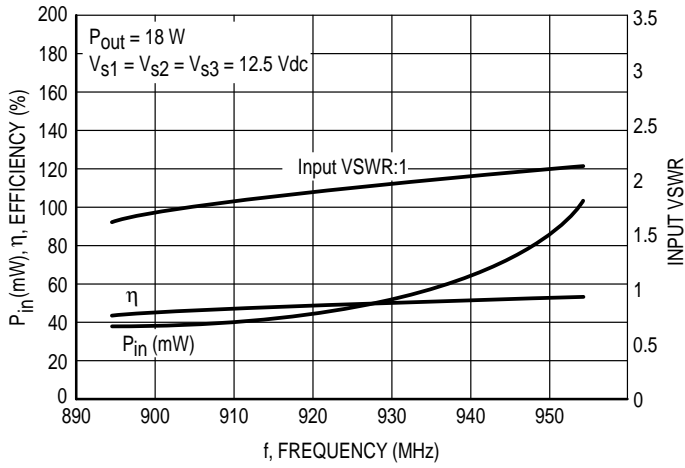

Figure 8. P_{in} VSWR, and Efficiency versus Frequency

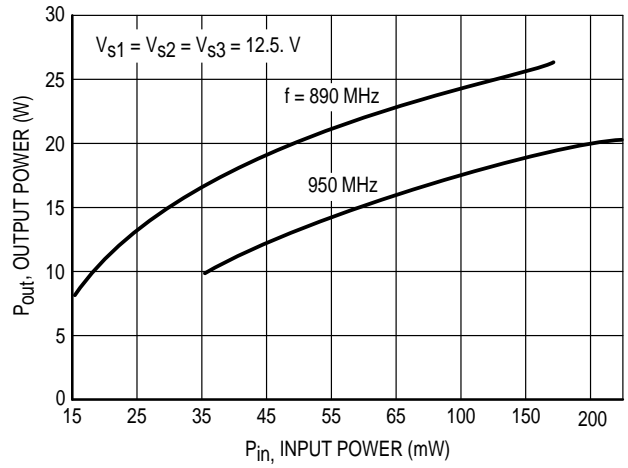

Figure 9. Output Power versus Input Power

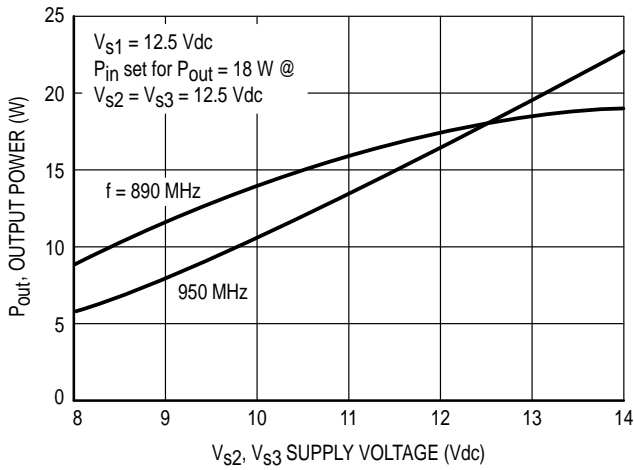

Figure 10. P_{out} versus Supply Voltage

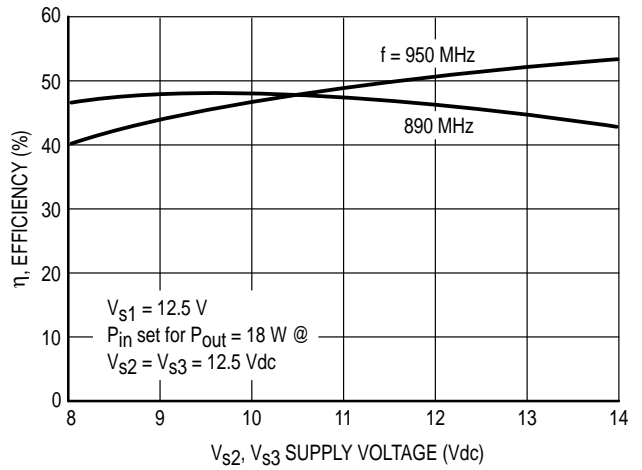
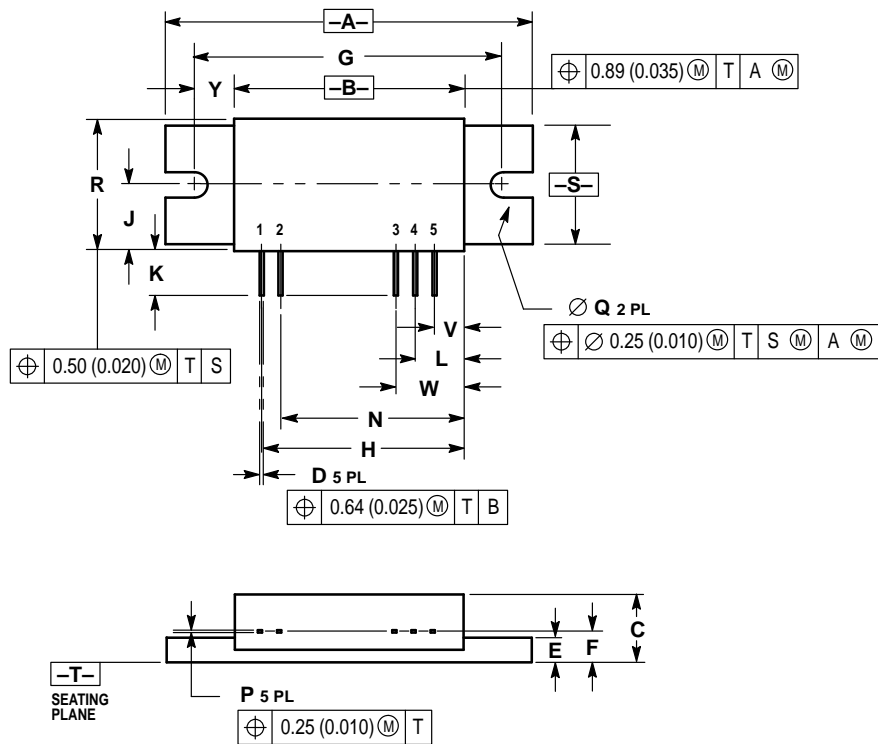

Figure 11. Efficiency versus Supply Voltage

PACKAGE DIMENSIONS



- NOTES:
1. DIMENSIONING AND TOLERANCING PER ANSI Y14.5M, 1982.
 2. CONTROLLING DIMENSION: INCH.
 3. DIMENSION F TO CENTER OF LEADS.
 4. REF INDICATES NON-CONTROLLED DIMENSION FOR REFERENCE USE ONLY.

DIM	INCHES		MILLIMETERS	
	MIN	MAX	MIN	MAX
A	1.890	1.910	48.01	48.51
B	1.170	1.190	29.72	30.23
C	0.350	0.376	8.89	9.55
D	0.018	0.022	0.46	0.56
E	0.120	0.135	3.05	3.43
F	0.165 BSC		4.19 BSC	
G	1.600 BSC		40.64 BSC	
H	1.055 BSC		26.80 BSC	
J	0.336	0.360	8.53	9.14
K	0.225	—	5.72	—
L	0.255 BSC		6.48 BSC	
N	0.955 BSC		24.26 BSC	
P	0.008	0.012	0.20	0.31
Q	0.151	0.161	3.84	4.09
R	0.685	0.705	17.40	17.91
S	0.598	0.612	15.19	15.55
V	0.155 BSC		3.94 BSC	
W	0.355 BSC		9.02 BSC	
Y	0.210 REF		5.33 REF	

- STYLE 1:
 PIN 1: RF INPUT
 2. +DC (BIAS)
 3. +DC (SUPPLY)
 4. +DC (SUPPLY)
 5. RF OUTPUT
 CASE: GROUND

**CASE 301AB-02
 ISSUE F**

Motorola reserves the right to make changes without further notice to any products herein. Motorola makes no warranty, representation or guarantee regarding the suitability of its products for any particular purpose, nor does Motorola assume any liability arising out of the application or use of any product or circuit, and specifically disclaims any and all liability, including without limitation consequential or incidental damages. "Typical" parameters can and do vary in different applications. All operating parameters, including "Typicals" must be validated for each customer application by customer's technical experts. Motorola does not convey any license under its patent rights nor the rights of others. Motorola products are not designed, intended, or authorized for use as components in systems intended for surgical implant into the body, or other applications intended to support or sustain life, or for any other application in which the failure of the Motorola product could create a situation where personal injury or death may occur. Should Buyer purchase or use Motorola products for any such unintended or unauthorized application, Buyer shall indemnify and hold Motorola and its officers, employees, subsidiaries, affiliates, and distributors harmless against all claims, costs, damages, and expenses, and reasonable attorney fees arising out of, directly or indirectly, any claim of personal injury or death associated with such unintended or unauthorized use, even if such claim alleges that Motorola was negligent regarding the design or manufacture of the part. Motorola and  are registered trademarks of Motorola, Inc. Motorola, Inc. is an Equal Opportunity/Affirmative Action Employer.

How to reach us:

USA / EUROPE: Motorola Literature Distribution;
P.O. Box 20912; Phoenix, Arizona 85036. 1-800-441-2447

JAPAN: Nippon Motorola Ltd.; Tatsumi-SPD-JLDC, Toshikatsu Otsuki,
6F Seibu-Butsuryu-Center, 3-14-2 Tatsumi Koto-Ku, Tokyo 135, Japan. 03-3521-8315

MFAX: RMFAX0@email.sps.mot.com – TOUCHTONE (602) 244-6609
INTERNET: <http://Design-NET.com>

HONG KONG: Motorola Semiconductors H.K. Ltd.; 8B Tai Ping Industrial Park,
51 Ting Kok Road, Tai Po, N.T., Hong Kong. 852-26629298



MOTOROLA



MHW2821/D

