

The RF Line UHF Power Amplifiers

... designed specifically for portable radio applications. The MHW804 Series is capable of wide power range control, operates from a 7.5 volt supply and requires only 1.0 mW of RF input power.

- MHW804-1 — 800 to 870 MHz
MHW804-2 — 896 to 940 MHz
- Specified 7.5 Volt Characteristics:
 - RF Input Power — 1.0 mW (0 dBm)
 - RF Output Power — 4.0 W
 - Minimum Gain — 36 dB
 - Harmonics — -45 dBc Max @ 2.0 f_0
- 50 Ohm Input/Output Impedances
- Guaranteed Stability and Ruggedness
- Circuit board photomaster available upon request by contacting RF Tactical Marketing in Phoenix, AZ.

MHW804-1
MHW804-2

4.0 WATTS
800 to 940 MHz
RF POWER
AMPLIFIERS

MAXIMUM RATINGS (Flange Temperature = 25°C)

Rating	Symbol	Value	Unit
DC Supply Voltage	V_s	10	Vdc
DC Control Voltage	V_{cont}	4.0	Vdc
RF Input Power	P_{in}	5.0	mW
RF Output Power	P_{out}	6.0	W
Operating Case Temperature Range	T_C	-30 to +100	°C
Storage Temperature Range	T_{stg}	-30 to +100	°C

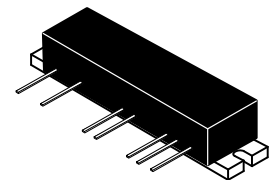

CASE 301F-03, STYLE 1

ELECTRICAL CHARACTERISTICS ($T_C = +25^\circ\text{C}$, 50 ohm system, unless otherwise noted)

Characteristic	Symbol	Min	Max	Unit
Frequency Range	MHW804-1 MHW804-2	800 896	870 940	MHz
Power Gain ($V_{s1} = V_{s2} = V_{s3} = V_{s4} = V_{s5} = 7.5\text{ V}$; $V_{cont} = 3.75\text{ V}$)	G_p	36	—	dB
Control Voltage ($P_{in} = 0\text{ dBm}$, $P_{out} = 4.0\text{ W}$, $V_{s1} = V_{s2} = V_{s3} = V_{s4} = V_{s5} = 7.5\text{ V}$, Adjust V_{cont} for specified P_{out})	V_{cont}	—	3.75	Vdc
Efficiency (Same condition as for V_{cont})	η	32	—	%
Current Drain (Same conditions as for V_{cont})	I_D	—	210	mA
	$I_{s1} + I_{s4}$ (Pins 2, 5)	—	1430	
	$I_{s2} + I_{s3} + I_{s5}$ (Pins 3, 4, 6)	—	0.2	
	$I_{control}$ (Pin 1)	—	0.2	
Input VSWR (Same conditions as for V_{cont})	$VSWR_{in}$	—	2.0:1	—
Harmonic Content (Same conditions as for V_{cont})		—	-45	dBc
	2.0 f_0	—	-50	
	3.0 f_0	—	-50	
Leakage Current — $I_{s2} + I_{s3} + I_{s5}$ ($V_{s2} = V_{s3} = V_{s5} = 7.5\text{ V}$; $V_{s1} = V_{s4} = 0\text{ V}$, $V_{cont} = 0\text{ V}$; $P_{in} = 0\text{ mW}$)	I_L	—	0.3	mA
Standby Current — $I_{s1} + I_{s4}$ ($V_{s1} = V_{s2} = V_{s3} = V_{s4} = V_{s5} = 7.5\text{ V}$, $V_{cont} = 4.0\text{ V}$; $P_{in} = 0\text{ mW}$)	I_S	—	220	mA
Load Mismatch Stress ($V_{s1} = V_{s2} = V_{s3} = V_{s4} = V_{s5} = 9.0\text{ V}$; $P_{in} = 2.0\text{ mW}$; $P_{out} = 6.0\text{ W}$; Load VSWR = 20:1, All Phase Angles. Adjust V_{cont} for Specified P_{out})	ψ	No Degradation in Output Power		
Stability ($V_{s1} = V_{s2} = V_{s3} = V_{s4} = V_{s5} = 6.0\text{ to }9.0\text{ V}$; $P_{IN} = -1.0\text{ dBm to }+3.0\text{ dBm}$; $P_{out} = 1.0\text{ W to }4.0\text{ W}$; Load VSWR = 6:1, All Phase Angles; Adjust V_{cont} for Specified P_{out})	—	All Spurious Outputs More Than 60 dB Below Desired Signal		

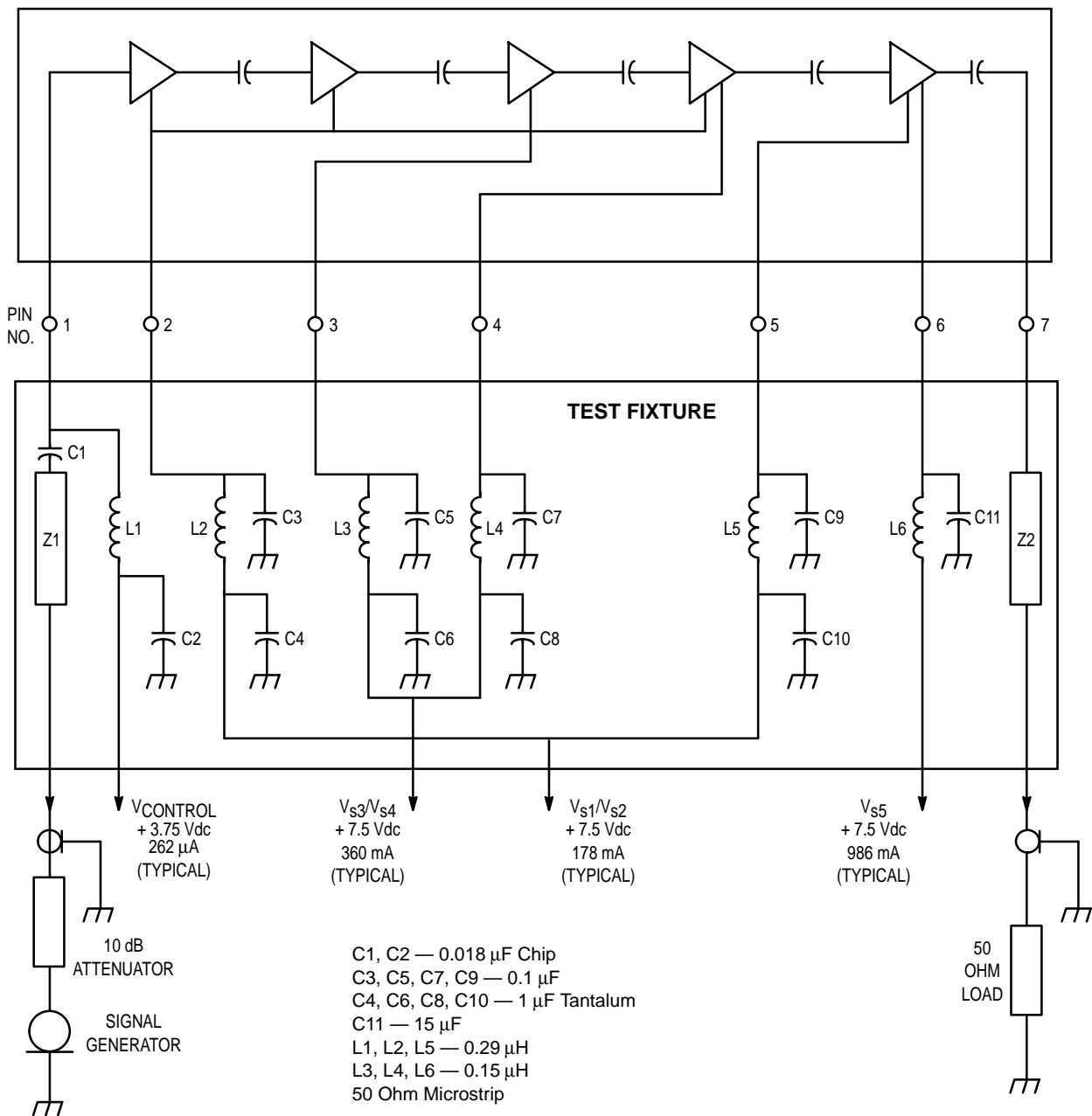

Figure 1. Power Module Test System Block Diagram

TYPICAL CHARACTERISTICS

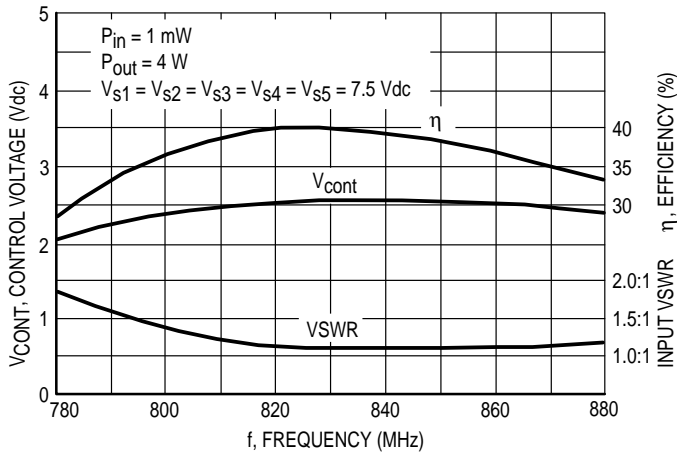

Figure 2. Control Voltage, Efficiency and VSWR versus Frequency

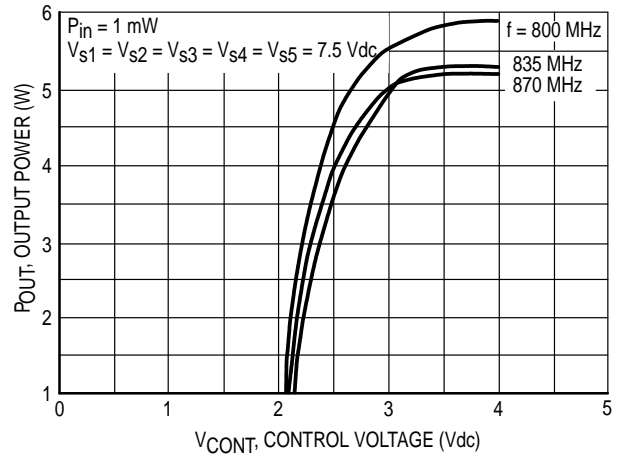

Figure 3. Output Power versus Control Voltage

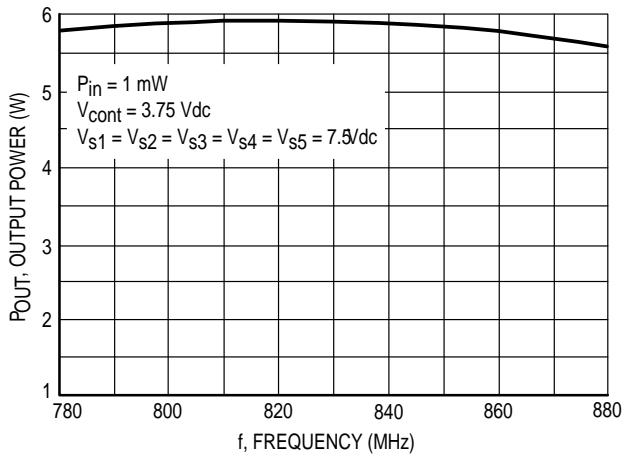

Figure 4. Output Power versus Frequency

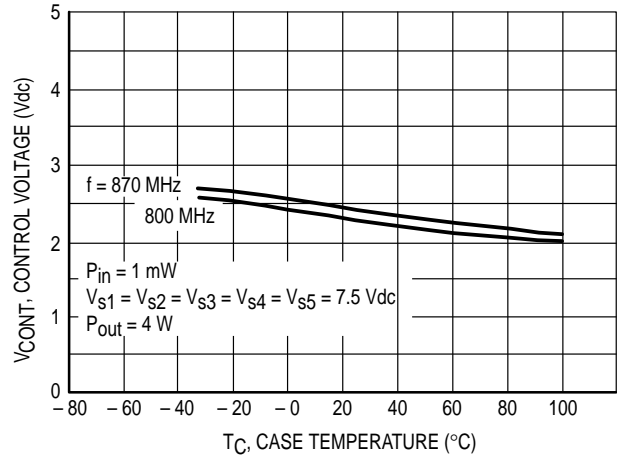

Figure 5. Control Voltage Case Temperature

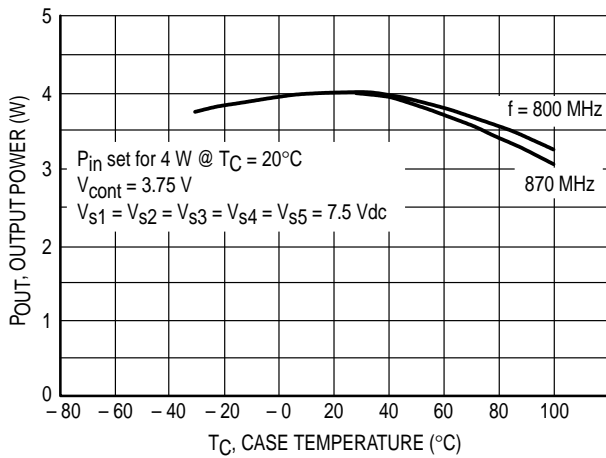

Figure 6. Output Power versus Case Temperature

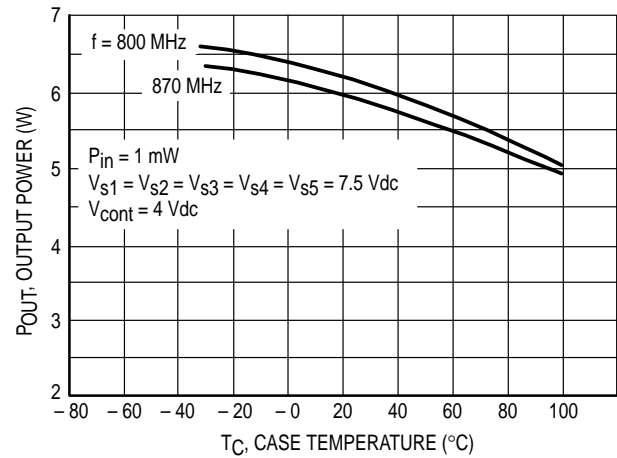

Figure 7. Output Power versus Case Temperature at Maximum Control Voltage

APPLICATIONS INFORMATION

NOMINAL OPERATION

All electrical specifications are based on the nominal conditions of $V_{S1} = V_{S2} = V_{S3} = V_{S4} = V_{S5} = 7.5$ Vdc (Pins 2, 3, 4, 5, 6) and P_{Out} equal to 4.0 watts. With these conditions, maximum current density on any device is 1.5×10^5 A/cm² and maximum die temperature with 100°C case operating temperature is 165°C. While the modules are designed to have excess gain margin with ruggedness, operation of these units outside the limits of published specifications is not recommended unless prior communications regarding intended use have been made with the factory representative.

GAIN CONTROL

The module output should be limited to 4.0 watts. The preferred method of power output control is to fix $V_{S1} = V_{S2} = V_{S3} = V_{S4} = V_{S5} = 7.5$ Vdc (Pins 2, 3, 4, 5, 6), P_{In} (Pin 1) at 1.0 mW, and vary V_{Cont} (Pin 1) voltage.

DECOUPLING

Due to the high gain of the three stages and the module size limitation, external decoupling networks require careful consideration. Pins 2, 3, 4, and 6 are internally bypassed with a 0.018 μ F chip capacitor which is effective for frequencies from 5.0 MHz through 925 MHz. For bypassing frequencies below 5.0 MHz, networks equivalent to that shown in Figure 1 are recommended. Inadequate decoupling will result in spurious outputs at certain operating frequencies and certain phase angles of input and output VSWR.

LOAD MISMATCH

During final test, each module is load mismatch tested in a fixture having the identical decoupling networks described in Figure 1. Electrical conditions are $V_{S1} = V_{S2} = V_{S3} = V_{S4} = V_{S5}$ equal to 9.0 V, VSWR equal to 20:1, and output power equal to 6.0 watts.

PACKAGE DIMENSIONS

- NOTES:
1. DIMENSIONING AND TOLERANCING PER ANSI Y14.5M, 1982.
 2. CONTROLLING DIMENSION: INCH.
 3. DIMENSION F TO CENTER OF LEADS.

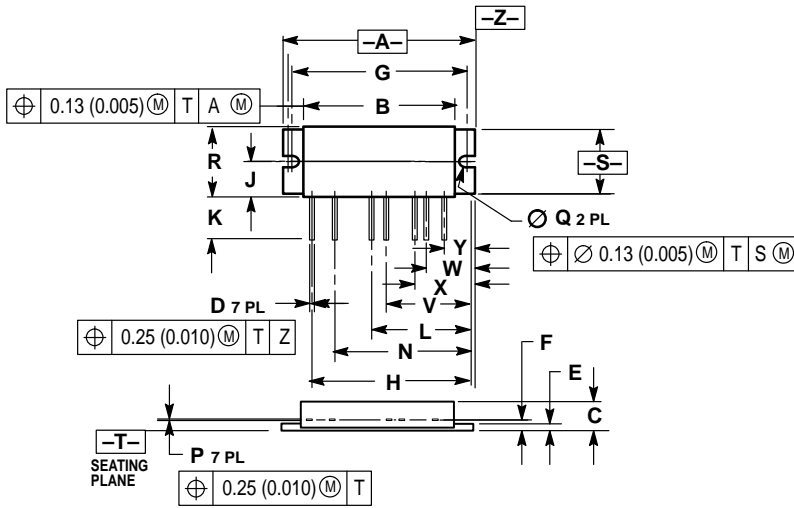

DIM	INCHES		MILLIMETERS	
	MIN	MAX	MIN	MAX
A	2.380	2.395	60.46	6.083
B	1.970	1.990	50.04	50.54
C	0.250	0.265	6.35	6.73
D	0.018	0.022	0.46	0.55
E	0.085	0.100	2.16	2.54
F	0.132 BSC		3.35 BSC	
G	2.260 BSC		57.40 BSC	
H	2.042 BSC		51.87 BSC	
J	0.267	0.278	6.78	7.06
K	0.230	0.300	5.85	7.62
L	1.242 BSC		31.55 BSC	
N	1.742 BSC		44.25 BSC	
P	0.008	0.012	0.21	0.30
Q	0.120	0.130	3.05	3.30
R	0.535	0.555	13.59	14.09
S	0.445	0.465	11.31	11.81
V	1.142 BSC		29.01 BSC	
W	0.542 BSC		13.77 BSC	
X	0.642 BSC		16.31 BSC	
Y	0.342 BSC		8.69 BSC	

- STYLE 1:
1. PIN 1: RF INPUT/ CONT
 2. VS1
 3. VS2
 4. VS3
 5. VS4
 6. VS5
 7. RF OUTPUT
- CASE: GROUND

**CASE 301F-03
ISSUE C**

Motorola reserves the right to make changes without further notice to any products herein. Motorola makes no warranty, representation or guarantee regarding the suitability of its products for any particular purpose, nor does Motorola assume any liability arising out of the application or use of any product or circuit, and specifically disclaims any and all liability, including without limitation consequential or incidental damages. "Typical" parameters can and do vary in different applications. All operating parameters, including "Typicals" must be validated for each customer application by customer's technical experts. Motorola does not convey any license under its patent rights nor the rights of others. Motorola products are not designed, intended, or authorized for use as components in systems intended for surgical implant into the body, or other applications intended to support or sustain life, or for any other application in which the failure of the Motorola product could create a situation where personal injury or death may occur. Should Buyer purchase or use Motorola products for any such unintended or unauthorized application, Buyer shall indemnify and hold Motorola and its officers, employees, subsidiaries, affiliates, and distributors harmless against all claims, costs, damages, and expenses, and reasonable attorney fees arising out of, directly or indirectly, any claim of personal injury or death associated with such unintended or unauthorized use, even if such claim alleges that Motorola was negligent regarding the design or manufacture of the part. Motorola and  are registered trademarks of Motorola, Inc. Motorola, Inc. is an Equal Opportunity/Affirmative Action Employer.

Literature Distribution Centers:

USA: Motorola Literature Distribution; P.O. Box 20912; Phoenix, Arizona 85036.

EUROPE: Motorola Ltd.; European Literature Centre; 88 Tanners Drive, Blakelands, Milton Keynes, MK14 5BP, England.

JAPAN: Nippon Motorola Ltd.; 4-32-1, Nishi-Gotanda, Shinagawa-ku, Tokyo 141, Japan.

ASIA PACIFIC: Motorola Semiconductors H.K. Ltd.; Silicon Harbour Center, No. 2 Dai King Street, Tai Po Industrial Estate, Tai Po, N.T., Hong Kong.



MHW804/D