

The RF Line NPN Silicon High-Frequency Transistors

Designed for low noise, wide dynamic range front-end amplifiers and low-noise VCO's. Available in a surface-mountable plastic packages. This Motorola series of small-signal plastic transistors offers superior quality and performance at low cost.

- High Gain-Bandwidth Product
 $f_T = 8.0 \text{ GHz (Typ) @ 50 mA}$
- Low Noise Figure
 $NF_{\min} = 1.6 \text{ dB (Typ) @ } f = 1.0 \text{ GHz (MRF5711LT1, MRF571)}$
- High Gain
 $G_{NF} = 17 \text{ dB (Typ) @ } 30 \text{ mA/500 MHz (MMBR571LT1)}$
- High Power Gain
 $G_{pe} \text{ (matched)} = 13.5 \text{ dB (Typ) (MRF5711LT1)}$
- State-of-the-Art Technology
Fine Line Geometry
Ion-Implanted Arsenic Emitters
Gold Top Metallization and Wires
Silicon Nitride Passivation
- Available in tape and reel packaging options:
T1 suffix = 3,000 units per reel

MMBR571LT1
MRF571
MRF5711LT1

$I_C = 80 \text{ mA}$
LOW NOISE
HIGH-FREQUENCY
TRANSISTORS

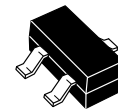

CASE 318-08, STYLE 6
SOT-23
LOW PROFILE
MMBR571LT1

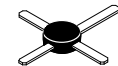

CASE 317-01, STYLE 2
MACRO-X
MRF571

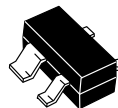

CASE 318A-05, STYLE 1
SOT-143
LOW PROFILE
MRF5711LT1

MAXIMUM RATINGS

Rating	Symbol	Value	Unit
Collector-Emitter Voltage	V_{CEO}	10	Vdc
Collector-Base Voltage	V_{CBO}	20	Vdc
Emitter-Base Voltage	V_{EBO}	3.0	Vdc
Collector Current — Continuous	I_C	80	mA
Total Device Dissipation @ $T_{\text{case}} = 75^\circ\text{C}$ MMBR571LT1, MRF5711LT1	$P_{D(\text{max})}$	0.33	W
Derate linearly above $T_{\text{case}} = 75^\circ\text{C}$ @		4.44	mW/°C
Total Device Dissipation (1) @ $T_C = 75^\circ\text{C}$ Derate above 75°C MRF571	P_D	0.58	Watts
		7.73	mW/°C
Operating and Storage Temperature	T_{stg}	-55 to +150	°C

THERMAL CHARACTERISTICS

Rating	Symbol	Max	Unit
Thermal Resistance, Junction to Case MRF5711LT1, MMBR571LT1	$R_{\theta JC}$	225	°C/W
Thermal Resistance, Junction to Case MRF571	$R_{\theta JC}$	130	°C/W
Maximum Junction Temperature	$T_{J\text{max}}$	150	°C

DEVICE MARKING

MMBR571LT1 = 7X MRF5711LT1 = 02

NOTE:

1. Case temperature measured on collector lead immediately adjacent to body of package.



ELECTRICAL CHARACTERISTICS ($T_A = 25^\circ\text{C}$ unless otherwise noted)

Characteristic	Symbol	Min	Typ	Max	Unit
OFF CHARACTERISTICS					
Collector–Emitter Breakdown Voltage ($I_C = 1.0\text{ mA}$, $I_B = 0$)	$V_{(BR)CEO}$	10	12	—	Vdc
Collector–Base Breakdown Voltage ($I_C = 0.1\text{ mA}$, $I_E = 0$)	$V_{(BR)CBO}$	20	—	—	Vdc
Emitter–Base Breakdown Voltage ($I_E = 50\text{ }\mu\text{Adc}$, $I_C = 0$)	$V_{(BR)EBO}$	2.5	—	—	Vdc
Collector Cutoff Current ($V_{CB} = 8.0\text{ Vdc}$, $I_E = 0$)	I_{CBO}	—	—	10	μAdc

ON CHARACTERISTICS

DC Current Gain ($I_C = 30\text{ mAdc}$, $V_{CE} = 5.0\text{ Vdc}$)	h_{FE}	50	—	300	—
--	----------	----	---	-----	---

DYNAMIC CHARACTERISTICS

Collector–Base Capacitance ($V_{CB} = 10\text{ Vdc}$, $I_E = 0$, $f = 1.0\text{ MHz}$) ($V_{CB} = 6.0\text{ Vdc}$, $I_E = 0$, $f = 1.0\text{ MHz}$)	MMBR571LT1 MRF5711LT1, MRF571	C_{cb}	— —	0.7 0.75	1.0 1.0	pF
Current Gain–Bandwidth Product ($V_{CE} = 5.0\text{ Vdc}$, $I_C = 50\text{ mAdc}$, $f = 1.0\text{ GHz}$) ($V_{CE} = 8.0\text{ Vdc}$, $I_C = 50\text{ mAdc}$, $f = 1.0\text{ GHz}$)	MMBR571LT1 MRF5711LT1, MRF571	f_T	— —	8.0 8.0	— —	GHz

FUNCTIONAL TESTS

Gain @ Noise Figure ($I_C = 10\text{ mAdc}$, $V_{CE} = 6.0\text{ Vdc}$)	MRF571 MRF571	$f = 0.5\text{ GHz}$ $f = 1.0\text{ GHz}$	G_{NF}	— 10	16.5 12	— —	dB
Noise Figure ($I_C = 10\text{ mAdc}$, $V_{CE} = 6.0\text{ Vdc}$)	MRF571 MRF571	$f = 0.5\text{ GHz}$ $f = 1.0\text{ GHz}$ $f = 2.0\text{ GHz}$	NF	— — —	1.0 1.5 2.8	— 2.0 —	dB
Gain @ Noise Figure ($I_C = 10\text{ mAdc}$, $V_{CE} = 5.0\text{ Vdc}$) ($I_C = 10\text{ mA}$, $V_{CE} = 6.0\text{ Vdc}$)	MMBR571LT1 MRF5711LT1	$f = 0.5\text{ GHz}$ $f = 1.0\text{ GHz}$ $f = 1.0\text{ GHz}$	G_{NF}	— — —	16.5 10.5 13.5	— — —	dB
Noise Figure ($I_C = 10\text{ mAdc}$, $V_{CE} = 5.0\text{ Vdc}$) ($I_C = 10\text{ mAdc}$, $V_{CE} = 6.0\text{ Vdc}$)	MMBR571LT1 MRF5711LT1	$f = 0.5\text{ GHz}$ $f = 1.0\text{ GHz}$ $f = 1.0\text{ GHz}$	NF	— — —	2.0 2.6 2.2	— — —	dB
Noise Figure ($V_{CE} = 6.0\text{ V}$, $I_C = 10\text{ mA}$, $f = 1.0\text{ GHz}$)	MRF5711LT1		NF_{min}	—	1.6	—	dB
Power Gain in 50 Ω System ($V_{CE} = 6.0\text{ V}$, $I_C = 10\text{ mA}$, $f = 1.0\text{ GHz}$)	MRF5711LT1		$ S_{21} ^2$	9.0	10	—	dB

TYPICAL CHARACTERISTICS
MMBR571LT1

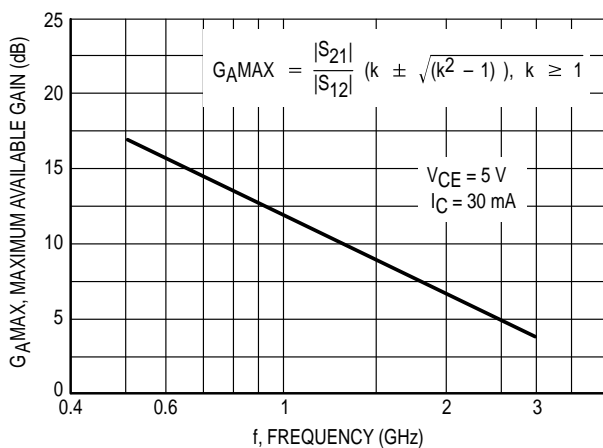

Figure 1. Maximum Available Gain versus Frequency

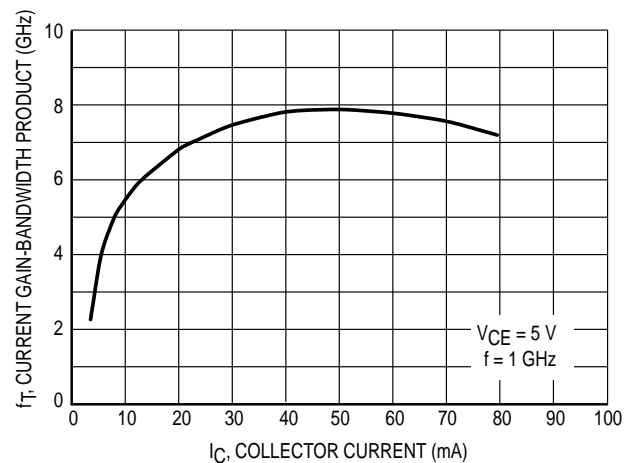

Figure 2. Current Gain–Bandwidth versus Collector Current @ 1.0 GHz

**TYPICAL CHARACTERISTICS
MMBR571LT1**

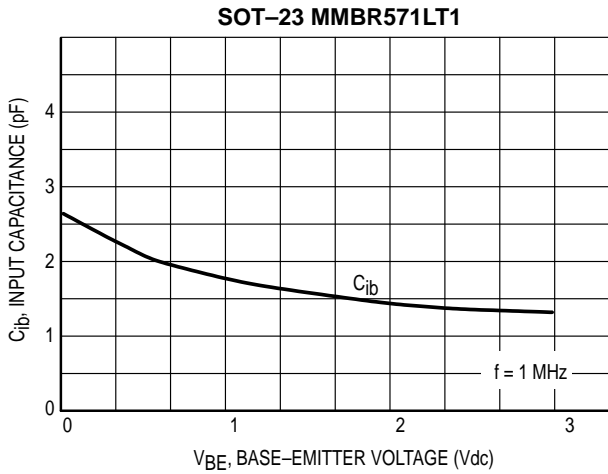

Figure 3. Input Capacitance versus Emitter Base Voltage

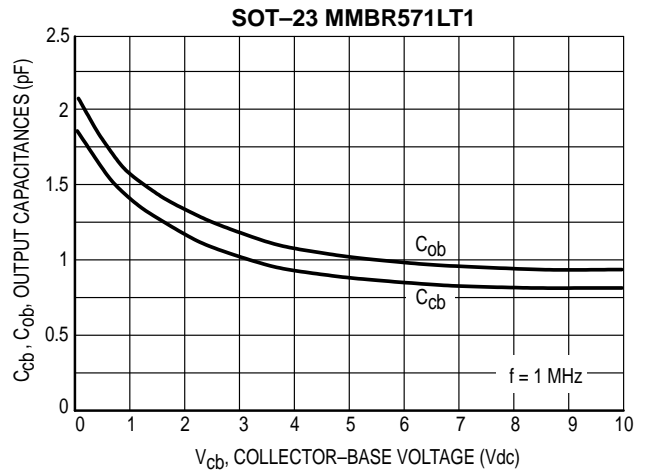

Figure 4. Output Capacitances versus Collector-Base Voltage

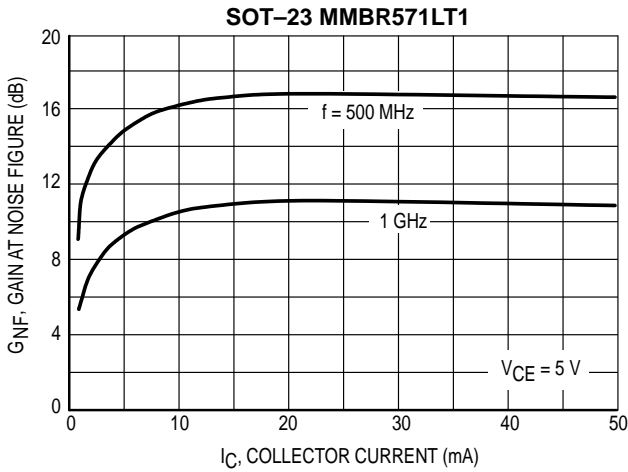

Figure 5. Gain at Noise Figure versus Collector Current

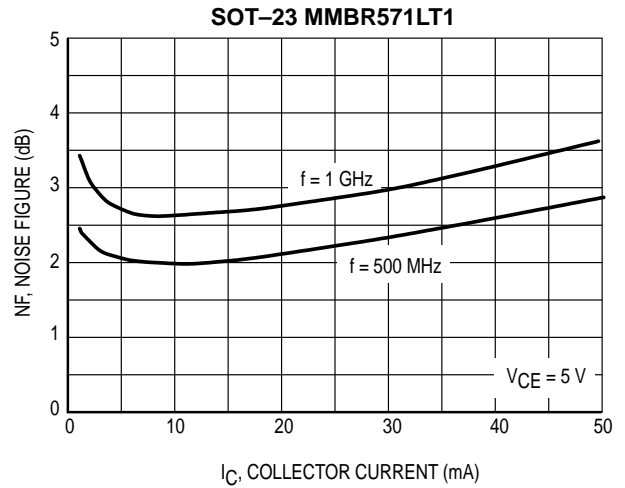

Figure 6. Noise Figure versus Collector Current

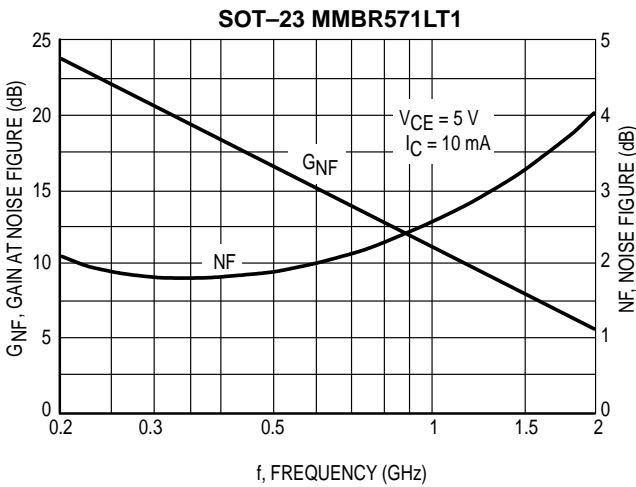

Figure 7. Gain at Noise Figure and Noise Figure versus Frequency

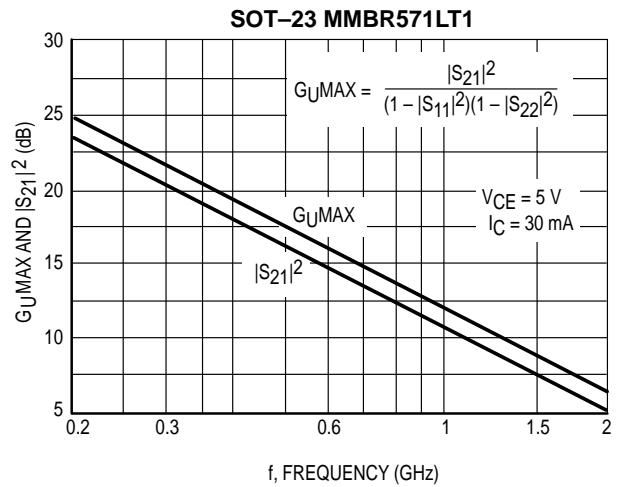

Figure 8. Maximum Unilateral Gain and Insertion Gain versus Frequency

TYPICAL CHARACTERISTICS
MRF5711LT1

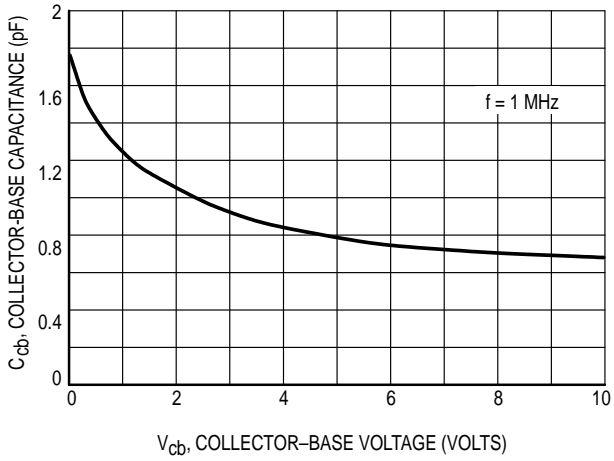

Figure 9. Collector-Base Capacitance versus Collector-Base Voltage

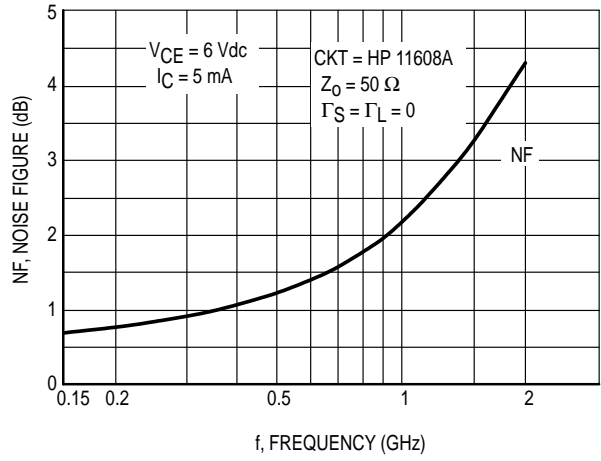

Figure 10. 50 Ω Noise Figure versus Frequency

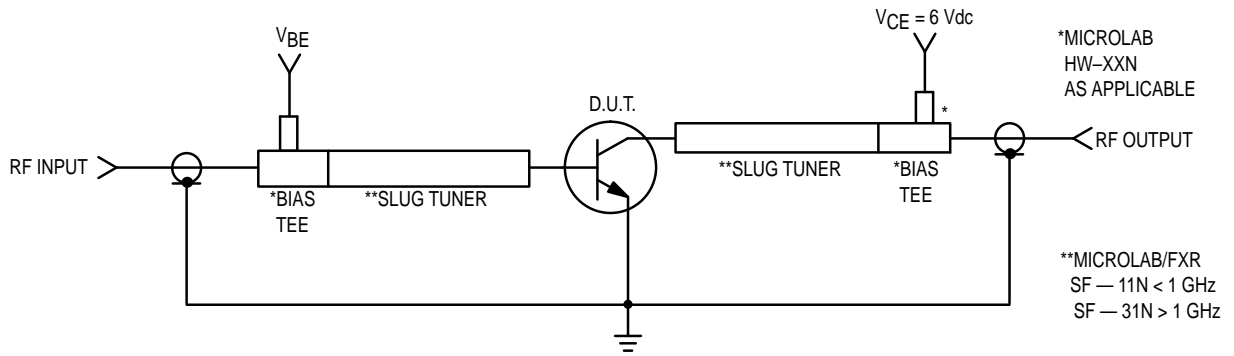

Figure 11. Functional Circuit Schematic

TYPICAL CHARACTERISTICS
MRF5711LT1

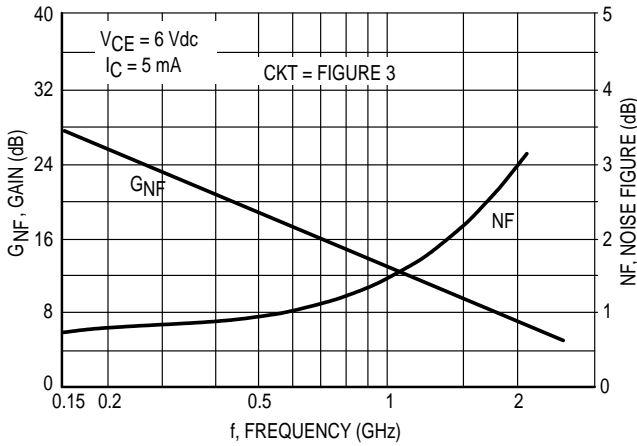

Figure 12. Gain and Noise Figure versus Frequency

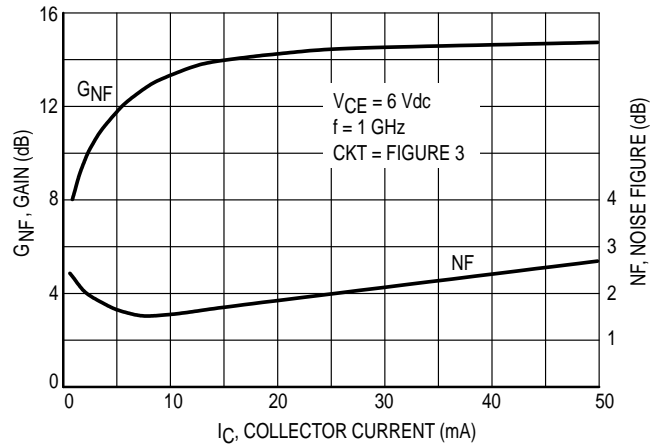

Figure 13. Gain and Noise Figure versus Collector Current

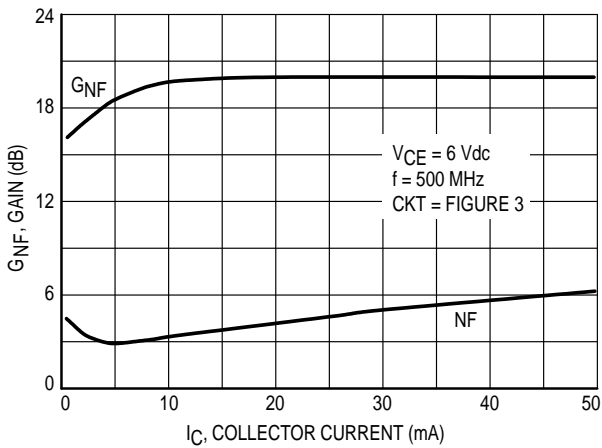

Figure 14. Gain and Noise Figure versus Collector Current

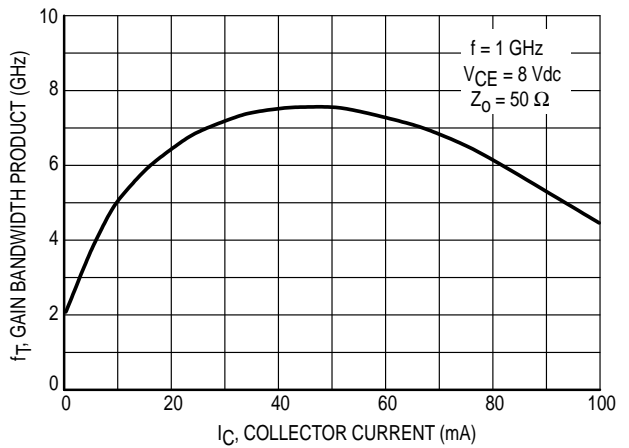

Figure 15. Gain Bandwidth Product versus Collector Current

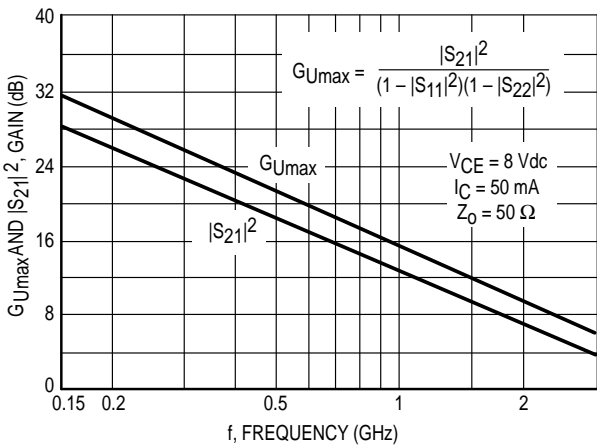

Figure 16. G_{Umax} and $|S_{21}|^2$ versus Frequency

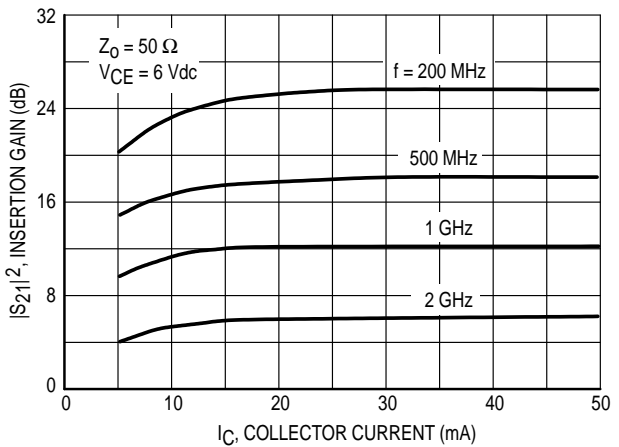

Figure 17. Insertion Gain versus Collector Current

MMBR571LT1

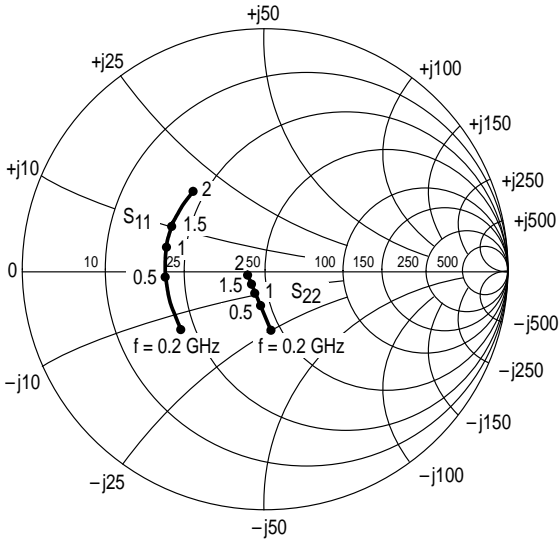

Figure 18. Input/Output Reflection Coefficients versus Frequency
 $V_{CE} = 5.0 \text{ V}$, $I_C = 30 \text{ mA}$

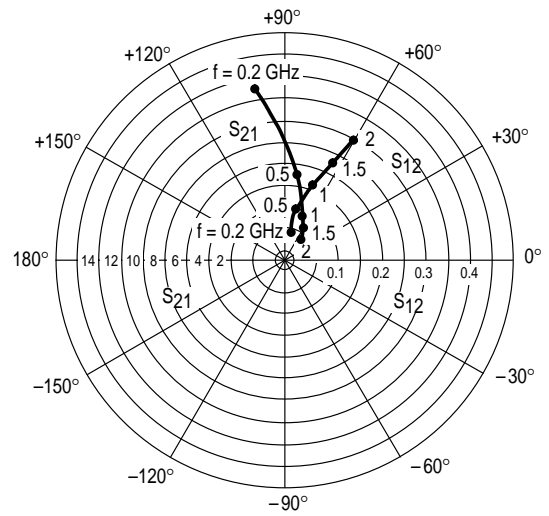
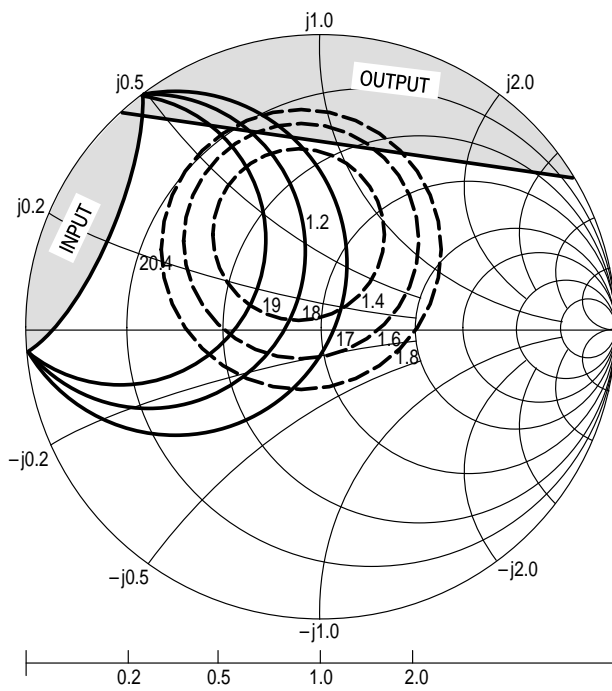

Figure 19. Forward/Reverse Transmission Coefficients versus Frequency
 $V_{CE} = 5.0 \text{ V}$, $I_C = 30 \text{ mA}$

VCE (Volts)	IC (mA)	f (MHz)	S11		S21		S12		S22	
			S11	$\angle \phi$	S21	$\angle \phi$	S12	$\angle \phi$	S22	$\angle \phi$
5.0	5.0	200	0.68	-82	8.41	126	0.07	53	0.61	-45
		500	0.52	-142	4.62	93	0.10	46	0.35	-60
		1000	0.50	179	2.57	72	0.14	53	0.26	-71
		1500	0.51	161	1.82	57	0.19	58	0.24	-77
		2000	0.52	143	1.48	45	0.24	59	0.22	-86
	15	200	0.46	-125	13.65	108	0.05	60	0.35	-73
		500	0.43	-169	6.03	86	0.09	66	0.17	-94
		1000	0.44	168	3.20	72	0.16	67	0.14	-111
		1500	0.45	152	2.21	58	0.22	64	0.11	-118
		2000	0.46	137	1.80	48	0.29	59	0.10	-131
	30	200	0.42	-148	14.79	102	0.04	68	0.26	-87
		500	0.41	-177	6.31	84	0.09	72	0.14	-115
		1000	0.42	165	3.35	71	0.16	70	0.12	-135
		1500	0.44	151	2.29	59	0.23	65	0.11	-144
		2000	0.44	135	1.84	48	0.30	60	0.10	-157
	50	200	0.41	-159	15.14	98	0.04	73	0.21	-96
		500	0.42	179	6.38	83	0.09	75	0.13	-124
		1000	0.43	163	3.35	70	0.16	71	0.12	-143
		1500	0.44	148	2.32	58	0.23	66	0.10	-151
		2000	0.45	134	1.84	48	0.30	60	0.09	-163

Table 1. MMBR571LT1 Common Emitter S-Parameters



$V_{CE} = 5\text{ V}$
 $I_C = 10\text{ mA}$
 □ = Area of Instability

f (GHz)	NF OPT	Γ_{MS} NF OPT	R_n	K
0.5	1.20 dB	$0.36 \angle 104^\circ$	7	0.63

Figure 20. MRF5711LT1 Constant Gain and Noise Figure Contours (f = 0.5 GHz)

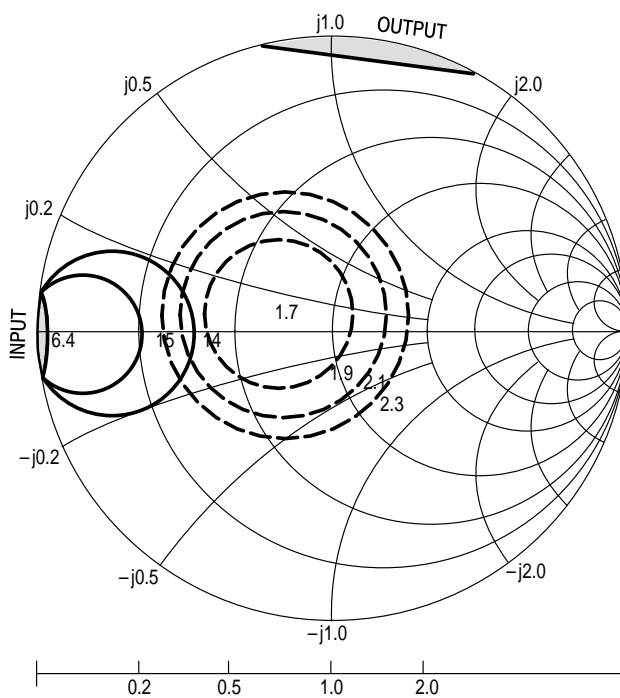

$V_{CE} = 5\text{ V}$
 $I_C = 10\text{ mA}$
 □ = Area of Instability

f (GHz)	NF OPT	Γ_{MS} NF OPT	R_n	K
1.0	1.70 dB	$0.20 \angle 162^\circ$	8	0.94

Figure 21. MRF5711LT1 Constant Gain and noise Figure Contours (f = 1.0 GHz)

VCE (Vdc)	IC (mA)	f (MHz)	S11		S21		S12		S22	
			S11	∠φ	S21	∠φ	S12	∠φ	S22	∠φ
6.0	5.0	200	0.79	-90	10.9	128	0.06	46	0.70	-45
		500	0.72	-144	5.7	96	0.08	28	0.42	-66
		1000	0.69	-177	3.0	75	0.09	28	0.31	-77
		1500	0.66	164	2.0	59	0.10	32	0.34	-89
		2000	0.65	147	1.6	47	0.12	38	0.32	-94
	10	200	0.72	-115	15.2	118	0.05	41	0.55	-66
		500	0.69	-160	6.9	92	0.06	34	0.30	-92
		1000	0.67	174	3.6	74	0.08	42	0.21	-108
		1500	0.64	159	2.4	60	0.10	46	0.23	-114
		2000	0.64	143	1.8	49	0.12	50	0.20	-116
	50	200	0.67	-159	20	102	0.02	48	0.33	-111
		500	0.67	179	8.2	85	0.04	58	0.33	-142
		1000	0.66	174	3.8	72	0.07	65	0.21	-158
		1500	0.63	151	2.7	61	0.10	64	0.22	-158
		2000	0.58	138	2.1	51	0.14	62	0.17	-165
8.0	5.0	200	0.80	-87	11.1	130	0.06	47	0.71	-42
		500	0.72	-141	5.9	97	0.08	30	0.44	-60
		1000	0.70	-177	3.1	75	0.09	28	0.33	-68
		1500	0.66	166	2.1	60	0.10	32	0.35	-80
		2000	0.61	149	1.6	47	0.12	39	0.35	-85
	10	200	0.72	-113	15.6	119	0.05	42	0.56	-61
		500	0.68	-159	7.2	92	0.06	34	0.31	-82
		1000	0.66	175	3.7	74	0.08	41	0.21	-92
		1500	0.64	160	2.5	61	0.09	47	0.23	-101
		2000	0.60	144	2.0	49	0.13	50	0.21	-103
	50	200	0.66	-156	20.9	103	0.02	48	0.31	-101
		500	0.65	-179	8.6	85	0.04	58	0.19	-128
		1000	0.64	164	4.3	72	0.07	65	0.16	-144
		1500	0.61	153	2.9	61	0.10	65	0.17	-142
		2000	0.58	137	2.3	51	0.13	64	0.14	-145

Table 2. MRF5711LT1 Common Emitter S-Parameters

TYPICAL CHARACTERISTICS
MRF571

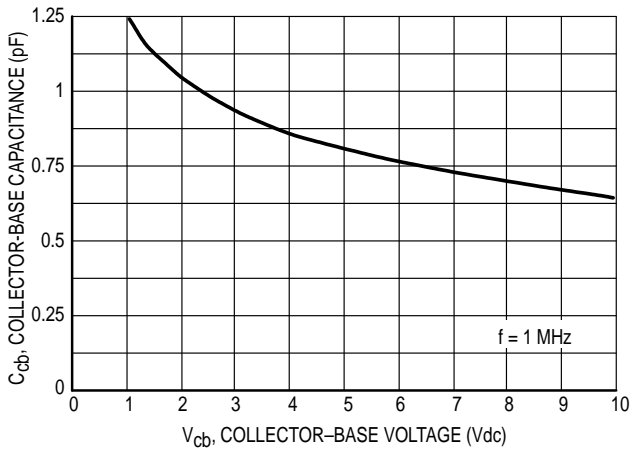

Figure 22. C_{cb} , Collector-Base Capacitance versus Voltage

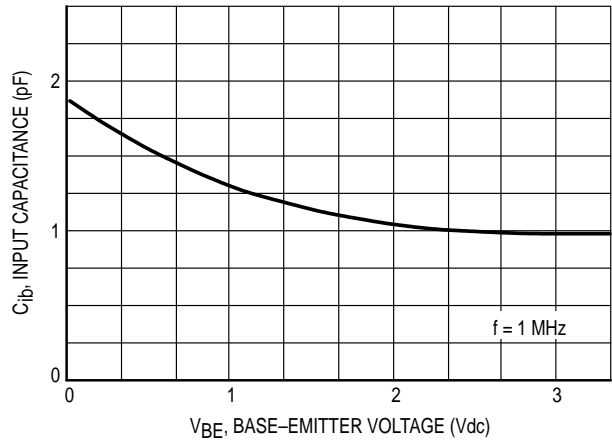

Figure 23. C_{ib} , Input Capacitance versus Emitter Base Voltage

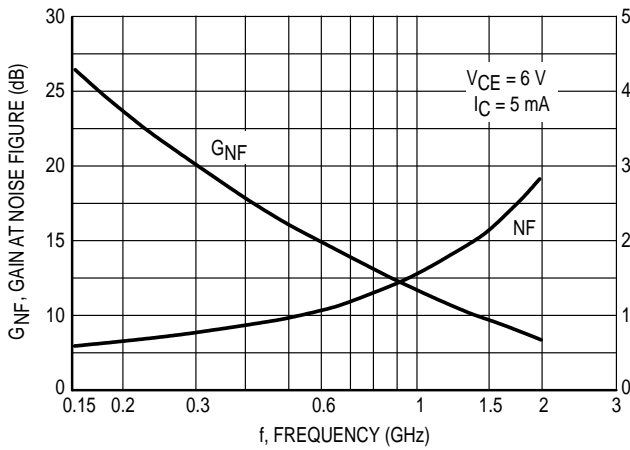

Figure 24. Gain at Noise Figure and Noise Figure versus Frequency

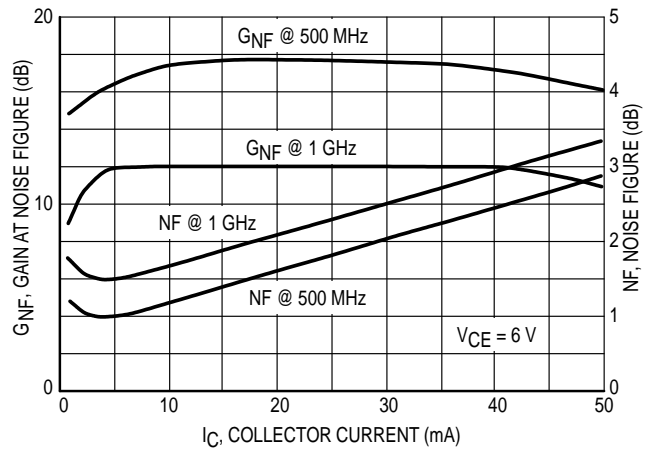

Figure 25. Gain at Noise Figure and Noise Figure versus Collector Current

**TYPICAL CHARACTERISTICS
MRF571**

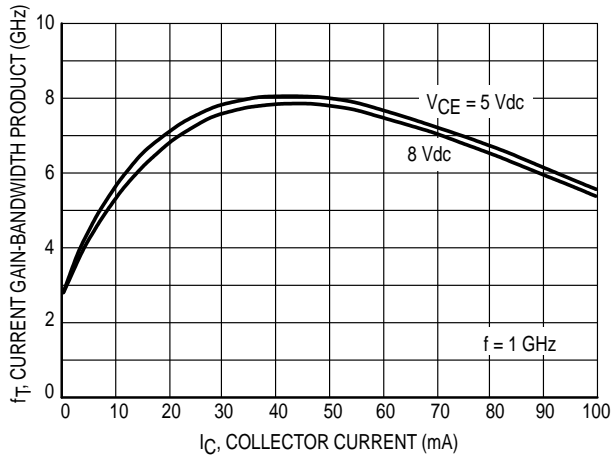

Figure 26. f_T , Current Gain–Bandwidth Product versus Collector Current

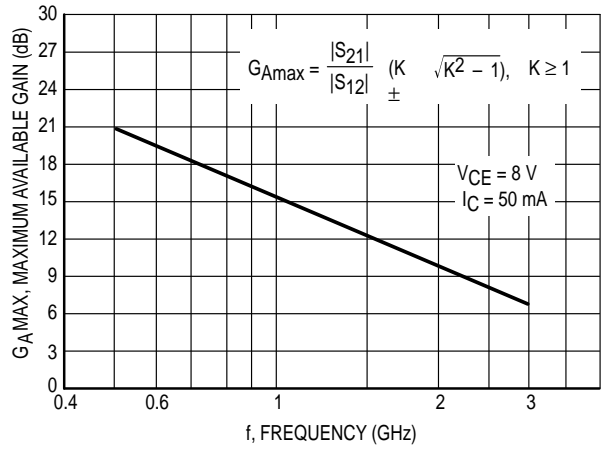

Figure 27. G_{Amax} , Maximum Available Gain versus Frequency

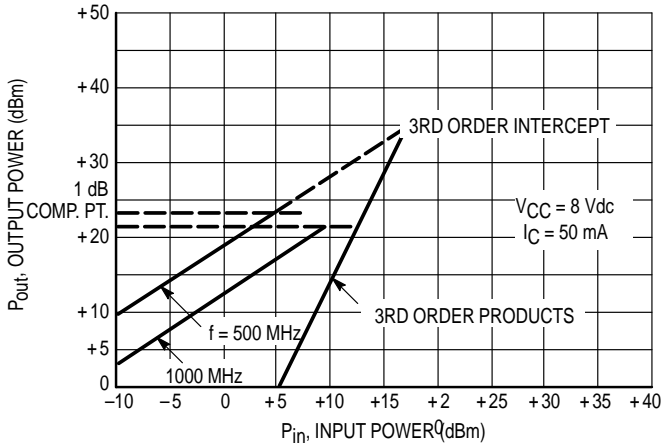

Figure 28. 1.0 dB Compression Point and Third Order Intercept

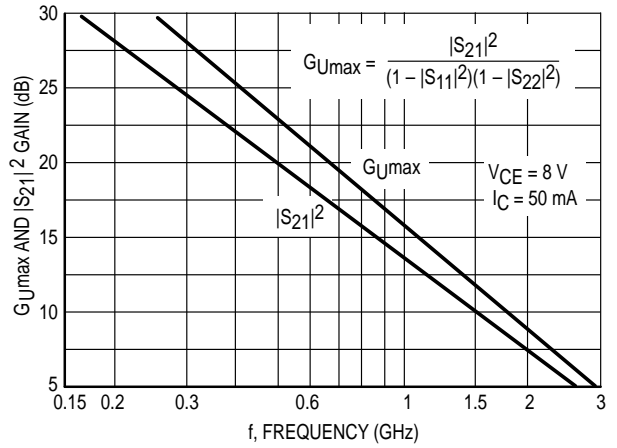

Figure 29. G_{Umax} and $|S_{21}|^2$ versus Frequency

MRF571

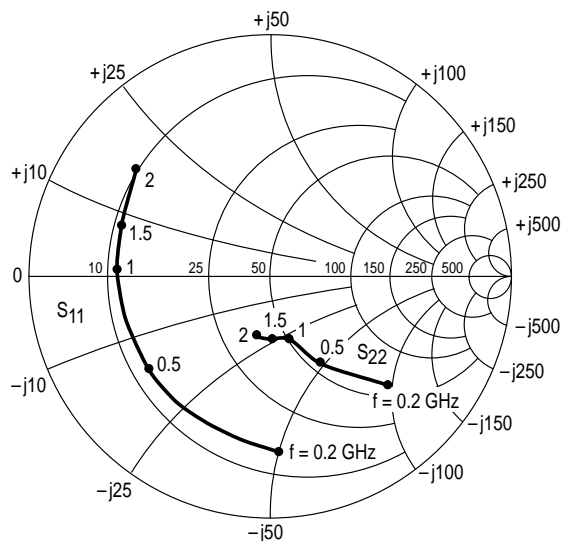

Figure 30. Input/Output Reflection Coefficients versus Frequency (GHz)
VCE = 6.0 V, IC = 5.0 mA

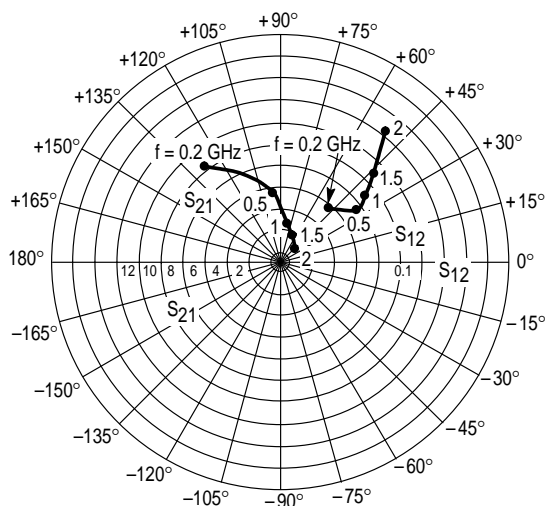
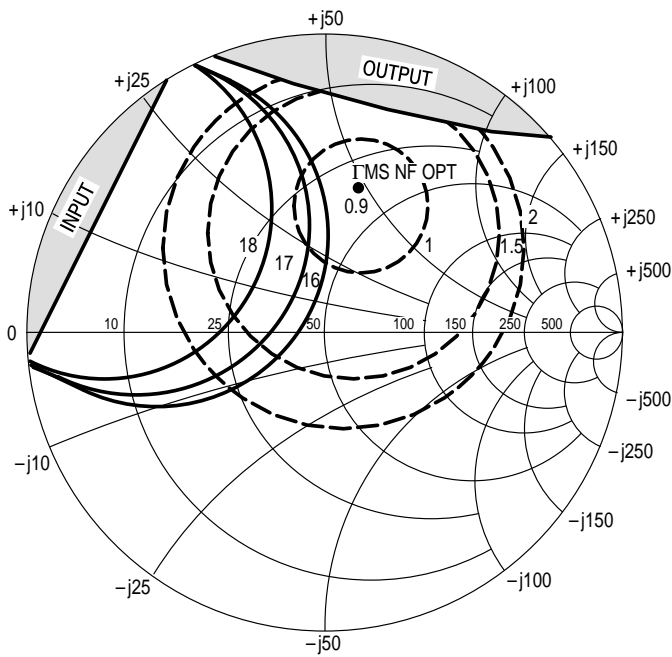

Figure 31. Forward/Reverse Transmission Coefficients versus Frequency (GHz)
VCE = 6.0 V, IC = 5.0 mA

VCE (Volts)	IC (mA)	f (MHz)	S11		S21		S12		S22	
			S11	∠ φ	S21	∠ φ	S12	∠ φ	S22	∠ φ
6.0	5	200	0.74	-86	10.5	129	0.06	48	0.69	-42
		500	0.62	-143	5.5	97	0.08	33	0.41	-59
		1000	0.61	178	3.0	78	0.09	37	0.28	-69
		1500	0.65	158	2.0	62	0.11	44	0.26	-88
		2000	0.70	140	1.6	51	0.14	51	0.27	-99
	10	200	0.64	-111	15	118	0.04	44	0.53	-59
		500	0.58	-160	6.9	93	0.06	42	0.27	-77
		1000	0.59	168	3.7	77	0.09	52	0.16	-91
		1500	0.63	151	2.5	64	0.12	56	0.16	-113
		2000	0.67	134	2.0	53	0.16	57	0.16	-118
	50	200	0.56	-160	20.4	102	0.02	57	0.27	-98
		500	0.57	176	8.4	86	0.05	67	0.14	-130
		1000	0.60	156	4.4	75	0.09	70	0.11	-164
		1500	0.62	152	2.9	64	0.13	68	0.13	-175
		2000	0.66	127	2.4	53	0.18	62	0.11	-178
8.0	5	200	0.75	-83	10.7	129	0.06	49	0.71	-39
		500	0.62	-140	5.1	98	0.08	34	0.43	-54
		1000	0.60	-179	3.7	78	0.09	38	0.31	-62
		1500	0.64	159	2.1	62	0.10	45	0.29	-80
		2000	0.69	141	1.7	52	0.13	52	0.29	-91
	10	200	0.64	-99	15.1	120	0.05	46	0.54	-60
		500	0.52	-152	7.1	94	0.07	45	0.32	-75
		1000	0.52	170	3.7	76	0.10	54	0.15	-82
		1500	0.52	150	2.5	62	0.13	56	0.16	-108
		2000	0.57	133	2.0	51	0.18	55	0.16	-107
	50	200	0.52	-153	19.6	102	0.03	56	0.28	-92
		500	0.52	178	8.1	86	0.05	67	0.16	-98
		1000	0.56	157	4.1	73	0.10	70	0.06	-130
		1500	0.54	139	2.8	62	0.13	68	0.11	-146
		2000	0.59	126	2.2	52	0.19	63	0.10	-137

Table 3. MRF571 Common Emitter S-Parameters



$V_{CE} = 6.0 \text{ V}$, $I_C = 5.0 \text{ mA}$
 $f = 500 \text{ MHz}$
 [Shaded Area] — REGION OF INSTABILITY

f (GHz)	NF OPT (dB)	Rn (Ω)	NF50 Ω (dB)
0.5	0.9	9.3	1.3

$\Gamma_{MS} \text{ NF OPT}$	K
$0.49 \angle 74^\circ$	0.58

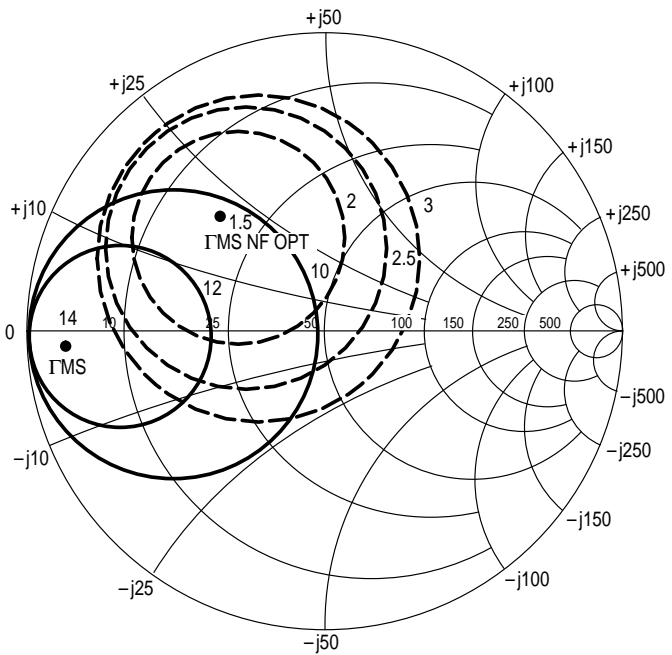

$V_{CE} = 6.0 \text{ V}$, $I_C = 5.0 \text{ mA}$
 $f = 1.0 \text{ GHz}$

f (GHz)	NF OPT (dB)	Rn (Ω)	NF50 Ω (dB)	$\Gamma_{MS} \text{ NF OPT}$
1.0	1.5	7.5	2.2	$0.48 \angle 134^\circ$

Γ_{MS}	Γ_{ML}
$0.89 \angle -179^\circ$	$0.81 \angle 66^\circ$

Figure 32. MRF571 Constant Gain and Noise Figure Contours

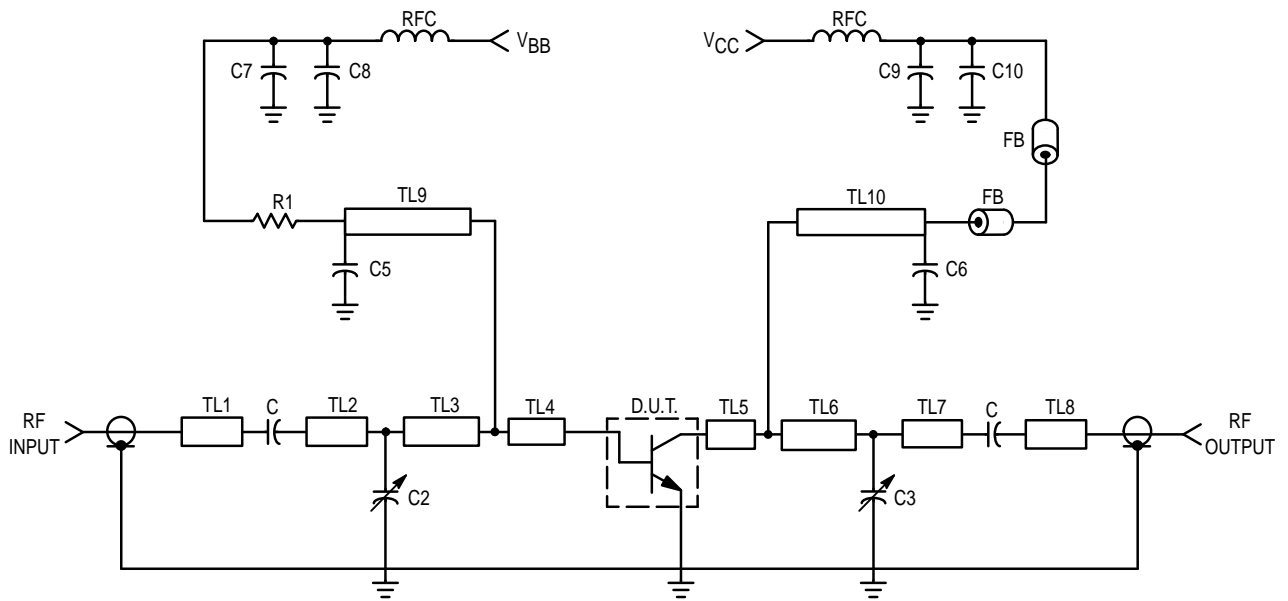

- | | |
|--|--|
| C1, C4, C5, C6, C8, C9 — 100 pF Chip Capacitor | TL1, TL7, TL8 — Microstrip 0.162" x 0.600" |
| C2, C3 — 0.8–8.0 pF Johanson Capacitor | TL2 — Microstrip 0.162" x 1.060" |
| C7, C10 — 10 μ F Tantalum Capacitor | TL3 — Microstrip 0.162" x 0.700" |
| R1 — 1.0 kOhms Res. | TL4, TL5 — Microstrip 0.162" x 0.440" |
| RFC — VK-200, Ferroxcube | TL6 — Microstrip 0.162" x 1.140" |
| FB — Ferrite Bead, Ferroxcube 56-590-65/3B | TL8, TL9 — Microstrip 0.020" x 2.130" |
| Board Material — 0.0625" Glass Teflon, $\epsilon_r = 2.55$ | |

Figure 33. MRF571 Test Circuit Schematic

PACKAGE DIMENSIONS

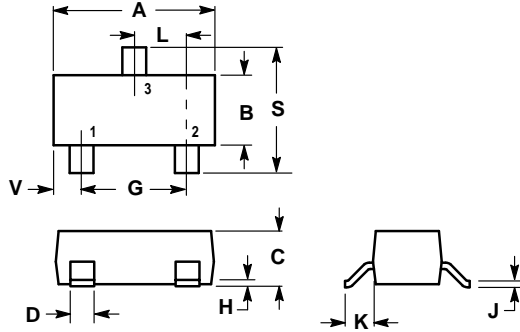

NOTES:

1. DIMENSIONING AND TOLERANCING PER ANSI Y14.5M, 1982.
2. CONTROLLING DIMENSION: INCH.
3. MAXIMUM LEAD THICKNESS INCLUDES LEAD FINISH THICKNESS. MINIMUM LEAD THICKNESS IS THE MINIMUM THICKNESS OF BASE MATERIAL.

DIM	INCHES		MILLIMETERS	
	MIN	MAX	MIN	MAX
A	0.1102	0.1197	2.80	3.04
B	0.0472	0.0551	1.20	1.40
C	0.0350	0.0440	0.89	1.11
D	0.0150	0.0200	0.37	0.50
G	0.0701	0.0807	1.78	2.04
H	0.0005	0.0040	0.013	0.100
J	0.0034	0.0070	0.085	0.177
K	0.0140	0.0285	0.35	0.69
L	0.0350	0.0401	0.89	1.02
S	0.0830	0.1039	2.10	2.64
V	0.0177	0.0236	0.45	0.60

STYLE 6:

- PIN 1. BASE
2. EMITTER
3. COLLECTOR

**CASE 318-08
ISSUE AF
MMBR571LT1**

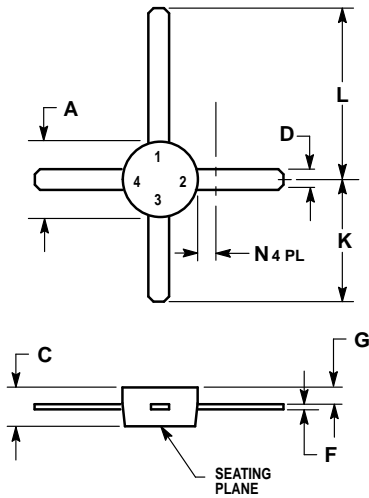

NOTES:

1. DIMENSION D NOT APPLICABLE IN ZONE N.

DIM	MILLIMETERS		INCHES	
	MIN	MAX	MIN	MAX
A	4.44	5.21	0.175	0.205
C	1.90	2.54	0.075	0.100
D	0.84	0.99	0.033	0.039
F	0.20	0.30	0.080	0.012
G	0.76	1.14	0.030	0.045
K	7.24	8.13	0.285	0.320
L	10.54	11.43	0.415	0.450
N	—	1.65	—	0.065

STYLE 2:

- PIN 1. COLLECTOR
2. EMITTER
3. BASE
4. EMITTER

**CASE 317-01
ISSUE E
MRF571**

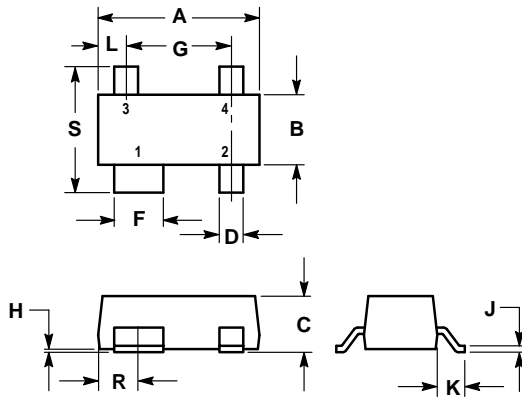

- NOTES:
 4. DIMENSIONING AND TOLERANCING PER ANSI Y14.5M, 1982.
 5. CONTROLLING DIMENSION: MILLIMETER.

DIM	MILLIMETERS		INCHES	
	MIN	MAX	MIN	MAX
A	2.80	3.04	0.110	0.120
B	1.20	1.39	0.047	0.055
C	0.84	1.14	0.033	0.045
D	0.39	0.50	0.015	0.020
F	0.79	0.93	0.031	0.037
G	1.78	2.03	0.070	0.080
H	0.013	0.10	0.0005	0.004
J	0.08	0.15	0.003	0.006
K	0.46	0.60	0.018	0.024
L	0.445	0.60	0.0175	0.024
R	0.72	0.83	0.028	0.033
S	2.11	2.48	0.083	0.098

- STYLE 1:
 PIN 1. COLLECTOR
 2. EMITTER
 3. EMITTER
 4. BASE

**CASE 318A-05
 ISSUE R
 MRF5711LT1**

Motorola reserves the right to make changes without further notice to any products herein. Motorola makes no warranty, representation or guarantee regarding the suitability of its products for any particular purpose, nor does Motorola assume any liability arising out of the application or use of any product or circuit, and specifically disclaims any and all liability, including without limitation consequential or incidental damages. "Typical" parameters which may be provided in Motorola data sheets and/or specifications can and do vary in different applications and actual performance may vary over time. All operating parameters, including "Typicals" must be validated for each customer application by customer's technical experts. Motorola does not convey any license under its patent rights nor the rights of others. Motorola products are not designed, intended, or authorized for use as components in systems intended for surgical implant into the body, or other applications intended to support or sustain life, or for any other application in which the failure of the Motorola product could create a situation where personal injury or death may occur. Should Buyer purchase or use Motorola products for any such unintended or unauthorized application, Buyer shall indemnify and hold Motorola and its officers, employees, subsidiaries, affiliates, and distributors harmless against all claims, costs, damages, and expenses, and reasonable attorney fees arising out of, directly or indirectly, any claim of personal injury or death associated with such unintended or unauthorized use, even if such claim alleges that Motorola was negligent regarding the design or manufacture of the part. Motorola and  are registered trademarks of Motorola, Inc. Motorola, Inc. is an Equal Opportunity/Affirmative Action Employer.

Mfax is a trademark of Motorola, Inc.

How to reach us:

USA/EUROPE/Locations Not Listed: Motorola Literature Distribution;
P.O. Box 5405, Denver, Colorado 80217. 303-675-2140 or 1-800-441-2447

JAPAN: Nippon Motorola Ltd.: SPD, Strategic Planning Office, 4-32-1,
Nishi-Gotanda, Shinagawa-ku, Tokyo 141, Japan. 81-3-5487-8488

Mfax™: RMFAX0@email.sps.mot.com – TOUCHTONE 602-244-6609
– US & Canada ONLY 1-800-774-1848

ASIA/PACIFIC: Motorola Semiconductors H.K. Ltd.; 8B Tai Ping Industrial Park,
51 Ting Kok Road, Tai Po, N.T., Hong Kong. 852-26629298

INTERNET: <http://motorola.com/sps>



MMBR571LT1/D