



Advance Information

# Low Voltage Rail-To-Rail™ SLEEPMODE™ Operational Amplifier

The MC33304 is a monolithic bipolar operational amplifier. This low voltage rail-to-rail amplifier has both a rail-to-rail input and output stage, with high output current capability. This amplifier also employs SLEEPMODE technology. In sleepmode, the micropower amplifier is active and waiting for an input signal. When a signal is applied, causing the amplifier to source or sink  $\geq 200 \mu\text{A}$  (typically) to the load, it will automatically switch to the awakemode (supplying up to 70 mA to the load). When the output current drops below  $90 \mu\text{A}$ , the amplifier automatically returns to the sleepmode.

Excellent performance can be achieved as an audio amplifier. This is due to the amplifier's low noise and low distortion. A delay circuit is incorporated to prevent crossover distortion.

- Ideal for Battery Applications
- Full Output Signal (No Distortion) for Battery Applications Down to  $\pm 0.9 \text{ VDC}$ .
- Single Supply Operation (+1.8 to +12 V)
- Rail-To-Rail Performance on Both the Input and Output
- Output Voltages Swings Typically within 100 mV of Both Rails ( $R_L = 1.0 \text{ m}\Omega$ )
- Two States: "Sleepmode" (Micropower,  $I_D = 110 \mu\text{A}/\text{Amp}$ ) and "Awakemode" (High Performance,  $I_D = 1200 \mu\text{A}/\text{Amp}$ )
- Automatic Return to Sleepmode when Output Current Drops Below Threshold, Allowing a Fully Functional Micropower Amplifier
- Independent Sleepmode Function for Each Amplifier
- No Phase Reversal on the Output for Overdriven Input Signals
- High Output Current (70 mA typically)
- 600  $\Omega$  Drive Capability
- Standard Pinouts; No Additional Pins or Components Required
- Drop-In Replacement for Many Other Quad Operational Amplifiers
- Similar to MC33201, MC33202 and MC33204 Family
- The MC33304 Amplifier is Offered in the Plastic DIP or SOIC Package (P and D Suffixes)

SLEEPMODE and Rail-To-Rail are trademarks of Motorola, Inc.

**TYPICAL DC ELECTRICAL CHARACTERISTICS** ( $T_A = 25^\circ\text{C}$ )

Characteristic	$V_{CC} = 2.0 \text{ V}$	$V_{CC} = 3.3 \text{ V}$	$V_{CC} = 5.0 \text{ V}$	Unit
Input Offset Voltage $V_{IO(\text{max})}$ MC33304	$\pm 10$	$\pm 10$	$\pm 10$	mV
Output Voltage Swing $V_{OH}$ ( $R_L = 600 \Omega$ ) $V_{OL}$ ( $R_L = 600 \Omega$ )	1.85 0.15	3.10 0.15	4.75 0.15	$V_{\text{min}}$ $V_{\text{max}}$
Power Supply Current per Amplifier ( $I_D$ ) Awakemode Sleepmode	1.625 140	1.625 140	1.625 140	mA $\mu\text{A}$

Specifications are for reference only and not necessarily guaranteed.  $V_{EE} = \text{Gnd}$ .

This document contains information on a new product. Specifications and information herein are subject to change without notice.

## MC33304

### RAIL-TO-RAIL SLEEPMODE OPERATIONAL AMPLIFIER

#### SEMICONDUCTOR TECHNICAL DATA

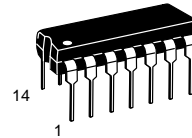

**P SUFFIX**  
PLASTIC PACKAGE  
CASE 646

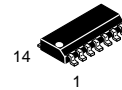

**D SUFFIX**  
PLASTIC PACKAGE  
CASE 751A  
(SO-14)

#### PIN CONNECTIONS

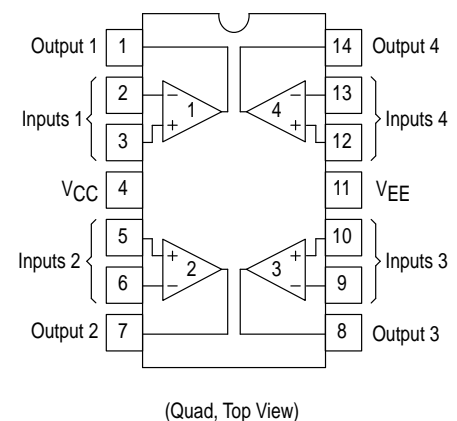

#### ORDERING INFORMATION

Device	Tested Operating Temperature Range	Package
MC33304D	$T_A = -40^\circ$ to $+105^\circ\text{C}$	SO-14
MC33304P		Plastic DIP

# MC33304

## MAXIMUM RATINGS

Rating	Symbol	Value	Unit
Supply Voltage ( $V_{CC}$ to $V_{EE}$ )	$V_S$	+16	V
ESD Protection Voltage at Any Pin Human Body Model	$V_{ESD}$	2000	V
Voltage at Any Device Pin (Note 2)	$V_{DP}$	$V_S \pm 0.5$	V
Input Differential Voltage Range	$V_{IDR}$	(Notes 1 & 2)	V
Output Short Circuit Duration	$t_s$	Indefinite (Note 3)	sec
Maximum Junction Temperature	$T_J$	+150	°C
Storage Temperature Range	$T_{stg}$	-65 to +150	°C
Maximum Power Dissipation	$P_D$	(Note 5)	mW

## RECOMMENDED OPERATING CONDITIONS

Characteristic	Symbol	Min	Typ	Max	Unit
Supply Voltage Single Supply Split Supplies	$V_S$	1.8 $\pm 0.9$	- -	12 $\pm 6.0$	V
Input Voltage Range, Sleepmode and Awakemode	$V_{ICR}$	$V_{EE}$	-	$V_{CC}$	V
Ambient Operating Temperature Range	$T_A$	-40	-	+105	°C

## DC ELECTRICAL CHARACTERISTICS ( $V_{CC} = +5.0$ V, $V_{EE} = \text{Gnd}$ , $T_A = 25^\circ\text{C}$ , unless otherwise noted.)

Characteristic	Symbol	Min	Typ	Max	Unit
Input Offset Voltage ( $V_{CM} = 0$ V, $V_O = 0$ V) (Note 4) Sleepmode and Awakemode $T_A = 25^\circ\text{C}$ $T_A = -40^\circ$ to $+105^\circ\text{C}$	$V_{IO}$	-10 -13	0.7 -	+10 +13	mV
Average Temperature Coefficient of Input Offset Voltage ( $R_S = 50 \Omega$ , $V_{CM} = 0$ V, $V_O = 0$ V) $T_A = -40^\circ$ to $+105^\circ\text{C}$ , Sleepmode and Awakemode	$\Delta V_{IO}/\Delta T$	-	2.0	-	$\mu\text{V}/^\circ\text{C}$
Input Bias Current ( $V_{CM} = 0$ V, $V_O = 0$ V) (Note 4) Awakemode $T_A = 25^\circ\text{C}$ $T_A = -40^\circ$ to $+105^\circ\text{C}$	$ I_{IB} $	- -	90 -	+200 +500	nA
Input Offset Current ( $V_{CM} = 0$ V, $V_O = 0$ V) (Note 4) Awakemode $T_A = 25^\circ\text{C}$ $T_A = -40^\circ$ to $+105^\circ\text{C}$	$ I_{IO} $	- -	3.1 -	+50 +100	nA
Large Signal Voltage Gain ( $V_{CC} = +5.0$ V, $V_{EE} = -5.0$ V) Awakemode, $R_L = 600 \Omega$ $T_A = 25^\circ\text{C}$ $T_A = -40^\circ$ to $+105^\circ\text{C}$	$A_{VOL}$	90 85	116 -	- -	dB
Power Supply Rejection Ratio, Awakemode	PSRR	65	90	-	dB
Output Short Circuit Current (Awakemode) ( $V_{ID} = \pm 0.2$ V) Source Sink	$I_{SC}$	-200 +50	-89 +89	-50 +200	mA
Output Transition Current, Source/Sink Sleepmode to Awakemode, $V_{CC} = +1.0$ V, $V_{EE} = -1.0$ V Awakemode to Sleepmode, $V_{CC} = +5.0$ V, $V_{EE} = -5.0$ V	$ I_{TH1} $ $ I_{TH2} $	- 90	- -	200 -	$\mu\text{A}$

# MC33304

## DC ELECTRICAL CHARACTERISTICS (continued) ( $V_{CC} = +5.0\text{ V}$ , $V_{EE} = \text{Gnd}$ , $T_A = 25^\circ\text{C}$ , unless otherwise noted.)

Characteristic	Symbol	Min	Typ	Max	Unit
Output Voltage Swing ( $V_{ID} = \pm 0.2\text{ V}$ )					V
Sleepmode					
$V_{CC} = +5.0\text{ V}$ , $V_{EE} = 0\text{ V}$ , $R_L = 1.0\text{ M}\Omega$	$V_{OH}$	4.90	4.97	–	
$V_{CC} = 0\text{ V}$ , $V_{EE} = -5.0\text{ V}$ , $R_L = 1.0\text{ M}\Omega$	$V_{OL}$	–	-4.96	-4.90	
$V_{CC} = +2.0\text{ V}$ , $V_{EE} = 0\text{ V}$ , $R_L = 1.0\text{ M}\Omega$	$V_{OH}$	1.90	1.98	–	
$V_{CC} = 0\text{ V}$ , $V_{EE} = -2.0\text{ V}$ , $R_L = 1.0\text{ M}\Omega$	$V_{OL}$	–	-1.97	-1.90	
Awakemode					
$V_{CC} = +5.0\text{ V}$ , $V_{EE} = 0\text{ V}$ , $R_L = 600\ \Omega$	$V_{OH}$	4.75	4.86	–	
$V_{CC} = 0\text{ V}$ , $V_{EE} = -5.0\text{ V}$ , $R_L = 600\ \Omega$	$V_{OL}$	–	-4.85	-4.75	
$V_{CC} = +2.0\text{ V}$ , $V_{EE} = 0\text{ V}$ , $R_L = 600\ \Omega$	$V_{OH}$	1.85	1.91	–	
$V_{CC} = 0\text{ V}$ , $V_{EE} = -2.0\text{ V}$ , $R_L = 600\ \Omega$	$V_{OL}$	–	-1.90	-1.85	
$V_{CC} = +2.5\text{ V}$ , $V_{EE} = -2.5\text{ V}$ , $R_L = 600\ \Omega$	$V_{OH}$	–	2.41	–	
$V_{CC} = +2.5\text{ V}$ , $V_{EE} = -2.5\text{ V}$ , $R_L = 600\ \Omega$	$V_{OL}$	–	-2.40	–	
Common Mode Rejection Ratio	CMRR	60	90	–	dB
Power Supply Current (per Amplifier)	$I_D$				$\mu\text{A}$
Sleepmode					
$V_{CC} = +2.0\text{ V}$ , $V_{EE} = 0\text{ V}$ $T_A = +25^\circ\text{C}$		–	85	–	
$V_{CC} = +2.5\text{ V}$ , $V_{EE} = -2.5\text{ V}$ $T_A = +25^\circ\text{C}$		–	110	140	
$T_A = -40^\circ\text{ to }+105^\circ\text{C}$		–	–	150	
$V_{CC} = +12\text{ V}$ , $V_{EE} = 0\text{ V}$ $T_A = +25^\circ\text{C}$		–	125	–	
Awakemode					
$V_{CC} = +2.5\text{ V}$ , $V_{EE} = -2.5\text{ V}$ $T_A = +25^\circ\text{C}$		–	1200	1625	
$T_A = -40^\circ\text{ to }+105^\circ\text{C}$		–	–	1750	
Thermal Resistance	$\theta_{JA}$				$^\circ\text{C/W}$
SOIC		–	145	–	
Plastic DIP		–	75	–	

## AC ELECTRICAL CHARACTERISTICS ( $V_{CC} = +6.0\text{ V}$ , $V_{EE} = -6.0\text{ V}$ , $R_L = 600\ \Omega$ , $T_A = 25^\circ\text{C}$ , unless otherwise noted.)

Characteristic	Symbol	Min	Typ	Max	Unit
Slew Rate ( $V_{CC} = +2.5\text{ V}$ , $V_{EE} = -2.5\text{ V}$ , $A_V = +1.0$ ) (Note 6)	SR				$\text{V}/\mu\text{s}$
Awakemode		0.5	0.89	–	
Gain Bandwidth Product ( $f = 100\text{ kHz}$ )	GBW				MHz
Awakemode		–	2.2	–	
Gain Margin ( $C_L = 0\text{ pF}$ )	$A_m$				dB
Awakemode		–	6.0	–	
Sleepmode ( $R_L = 1.0\text{ k}\Omega$ )		–	9.0	–	
Phase Margin ( $R_L = 1.0\text{ k}\Omega$ , $V_O = 0\text{ V}$ , $C_L = 0\text{ pF}$ )	$\phi_m$				Deg
Awakemode		–	40	–	
Sleepmode		–	60	–	
Sleepmode to Awakemode Transition Time	$t_{tr1}$				$\mu\text{sec}$
$R_L = 600\ \Omega$		–	4.0	–	
$R_L = 10\text{ k}$		–	12	–	
Awakemode to Sleepmode Transition Time	$t_{tr2}$				sec
Awakemode		–	1.5	–	
Channel Separation ( $f = 1.0\text{ kHz}$ )	CS				dB
Awakemode		–	100	–	

- NOTES:**
- The differential input voltage of each amplifier is limited by two internal diodes. The diodes are connected across the inputs in parallel and opposite to each other. For more differential input voltage range, use current limiting resistors in series with the input pins.
  - The common-mode input voltage range of each amplifier is limited by diodes connected from the inputs to both power supply rails. Therefore, the voltage on either input must not exceed supply rail by more than  $\pm 500\text{ mV}$ .
  - Simultaneous short circuits of two or more amplifiers to the positive or negative rail can exceed the power dissipation ratings and cause eventual failure of the device.
  - Rail-to-rail performance is achieved at the input of the amplifier by using parallel NPN-PNP differential stages. When the inputs are near the negative rail ( $V_{EE} < V_{CM} < 800\text{ mV}$ ), the PNP stage is on. When the inputs are above  $800\text{ mV}$  (i.e.  $800\text{ mV} < V_{CM} < V_{CC}$ ), the NPN stage is on. This switching of the input pairs will cause a reversal of input bias current. Slight changes in the input offset voltage will be noted between the NPN and PNP pairs. Cross-coupling techniques have been used to keep this change to a minimum.
  - Power dissipation must be considered to ensure maximum junction ( $T_J$ ) is not exceeded. (See Figure 2)
  - When connected as a voltage follower and used in transient conditions, a current limiting resistor may be needed between the output and the inverting input. This is because of the back to back diodes clamped across the inputs. The value of this resistor should be between  $1.0\text{ k}\Omega$  and  $10\text{ k}\Omega$ . If the amplifier does not become slew rate limited and is processing low frequency waveforms, then no resistor would be necessary. (The output could be tied directly to the negative input.)

# MC33304

## AC ELECTRICAL CHARACTERISTICS (continued) ( $V_{CC} = +6.0\text{ V}$ , $V_{EE} = -6.0\text{ V}$ , $R_L = 600\ \Omega$ , $T_A = 25^\circ\text{C}$ , unless otherwise noted.)

Characteristic	Symbol	Min	Typ	Max	Unit
Power Bandwidth ( $V_O = 4.0\text{ V}_{pp}$ , $R_L = 2.0\text{ k}\Omega$ , $\text{THD} \leq 1.0\%$ ) Awakemode	$BW_p$	–	28	–	kHz
Distortion ( $V_O = 2.0\text{ V}_{pp}$ , $A_V = +1.0$ ) Awakemode ( $f = 10\text{ kHz}$ ) Sleepmode ( $f = 1.0\text{ kHz}$ , $R_L = \text{Infinite}$ )	THD	– –	0.009 0.007	– –	%
Open Loop Output Impedance ( $V_O = 0\text{ V}$ , $f = 2.0\text{ MHz}$ , $A_V = +10$ , $I_Q = 10\ \mu\text{A}$ ) Awakemode Sleepmode	$ Z_O $	– –	100 1000	– –	$\Omega$
Differential Input Impedance ( $V_{CM} = 0\text{ V}$ ) Awakemode Sleepmode	$R_{IN}$	– –	200 1300	– –	$\text{k}\Omega$
Differential Input Capacitance ( $V_{CM} = 0\text{ V}$ ) Awakemode Sleepmode	$C_{IN}$	– –	8.0 0.4	– –	pF
Equivalent Input Noise Voltage ( $R_S = 100\ \Omega$ , $f = 1.0\text{ kHz}$ ) Awakemode Sleepmode	$e_n$	– –	15 60	– –	$\text{nV}/\sqrt{\text{Hz}}$
Equivalent Input Noise Current ( $f = 1.0\text{ kHz}$ ) Awakemode Sleepmode	$i_n$	– –	0.22 0.20	– –	$\text{pA}/\sqrt{\text{Hz}}$

- NOTES:**
- The differential input voltage of each amplifier is limited by two internal diodes. The diodes are connected across the inputs in parallel and opposite to each other. For more differential input voltage range, use current limiting resistors in series with the input pins.
  - The common-mode input voltage range of each amplifier is limited by diodes connected from the inputs to both power supply rails. Therefore, the voltage on either input must not exceed supply rail by more than  $\pm 500\text{ mV}$ .
  - Simultaneous short circuits of two or more amplifiers to the positive or negative rail can exceed the power dissipation ratings and cause eventual failure of the device.
  - Rail-to-rail performance is achieved at the input of the amplifier by using parallel NPN–PNP differential stages. When the inputs are near the negative rail ( $V_{EE} < V_{CM} < 800\text{ mV}$ ), the PNP stage is on. When the inputs are above  $800\text{ mV}$  (i.e.  $800\text{ mV} < V_{CM} < V_{CC}$ ), the NPN stage is on. This switching of the input pairs will cause a reversal of input bias current. Slight changes in the input offset voltage will be noted between the NPN and PNP pairs. Cross-coupling techniques have been used to keep this change to a minimum.
  - Power dissipation must be considered to ensure maximum junction ( $T_J$ ) is not exceeded. (See Figure 2)
  - When connected as a voltage follower and used in transient conditions, a current limiting resistor may be needed between the output and the inverting input. This is because of the back to back diodes clamped across the inputs. The value of this resistor should be between  $1.0\text{ k}\Omega$  and  $10\text{ k}\Omega$ . If the amplifier does not become slew rate limited and is processing low frequency waveforms, then no resistor would be necessary. (The output could be tied directly to the negative input.)

Figure 1. Equivalent Circuit Block Diagram (Each Amplifier)

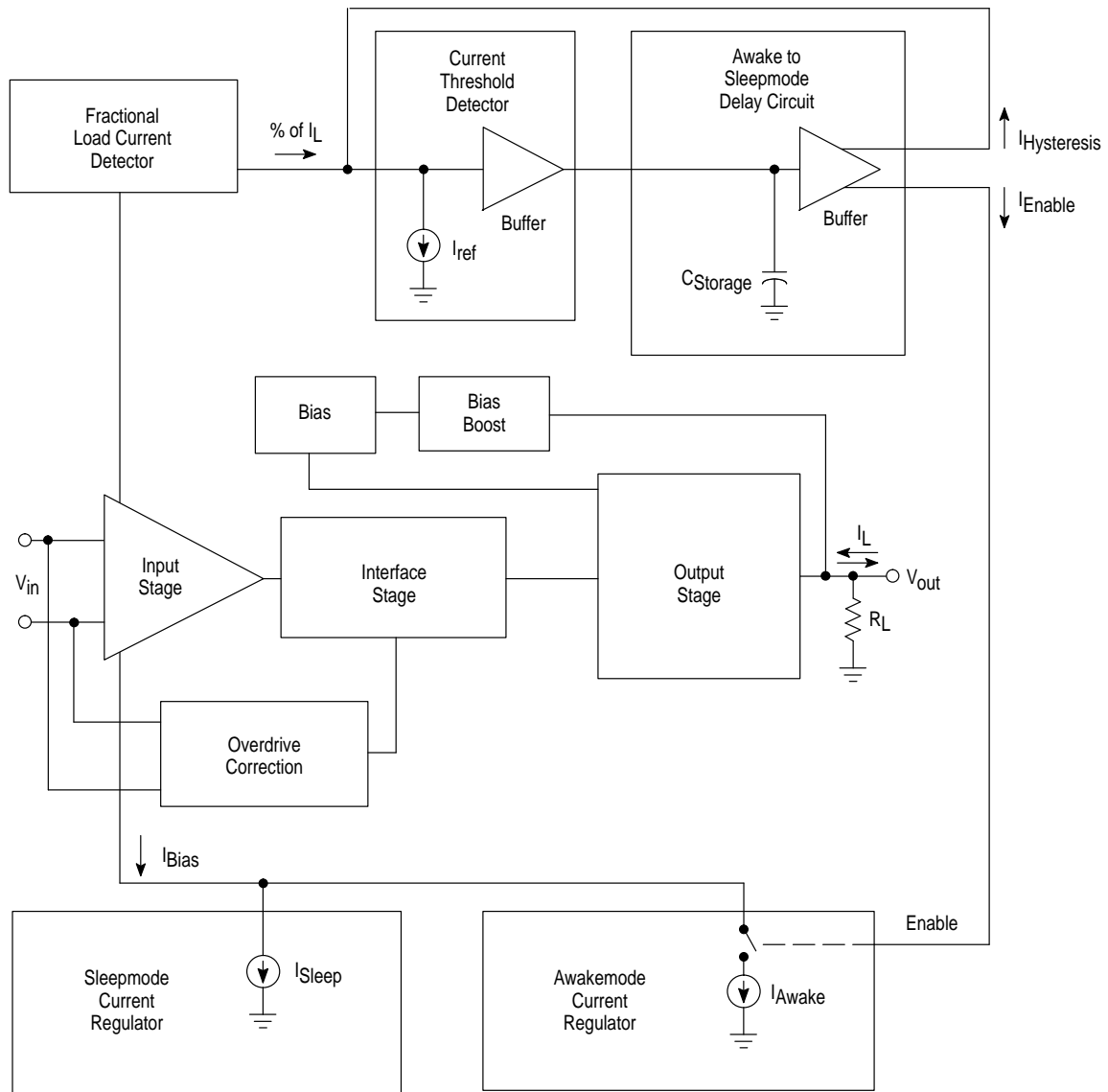

There are 515 active components for the entire quad device.

## DEVICE DESCRIPTION

The MC33304 will begin to function at power supply voltages as low as  $V_S = \pm 0.8$  V. The device has the ability to swing rail-to-rail on both the input and the output. Since the common mode input voltage range extends from  $V_{CC}$  to  $V_{EE}$ , it can be operated with either single or split voltage supplies. The MC33304 is guaranteed not to latch up or phase reverse over the entire common mode range. However, the output could go into phase reversal state if input voltage is set higher than  $+V_{CC}$  or  $-V_{EE}$ .

When power is initially applied, the part may start to operate in the awakemode. This occurs because of bias currents being generated from the charging of the internal capacitors. When this occurs, the user will have to wait approximately 1.5 seconds before the device will switch back to the sleepmode.

The amplifier is designed to switch from sleepmode to awakemode whenever the output current exceeds a preset current threshold ( $I_{TH}$ ) of approximately 200  $\mu$ A. As a result, the output switching threshold voltage ( $V_{ST}$ ) is controlled by the output loading resistance ( $R_L$ ). Large valued load resistors require a large output voltage to switch, but reduce unwanted transitions to the awakemode.

Most of the transition time is consumed slewing in the sleepmode until  $V_{ST}$  is reached, therefore, small values of  $R_L$  allow rapid transition to the awakemode. The output switching threshold voltage ( $V_{ST}$ ) is higher for the larger values of  $R_L$ , requiring the amplifier to slew longer in the slower sleepmode state before switching to the awakemode.

Although typically 200  $\mu$ A,  $I_{TH}$  varies with supply voltage, temperature and the load resistance. Generally, any current loading on the output which causes a current greater than  $I_{TH}$

to flow will switch the amplifier into the awakemode. This includes transition currents like those generated by charging load capacitances. In fact, the maximum capacitance that can be driven while attempting to remain in the sleepmode is approximately 300 pF.

The awakemode to sleepmode transition time is controlled by an internal delay circuit, which is necessary to prevent the amplifier from going to sleep during every zero crossing of the output waveform. This delay circuit also eliminates the crossover distortion commonly found in micropower amplifiers.

The MC33304 rail-to-rail sleepmode operational amplifier is unique in its ability to swing rail-to-rail on both the input and output using a bipolar design. This offers a low noise and wide common mode input voltage range. Since the common mode input voltage range extends from  $V_{CC}$  to  $V_{EE}$ , it can be operated with either single or split voltage supplies.

Rail-to-rail performance is achieved at the input of the amplifiers by using parallel NPN-PNP differential input stages. When the inputs are within 800 mV of the negative rail, the PNP stage is on. When the inputs are more than 800 mV above  $V_{EE}$ , the NPN stage is on. This switching of input pairs will cause a reversal of input bias currents. Also, slight differences in offset voltage may be noted between the NPN and PNP pairs. Cross-coupling techniques have been used to keep this change to a minimum.

In addition to the rail-to-rail performance, the output stage is current boosted to provide enough output current to drive 600  $\Omega$  loads. Because of this high current capability, care should be taken not to exceed the 150°C maximum junction temperature specification.

Figure 2. Maximum Power Dissipation versus Temperature

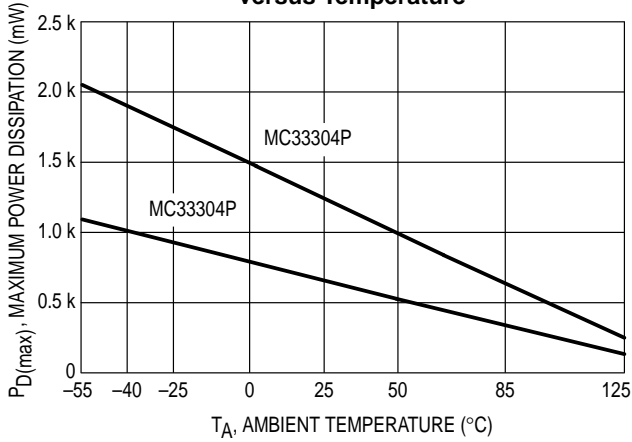

Figure 3. Input Bias Current versus Temperature

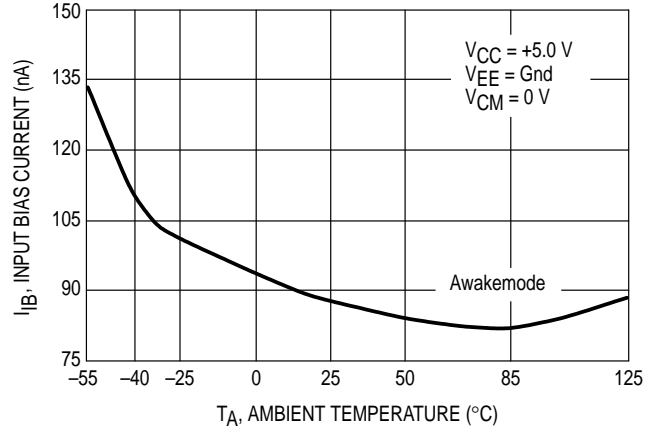

Figure 4. Input Bias Current versus Common Mode Input Voltage

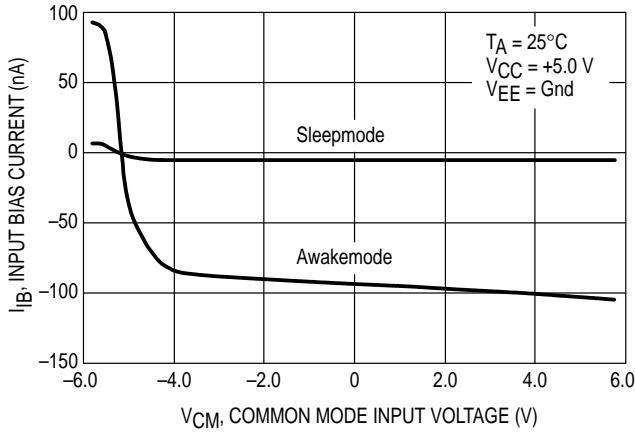

Figure 5. Open Loop Voltage Gain versus Temperature

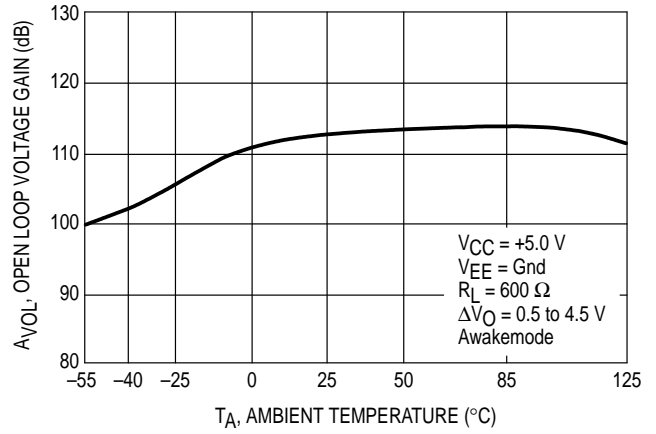

Figure 6. Output Voltage Swing versus Supply Voltage

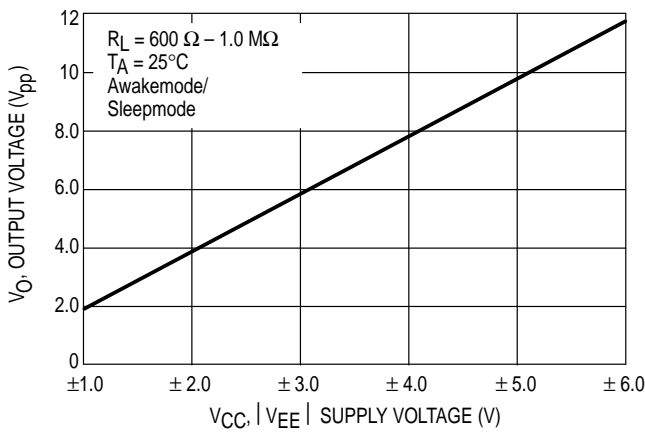

Figure 7. Output Voltage versus Frequency

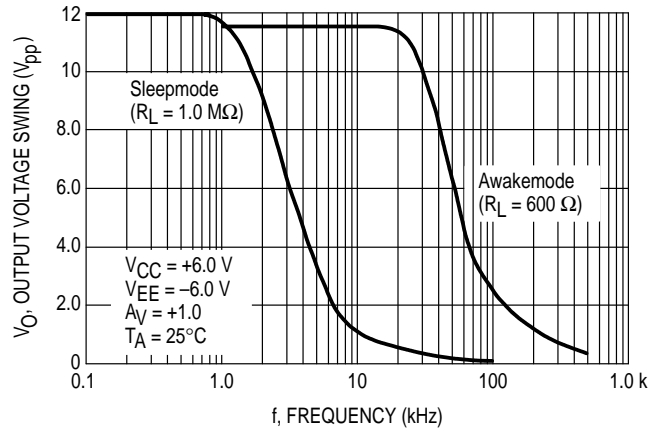

Figure 8. Maximum Peak-to-Peak Output Voltage Swing versus Load Resistance

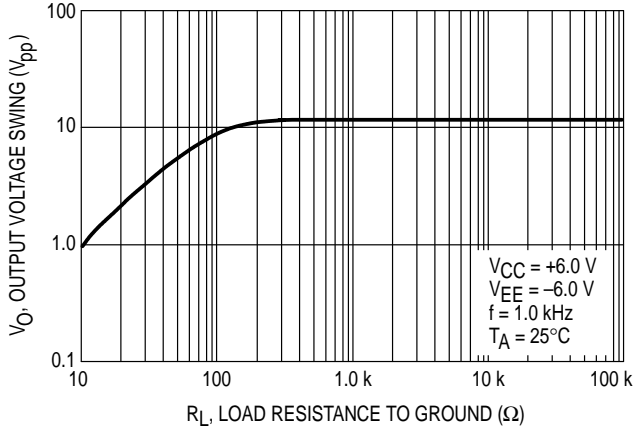

Figure 9. Common Mode Rejection versus Frequency

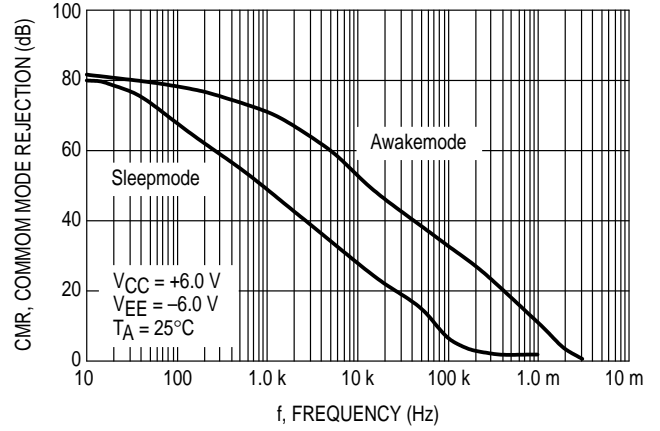

Figure 10. Power Supply Rejection versus Frequency

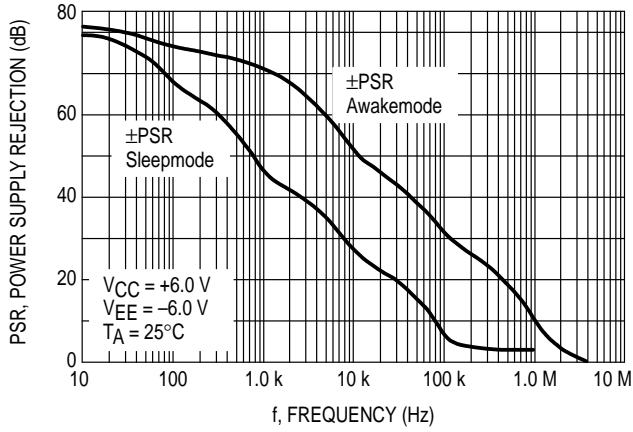

Figure 11. Awakemode to Sleepmode Current Threshold versus Supply Voltage

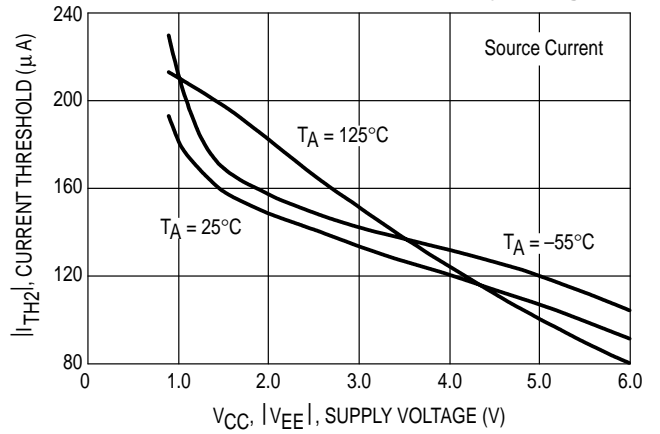

Figure 12. Sleepmode to Awakemode Current Threshold versus Supply Voltage

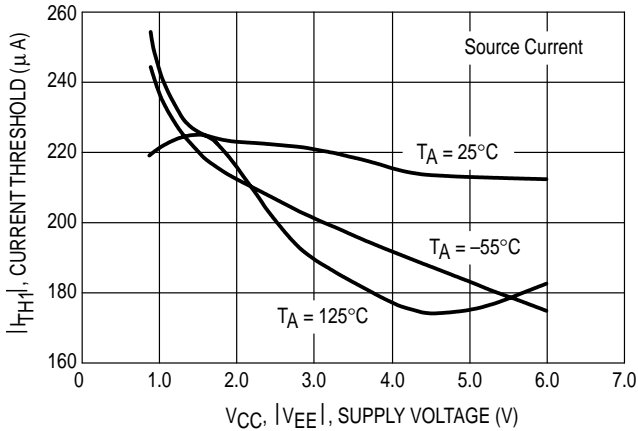

Figure 13. Output Short Circuit Current versus Output Voltage

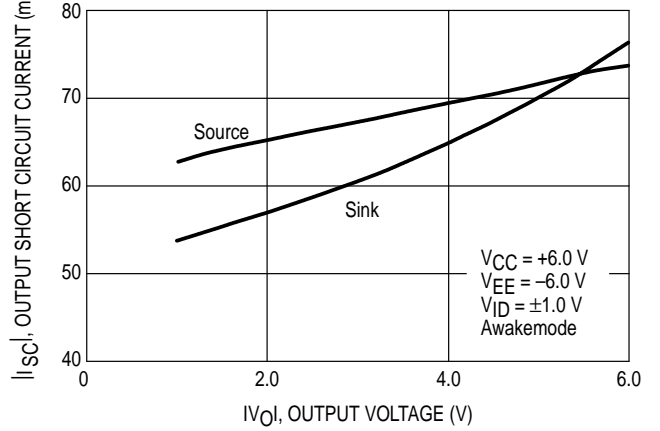



Figure 14. Output Short Circuit Current versus Temperature

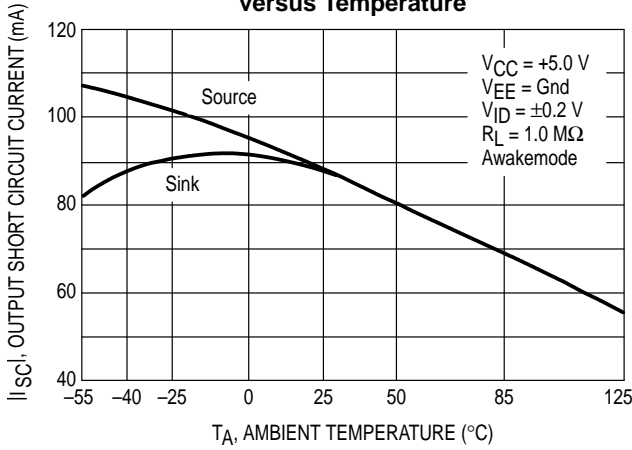

Figure 15. Supply Current versus Supply Voltage with Load

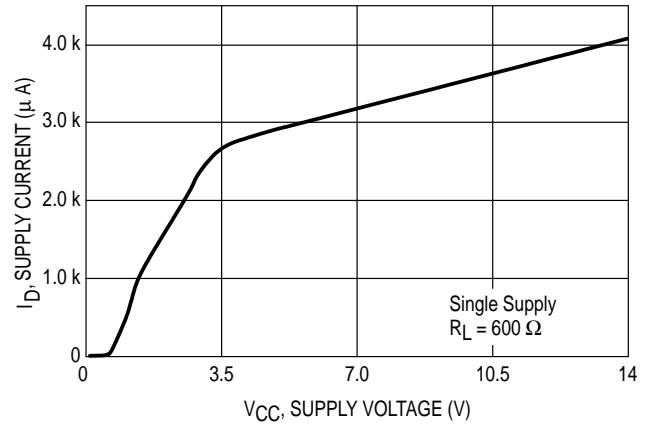

Figure 16. Supply Current versus Supply Voltage

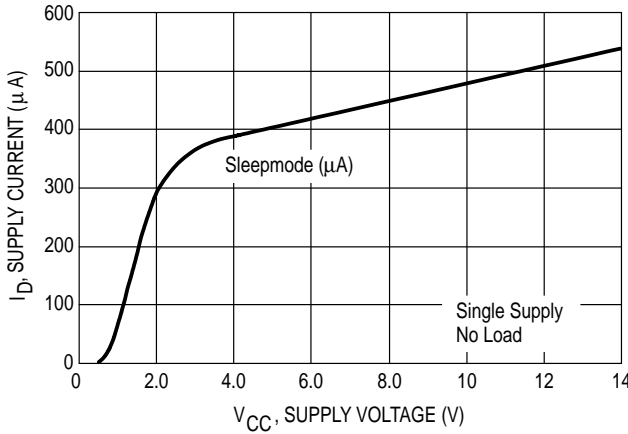

Figure 17. Slew Rate versus Temperature

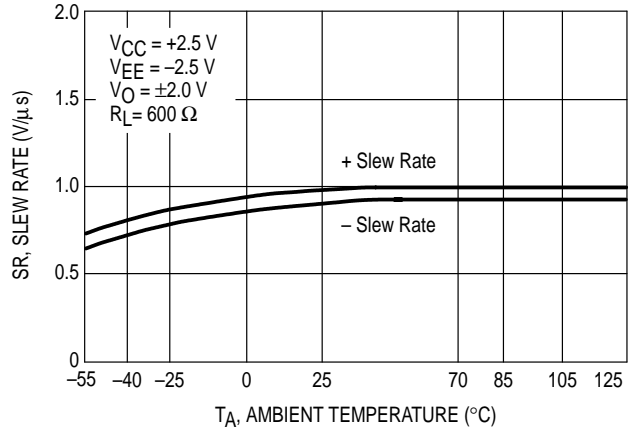

Figure 18. Gain Bandwidth Product versus Temperature

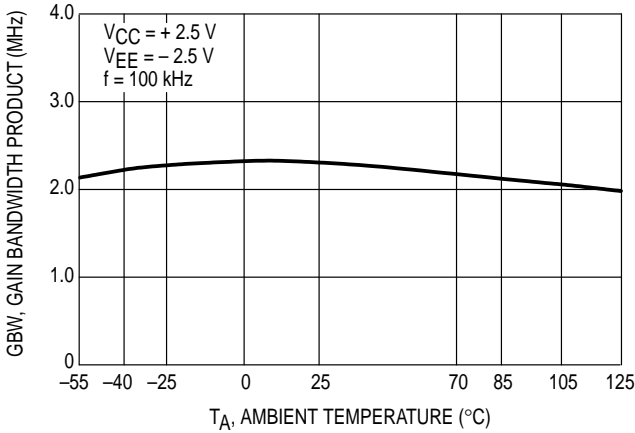
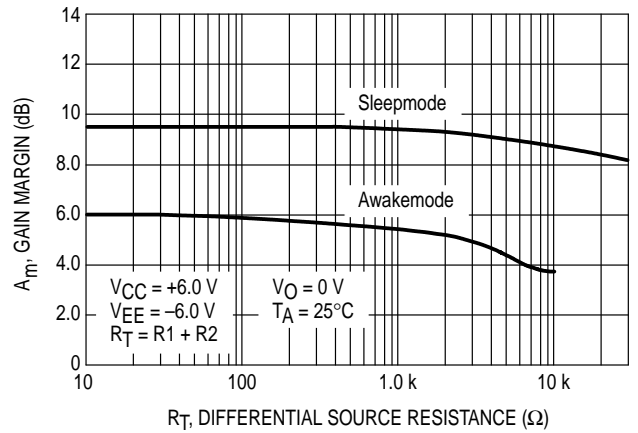
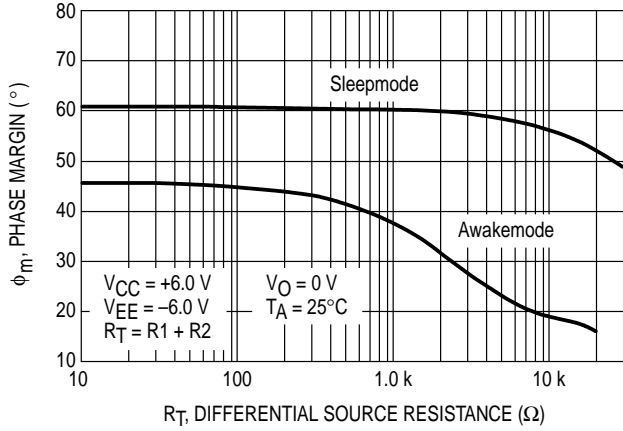

Figure 19. Gain Margin versus Differential Source Resistance



**Figure 20. Phase Margin versus Differential Source Resistance**



**Figure 21. Gain Margin versus Output Load Capacitance**

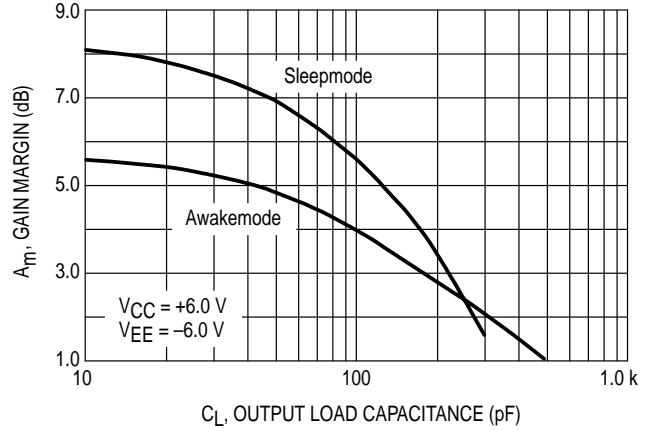

**Figure 22. Phase Margin versus Output Load Capacitance**

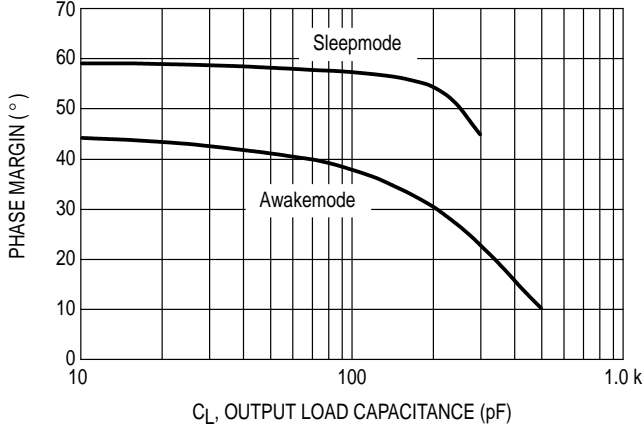

**Figure 23. Channel Separation versus Frequency**

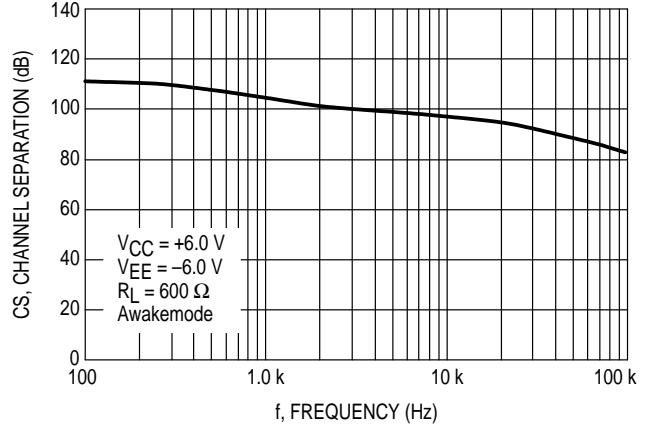

**Figure 24. Total Harmonic Distortion versus Frequency**

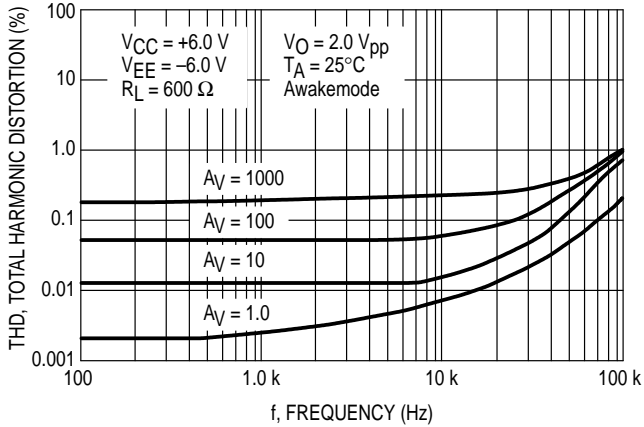

**Figure 25. Input Referred Noise Voltage versus Frequency**

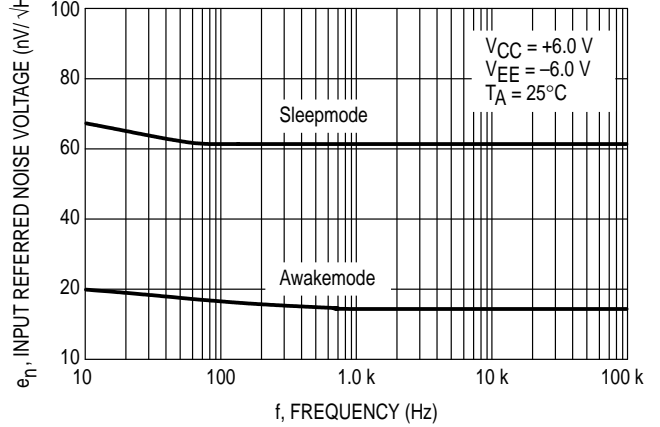

Figure 26. Current Noise versus Frequency

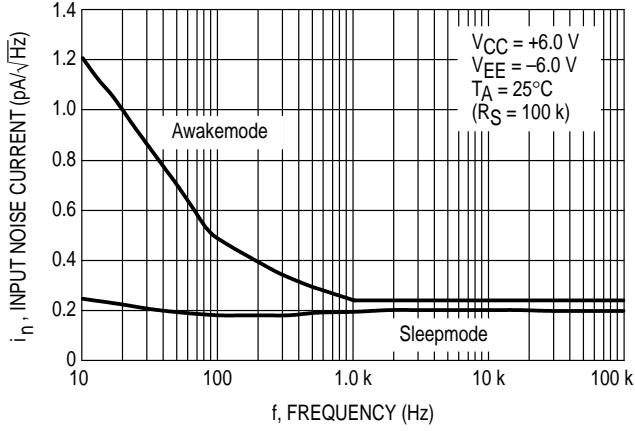
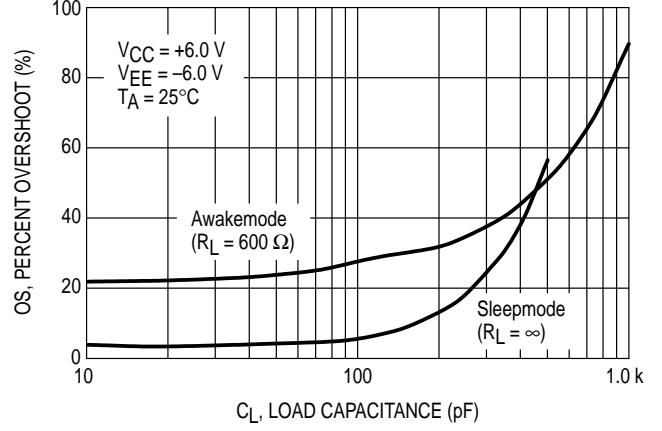

Figure 27. Percent Overshoot versus Load Capacitance



# MC33304

## OUTLINE DIMENSIONS

### P SUFFIX PLASTIC PACKAGE CASE 646-06 ISSUE L

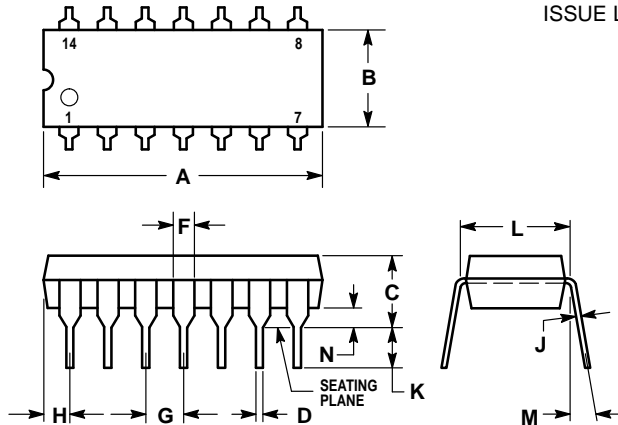

NOTES:

- LEADS WITHIN 0.13 (0.005) RADIUS OF TRUE POSITION AT SEATING PLANE AT MAXIMUM MATERIAL CONDITION.
- DIMENSION L TO CENTER OF LEADS WHEN FORMED PARALLEL.
- DIMENSION B DOES NOT INCLUDE MOLD FLASH.
- ROUNDED CORNERS OPTIONAL.

DIM	INCHES		MILLIMETERS	
	MIN	MAX	MIN	MAX
A	0.715	0.770	18.16	19.56
B	0.240	0.260	6.10	6.60
C	0.145	0.185	3.69	4.69
D	0.015	0.021	0.38	0.53
F	0.040	0.070	1.02	1.78
G	0.100 BSC		2.54 BSC	
H	0.052	0.095	1.32	2.41
J	0.008	0.015	0.20	0.38
K	0.115	0.135	2.92	3.43
L	0.300 BSC		7.62 BSC	
M	0°	10°	0°	10°
N	0.015	0.039	0.39	1.01

### D SUFFIX PLASTIC PACKAGE CASE 751A-03 (SO-14) ISSUE F

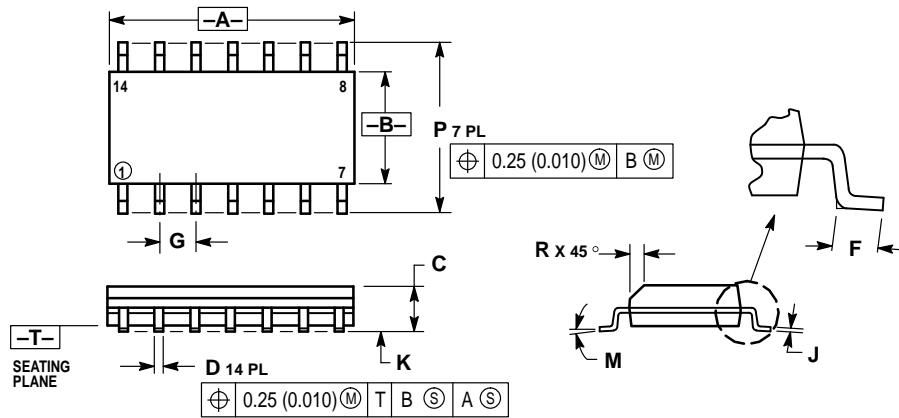

NOTES:

- DIMENSIONING AND TOLERANCING PER ANSI Y14.5M, 1982.
- CONTROLLING DIMENSION: MILLIMETER.
- DIMENSIONS A AND B DO NOT INCLUDE MOLD PROTRUSION.
- MAXIMUM MOLD PROTRUSION 0.15 (0.006) PER SIDE.
- DIMENSION D DOES NOT INCLUDE DAMBAR PROTRUSION. ALLOWABLE DAMBAR PROTRUSION SHALL BE 0.127 (0.005) TOTAL IN EXCESS OF THE D DIMENSION AT MAXIMUM MATERIAL CONDITION.

DIM	MILLIMETERS		INCHES	
	MIN	MAX	MIN	MAX
A	8.55	8.75	0.337	0.344
B	3.80	4.00	0.150	0.157
C	1.35	1.75	0.054	0.068
D	0.35	0.49	0.014	0.019
F	0.40	1.25	0.016	0.049
G	1.27 BSC		0.050 BSC	
J	0.19	0.25	0.008	0.009
K	0.10	0.25	0.004	0.009
M	0°	7°	0°	7°
P	5.80	6.20	0.228	0.244
R	0.25	0.50	0.010	0.019

Motorola reserves the right to make changes without further notice to any products herein. Motorola makes no warranty, representation or guarantee regarding the suitability of its products for any particular purpose, nor does Motorola assume any liability arising out of the application or use of any product or circuit, and specifically disclaims any and all liability, including without limitation consequential or incidental damages. "Typical" parameters can and do vary in different applications. All operating parameters, including "Typicals" must be validated for each customer application by customer's technical experts. Motorola does not convey any license under its patent rights nor the rights of others. Motorola products are not designed, intended, or authorized for use as components in systems intended for surgical implant into the body, or other applications intended to support or sustain life, or for any other application in which the failure of the Motorola product could create a situation where personal injury or death may occur. Should Buyer purchase or use Motorola products for any such unintended or unauthorized application, Buyer shall indemnify and hold Motorola and its officers, employees, subsidiaries, affiliates, and distributors harmless against all claims, costs, damages, and expenses, and reasonable attorney fees arising out of, directly or indirectly, any claim of personal injury or death associated with such unintended or unauthorized use, even if such claim alleges that Motorola was negligent regarding the design or manufacture of the part. Motorola and are registered trademarks of Motorola, Inc. Motorola, Inc. is an Equal Opportunity/Affirmative Action Employer.

**How to reach us:**

**USA / EUROPE:** Motorola Literature Distribution;  
P.O. Box 20912; Phoenix, Arizona 85036. 1-800-441-2447

**MFAX:** RMFAX0@email.sps.mot.com - TOUCHTONE (602) 244-6609  
**INTERNET:** http://Design-NET.com

**JAPAN:** Nippon Motorola Ltd.; Tatsumi-SPD-JLDC, Toshikatsu Otsuki,  
6F Seibu-Butsuryu-Center, 3-14-2 Tatsumi Koto-Ku, Tokyo 135, Japan. 03-3521-8315

**HONG KONG:** Motorola Semiconductors H.K. Ltd.; 8B Tai Ping Industrial Park,  
51 Ting Kok Road, Tai Po, N.T., Hong Kong. 852-26629298

