

Amplifier Transistors

PNP Silicon

BC556,B
BC557A,B,C
BC558B

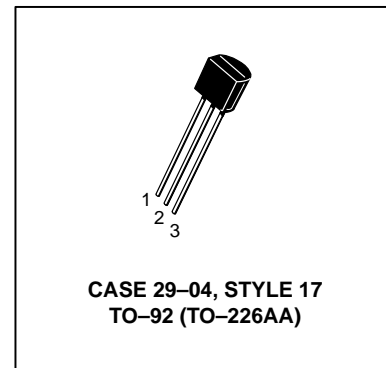

MAXIMUM RATINGS

Rating	Symbol	BC 556	BC 557	BC 558	Unit
Collector–Emitter Voltage	V_{CEO}	-65	-45	-30	Vdc
Collector–Base Voltage	V_{CBO}	-80	-50	-30	Vdc
Emitter–Base Voltage	V_{EBO}	-5.0			Vdc
Collector Current — Continuous	I_C	-100			mAdc
Total Device Dissipation @ $T_A = 25^\circ\text{C}$ Derate above 25°C	P_D	625 5.0			mW mW/ $^\circ\text{C}$
Total Device Dissipation @ $T_C = 25^\circ\text{C}$ Derate above 25°C	P_D	1.5 12			Watt mW/ $^\circ\text{C}$
Operating and Storage Junction Temperature Range	T_J, T_{stg}	-55 to +150			$^\circ\text{C}$

THERMAL CHARACTERISTICS

Characteristic	Symbol	Max	Unit
Thermal Resistance, Junction to Ambient	$R_{\theta JA}$	200	$^\circ\text{C/W}$
Thermal Resistance, Junction to Case	$R_{\theta JC}$	83.3	$^\circ\text{C/W}$

ELECTRICAL CHARACTERISTICS ($T_A = 25^\circ\text{C}$ unless otherwise noted)

Characteristic	Symbol	Min	Typ	Max	Unit
----------------	--------	-----	-----	-----	------

OFF CHARACTERISTICS

Collector–Emitter Breakdown Voltage ($I_C = -2.0 \text{ mAdc}, I_B = 0$)	BC556 BC557 BC558	$V_{(BR)CEO}$	-65 -45 -30	— — —	— — —	V
Collector–Base Breakdown Voltage ($I_C = -100 \mu\text{Adc}$)	BC556 BC557 BC558	$V_{(BR)CBO}$	-80 -50 -30	— — —	— — —	V
Emitter–Base Breakdown Voltage ($I_E = -100 \mu\text{Adc}, I_C = 0$)	BC556 BC557 BC558	$V_{(BR)EBO}$	-5.0 -5.0 -5.0	— — —	— — —	V
Collector–Emitter Leakage Current ($V_{CES} = -40 \text{ V}$) ($V_{CES} = -20 \text{ V}$)	BC556 BC557 BC558	I_{CES}	— — —	-2.0 -2.0 -2.0	-100 -100 -100	nA
($V_{CES} = -20 \text{ V}, T_A = 125^\circ\text{C}$)	BC556 BC557 BC558		— — —	— — —	-4.0 -4.0 -4.0	μA

BC556,B BC557A,B,C BC558B
ELECTRICAL CHARACTERISTICS ($T_A = 25^\circ\text{C}$ unless otherwise noted) (Continued)

Characteristic	Symbol	Min	Typ	Max	Unit
ON CHARACTERISTICS					
DC Current Gain ($I_C = -10 \mu\text{A}$, $V_{CE} = -5.0 \text{ V}$)	h_{FE}	—	90	—	—
	BC557A	—	150	—	—
	BC556B/557B/558B	—	270	—	—
	BC557C	—	270	—	—
($I_C = -2.0 \text{ mA}$, $V_{CE} = -5.0 \text{ V}$)	BC556	120	—	500	—
	BC557	120	—	800	—
	BC558	120	—	800	—
	BC557A	120	170	220	—
	BC556B/557B/558B	180	290	460	—
	BC557C	420	500	800	—
($I_C = -100 \text{ mA}$, $V_{CE} = -5.0 \text{ V}$)	BC557A	—	120	—	—
	BC556B/557B/558B	—	180	—	—
	BC557C	—	300	—	—
Collector–Emitter Saturation Voltage ($I_C = -10 \text{ mA}$, $I_B = -0.5 \text{ mA}$) ($I_C = -10 \text{ mA}$, $I_B = \text{see Note 1}$) ($I_C = -100 \text{ mA}$, $I_B = -5.0 \text{ mA}$)	$V_{CE(\text{sat})}$	—	-0.075	-0.3	V
		—	-0.3	-0.6	
		—	-0.25	-0.65	
Base–Emitter Saturation Voltage ($I_C = -10 \text{ mA}$, $I_B = -0.5 \text{ mA}$) ($I_C = -100 \text{ mA}$, $I_B = -5.0 \text{ mA}$)	$V_{BE(\text{sat})}$	—	-0.7	—	V
		—	-1.0	—	
Base–Emitter On Voltage ($I_C = -2.0 \text{ mA}$, $V_{CE} = -5.0 \text{ Vdc}$) ($I_C = -10 \text{ mA}$, $V_{CE} = -5.0 \text{ Vdc}$)	$V_{BE(\text{on})}$	-0.55	-0.62	-0.7	V
		—	-0.7	-0.82	

SMALL–SIGNAL CHARACTERISTICS

Current–Gain — Bandwidth Product ($I_C = -10 \text{ mA}$, $V_{CE} = -5.0 \text{ V}$, $f = 100 \text{ MHz}$)	f_T	—	280	—	MHz
	BC556	—	320	—	
	BC557	—	360	—	
	BC558	—	360	—	
Output Capacitance ($V_{CB} = -10 \text{ V}$, $I_C = 0$, $f = 1.0 \text{ MHz}$)	C_{ob}	—	3.0	6.0	pF
Noise Figure ($I_C = -0.2 \text{ mA}$, $V_{CE} = -5.0 \text{ V}$, $R_S = 2.0 \text{ k}\Omega$, $f = 1.0 \text{ kHz}$, $\Delta f = 200 \text{ Hz}$)	NF	—	2.0	10	dB
	BC556	—	2.0	10	
	BC557	—	2.0	10	
	BC558	—	2.0	10	
Small–Signal Current Gain ($I_C = -2.0 \text{ mA}$, $V_{CE} = -5.0 \text{ V}$, $f = 1.0 \text{ kHz}$)	h_{fe}	125	—	500	—
	BC556	125	—	900	
	BC557/558	125	220	260	
	BC557A	240	330	500	
	BC556B/557B/558B	450	600	900	
	BC557C	450	600	900	

Note 1: $I_C = -10 \text{ mA}$ on the constant base current characteristics, which yields the point $I_C = -11 \text{ mA}$, $V_{CE} = -1.0 \text{ V}$.

BC557/BC558

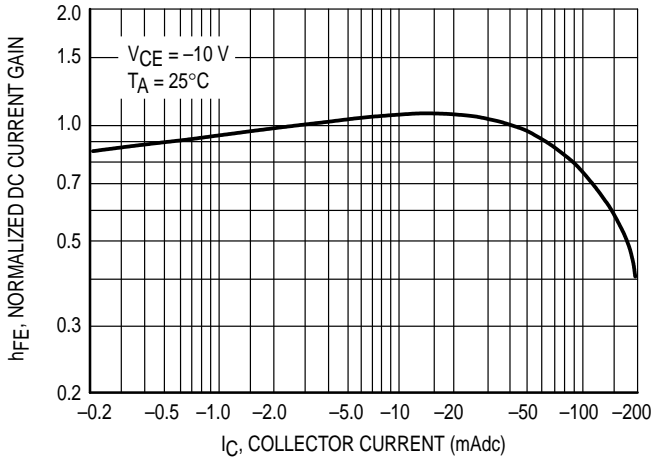

Figure 1. Normalized DC Current Gain

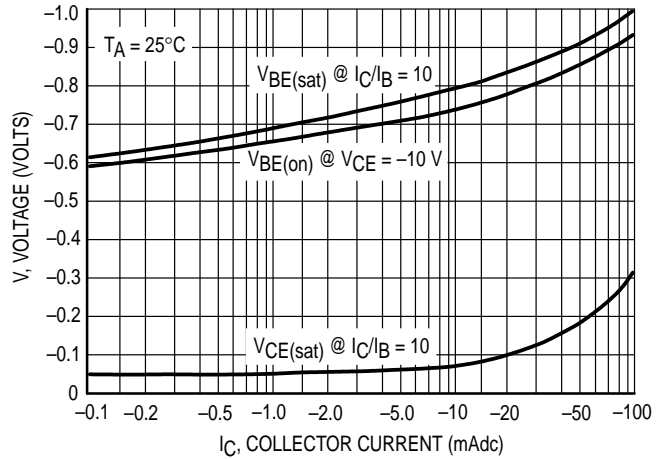

Figure 2. "Saturation" and "On" Voltages

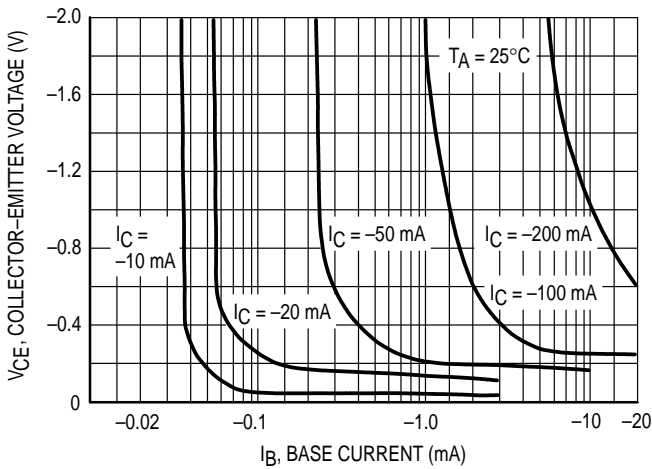

Figure 3. Collector Saturation Region

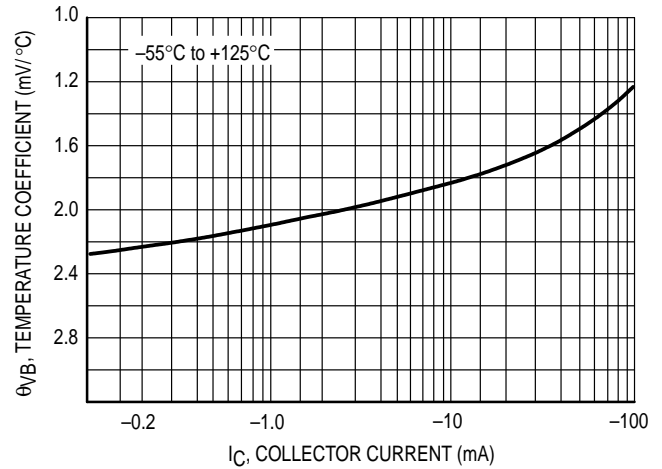

Figure 4. Base-Emitter Temperature Coefficient

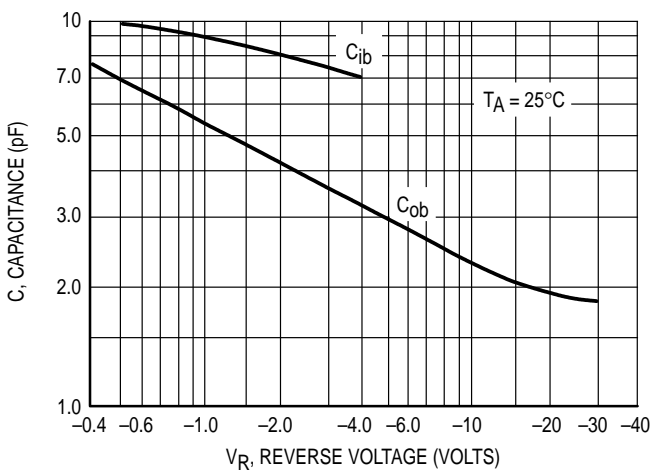

Figure 5. Capacitances

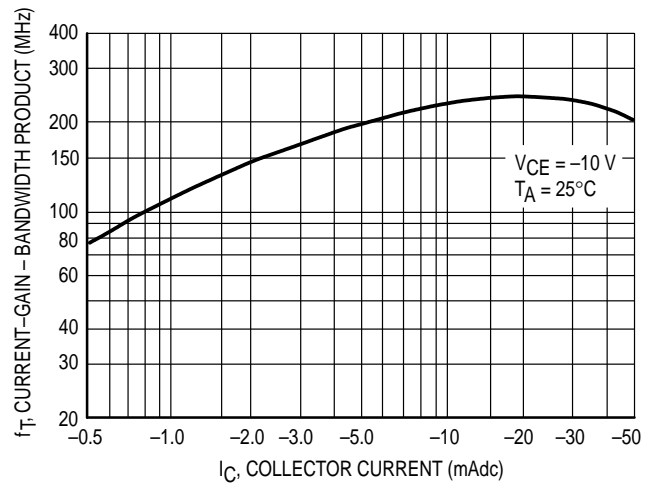

Figure 6. Current-Gain - Bandwidth Product

BC556

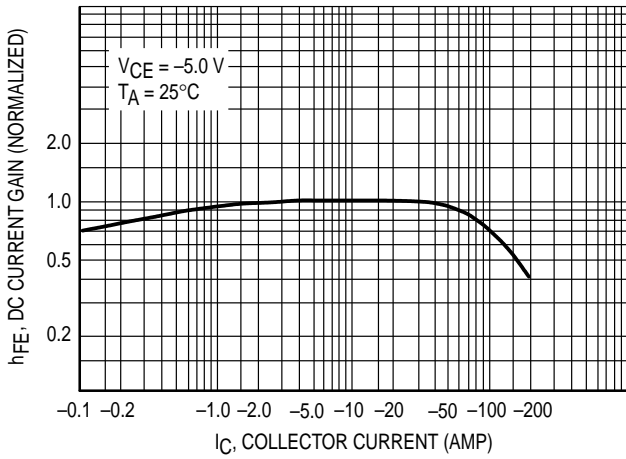

Figure 7. DC Current Gain

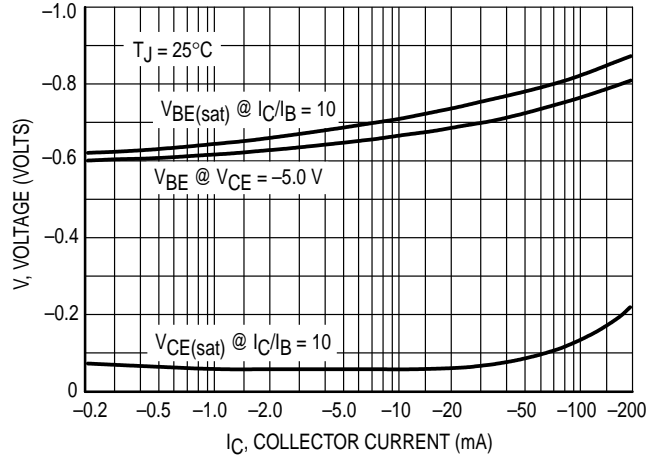

Figure 8. "On" Voltage

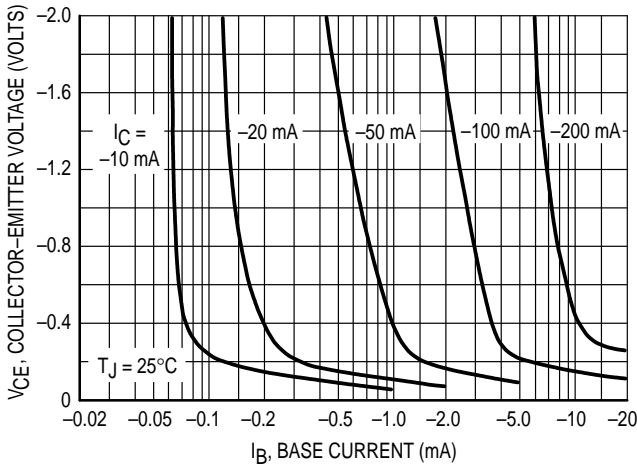

Figure 9. Collector Saturation Region

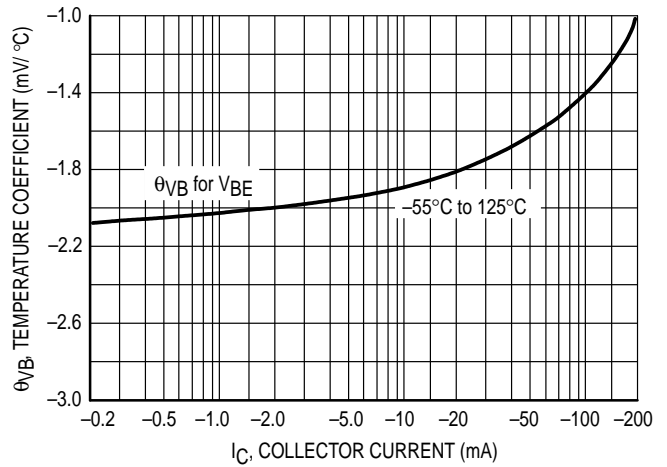

Figure 10. Base-Emitter Temperature Coefficient

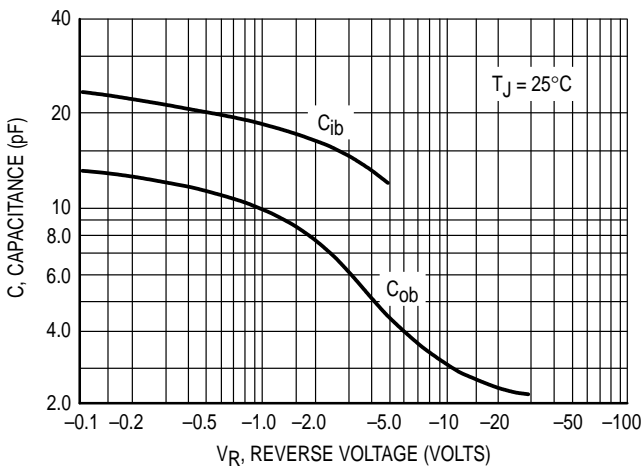

Figure 11. Capacitance

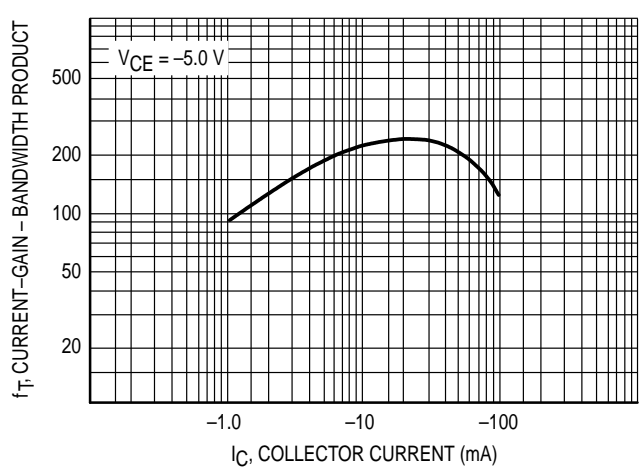

Figure 12. Current-Gain - Bandwidth Product

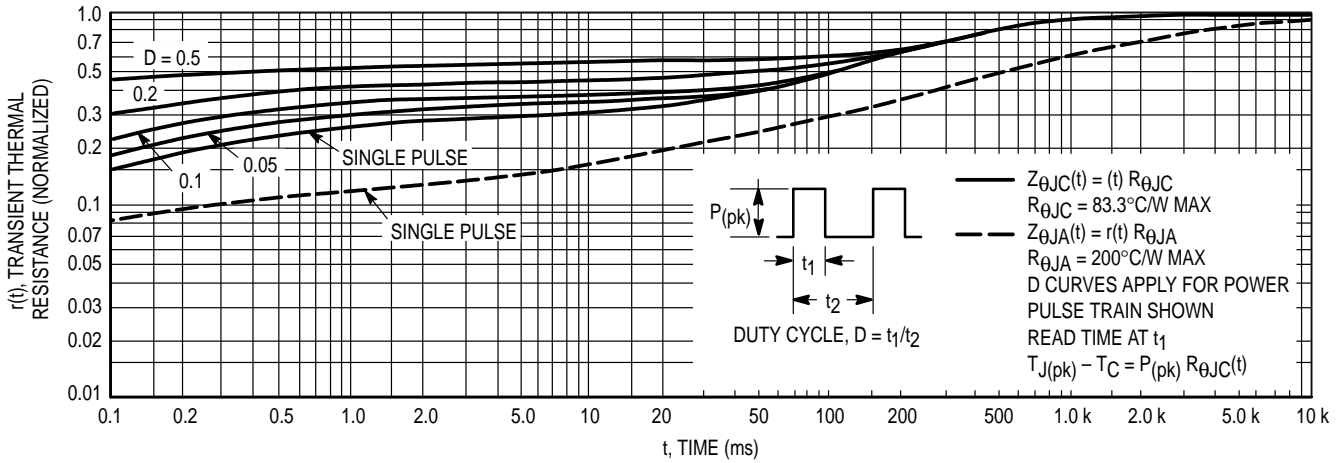

Figure 13. Thermal Response

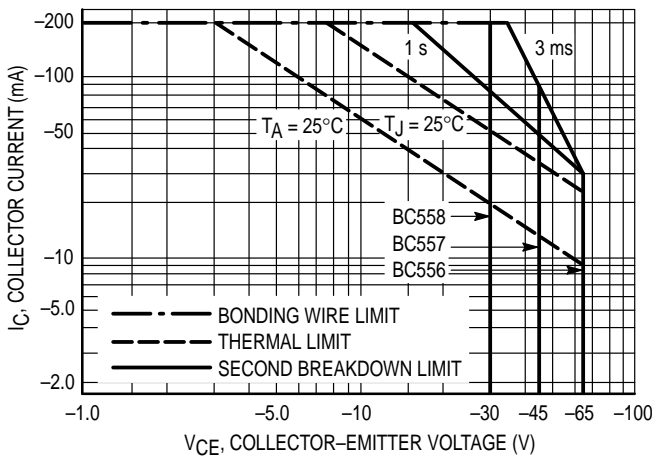

Figure 14. Active Region — Safe Operating Area

The safe operating area curves indicate I_C - V_{CE} limits of the transistor that must be observed for reliable operation. Collector load lines for specific circuits must fall below the limits indicated by the applicable curve.

The data of Figure 14 is based upon $T_{J(pk)} = 150^\circ\text{C}$; T_C or T_A is variable depending upon conditions. Pulse curves are valid for duty cycles to 10% provided $T_{J(pk)} \leq 150^\circ\text{C}$. $T_{J(pk)}$ may be calculated from the data in Figure 13. At high case or ambient temperatures, thermal limitations will reduce the power than can be handled to values less than the limitations imposed by second breakdown.

PACKAGE DIMENSIONS



- NOTES:
1. DIMENSIONING AND TOLERANCING PER ANSI Y14.5M, 1982.
 2. CONTROLLING DIMENSION: INCH.
 3. CONTOUR OF PACKAGE BEYOND DIMENSION R IS UNCONTROLLED.
 4. DIMENSION F APPLIES BETWEEN P AND L. DIMENSION D AND J APPLY BETWEEN L AND K. MINIMUM LEAD DIMENSION IS UNCONTROLLED IN P AND BEYOND DIMENSION K MINIMUM.

DIM	INCHES		MILLIMETERS	
	MIN	MAX	MIN	MAX
A	0.175	0.205	4.45	5.20
B	0.170	0.210	4.32	5.33
C	0.125	0.165	3.18	4.19
D	0.016	0.022	0.41	0.55
F	0.016	0.019	0.41	0.48
G	0.045	0.055	1.15	1.39
H	0.095	0.105	2.42	2.66
J	0.015	0.020	0.39	0.50
K	0.500	—	12.70	—
L	0.250	—	6.35	—
N	0.080	0.105	2.04	2.66
P	—	0.100	—	2.54
R	0.115	—	2.93	—
V	0.135	—	3.43	—

CASE 029-04
(TO-226AA)
ISSUE AD

- STYLE 17:
1. COLLECTOR
 2. BASE
 3. EMITTER

Motorola reserves the right to make changes without further notice to any products herein. Motorola makes no warranty, representation or guarantee regarding the suitability of its products for any particular purpose, nor does Motorola assume any liability arising out of the application or use of any product or circuit, and specifically disclaims any and all liability, including without limitation consequential or incidental damages. "Typical" parameters can and do vary in different applications. All operating parameters, including "Typicals" must be validated for each customer application by customer's technical experts. Motorola does not convey any license under its patent rights nor the rights of others. Motorola products are not designed, intended, or authorized for use as components in systems intended for surgical implant into the body, or other applications intended to support or sustain life, or for any other application in which the failure of the Motorola product could create a situation where personal injury or death may occur. Should Buyer purchase or use Motorola products for any such unintended or unauthorized application, Buyer shall indemnify and hold Motorola and its officers, employees, subsidiaries, affiliates, and distributors harmless against all claims, costs, damages, and expenses, and reasonable attorney fees arising out of, directly or indirectly, any claim of personal injury or death associated with such unintended or unauthorized use, even if such claim alleges that Motorola was negligent regarding the design or manufacture of the part. Motorola and are registered trademarks of Motorola, Inc. Motorola, Inc. is an Equal Opportunity/Affirmative Action Employer.

How to reach us:

USA/EUROPE: Motorola Literature Distribution;
P.O. Box 20912; Phoenix, Arizona 85036. 1-800-441-2447

JAPAN: Nippon Motorola Ltd.; Tatsumi-SPD-JLDC, Toshikatsu Otsuki,
6F Seibu-Butsuryu-Center, 3-14-2 Tatsumi Koto-Ku, Tokyo 135, Japan. 03-3521-8315

MFAX: RMFAX0@email.sps.mot.com - TOUCHTONE (602) 244-6609
INTERNET: http://Design-NET.com

HONG KONG: Motorola Semiconductors H.K. Ltd.; 8B Tai Ping Industrial Park,
51 Ting Kok Road, Tai Po, N.T., Hong Kong. 852-26629298

