

MC14049UB

Hex Buffers

The MC14049UB hex inverter/buffer is constructed with MOS P-channel and N-channel enhancement mode devices in a single monolithic structure. This complementary MOS device finds primary use where low power dissipation and/or high noise immunity is desired. This device provides logic-level conversion using only one supply voltage, V_{DD} . The input-signal high level (V_{IH}) can exceed the V_{DD} supply voltage for logic-level conversions. Two TTL/DTL Loads can be driven when the device is used as CMOS-to-TTL/DTL converters ($V_{DD} = 5.0\text{ V}$, $V_{OL} \leq 0.4\text{ V}$, $I_{OL} \geq 3.2\text{ mA}$). Note that pins 13 and 16 are not connected internally on this device; consequently connections to these terminals will not affect circuit operation.

- High Source and Sink Currents
- High-to-Low Level Converter
- Supply Voltage Range = 3.0 V to 18 V
- Meets JEDEC UB Specifications
- V_{IN} can exceed V_{DD}
- Improved ESD Protection on All Inputs

MAXIMUM RATINGS* (Voltages Referenced to V_{SS})

Rating	Symbol	Value	Unit
DC Supply Voltage	V_{DD}	- 0.5 to + 18	V
Input Voltage (DC or Transient)	V_{in}	- 0.5 to + 18	V
Output Voltage (DC or Transient)	V_{out}	- 0.5 to $V_{DD} + 0.5$	V
Input Current (DC or Transient), per Pin	I_{in}	± 10	mA
Output Current (DC or Transient), per Pin	I_{out}	+ 45	mA
Power Dissipation, per Package† Plastic/Ceramic SOIC	P_D	825 740	mW
Storage Temperature	T_{stg}	- 65 to + 150	°C
Lead Temperature (8-Second Soldering)	T_L	260	°C

* Maximum Ratings are those values beyond which damage to the device may occur.
† Temperature Derating: All Packages: See Figure 4.

CIRCUIT SCHEMATIC
(1/6 OF CIRCUIT SHOWN)

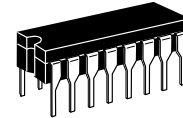
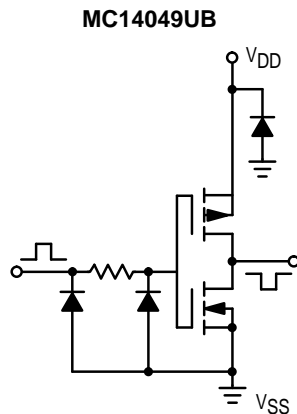

L SUFFIX
CERAMIC
CASE 620

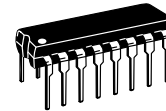

P SUFFIX
PLASTIC
CASE 648

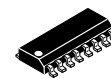

D SUFFIX
SOIC
CASE 751B

ORDERING INFORMATION

MC14XXXBCP	Plastic
MC14XXXBCL	Ceramic
MC14XXXBD	SOIC

$T_A = -55^\circ$ to 125°C for all packages.

LOGIC DIAGRAM
MC14049UB

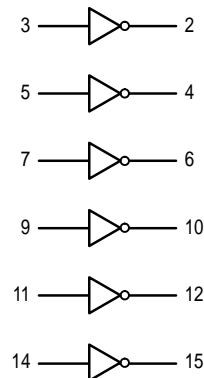

NC = PIN 13, 16
 V_{SS} = PIN 8
 V_{DD} = PIN 1



ELECTRICAL CHARACTERISTICS (Voltages Referenced to V_{SS})

Characteristic	Symbol	V _{DD} Vdc	- 55°C		25°C			125°C		Unit	
			Min	Max	Min	Typ	Max	Min	Max		
Output Voltage V _{in} = V _{DD} or 0	"0" Level	V _{OL}	5.0	—	0.05	—	0	0.05	—	0.05	Vdc
		10	—	0.05	—	0	0.05	—	0.05		
		15	—	0.05	—	0	0.05	—	0.05		
	"1" Level	V _{OH}	5.0	4.95	—	4.95	5.0	—	4.95	—	Vdc
		10	9.95	—	9.95	10	—	9.95	—		
		15	14.95	—	14.95	15	—	14.95	—		
Input Voltage (V _O = 4.5 Vdc) (V _O = 9.0 Vdc) (V _O = 13.5 Vdc)	"0" Level	V _{IL}	5.0	—	1.0	—	2.25	1.0	—	1.0	Vdc
		10	—	2.0	—	4.50	2.0	—	2.0		
		15	—	2.5	—	6.75	2.5	—	2.5		
	"1" Level	V _{IH}	5.0	4.0	—	4.0	2.75	—	4.0	—	Vdc
		10	8.0	—	8.0	5.50	—	8.0	—		
		15	12.5	—	12.5	8.25	—	12.5	—		
Output Drive Current (V _{OH} = 2.5 Vdc) (V _{OH} = 9.5 Vdc) (V _{OH} = 13.5 Vdc)	Source	I _{OH}	5.0	-1.6	—	-1.25	-2.5	—	-1.0	—	mAdc
		10	-1.6	—	-1.3	-2.6	—	-1.0	—		
		15	-4.7	—	-3.75	-10	—	-3.0	—		
	Sink	I _{OL}	5.0	3.75	—	3.2	6.0	—	2.6	—	mAdc
		10	10	—	8.0	16	—	6.6	—		
		15	30	—	24	40	—	19	—		
Input Current	I _{in}	15	—	± 0.1	—	± 0.00001	± 0.1	—	± 1.0	μAdc	
Input Capacitance (V _{in} = 0)	C _{in}	—	—	—	—	10	20	—	—	pF	
Quiescent Current (Per Package)	I _{DD}	5.0	—	1.0	—	0.002	1.0	—	30	μAdc	
		10	—	2.0	—	0.004	2.0	—	60		
		15	—	4.0	—	0.006	4.0	—	120		
Total Supply Current**† (Dynamic plus Quiescent, Per Package) (C _L = 50 pF on all outputs, all buffers switching)	I _T	5.0	I _T = (1.8 μA/kHz) f + I _{DD}							μAdc	
		10	I _T = (3.5 μA/kHz) f + I _{DD}								
		15	I _T = (5.3 μA/kHz) f + I _{DD}								

#Data labelled "Typ" is not to be used for design purposes but is intended as an indication of the IC's potential performance.

** The formulas given are for the typical characteristics only at 25°C.

† To calculate total supply current at loads other than 50 pF:

$$I_T(C_L) = I_T(50 \text{ pF}) + (C_L - 50) Vfk$$

where: I_T is in μA (per package), C_L in pF, V = (V_{DD} - V_{SS}) in volts, f in kHz is input frequency, and k = 0.002.

SWITCHING CHARACTERISTICS* ($C_L = 50 \text{ pF}$, $T_A = 25^\circ\text{C}$)

Characteristic	Symbol	V _{DD} Vdc	Min	Typ #	Max	Unit
Output Rise Time $t_{TLH} = (0.8 \text{ ns/pF}) C_L + 60 \text{ ns}$ $t_{TLH} = (0.3 \text{ ns/pF}) C_L + 35 \text{ ns}$ $t_{TLH} = (0.27 \text{ ns/pF}) C_L + 26.5 \text{ ns}$	t_{TLH}	5.0 10 15	— — —	100 50 40	160 100 60	ns
Output Fall Time $t_{THL} = (0.3 \text{ ns/pF}) C_L + 25 \text{ ns}$ $t_{THL} = (0.12 \text{ ns/pF}) C_L + 14 \text{ ns}$ $t_{THL} = (0.1 \text{ ns/pF}) C_L + 10 \text{ ns}$	t_{THL}	5.0 10 15	— — —	40 20 15	60 40 30	ns
Propagation Delay Time $t_{PLH} = (0.38 \text{ ns/pF}) C_L + 61 \text{ ns}$ $t_{PLH} = (0.20 \text{ ns/pF}) C_L + 30 \text{ ns}$ $t_{PLH} = (0.11 \text{ ns/pF}) C_L + 24.5 \text{ ns}$	t_{PLH}	5.0 10 15	— — —	80 40 30	120 65 50	ns
Propagation Delay Time $t_{PHL} = (0.38 \text{ ns/pF}) C_L + 11 \text{ ns}$ $t_{PHL} = (0.12 \text{ ns/pF}) C_L + 9 \text{ ns}$ $t_{PHL} = (0.11 \text{ ns/pF}) C_L + 4.5 \text{ ns}$	t_{PHL}	5.0 10 15	— — —	30 15 10	60 30 20	ns

* The formulas given are for the typical characteristics only at 25°C.

#Data labelled "Typ" is not to be used for design purposes but is intended as an indication of the IC's potential performance.

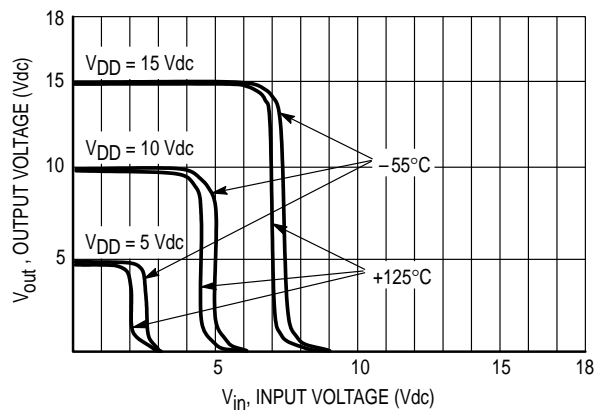

Figure 1. Typical Voltage Transfer Characteristics versus Temperature

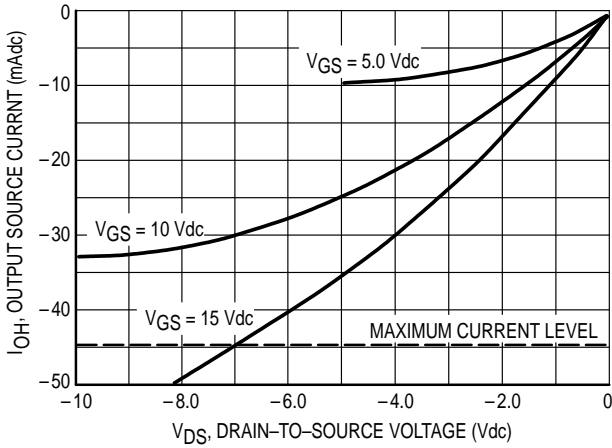
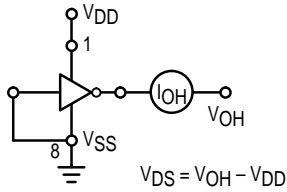

Figure 2. Typical Output Source Characteristics

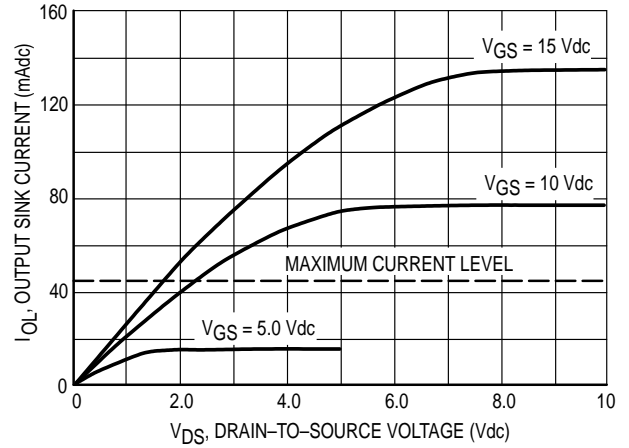
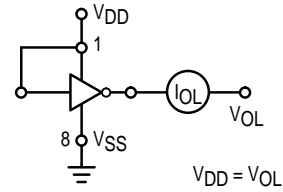

Figure 3. Typical Output Sink Characteristics

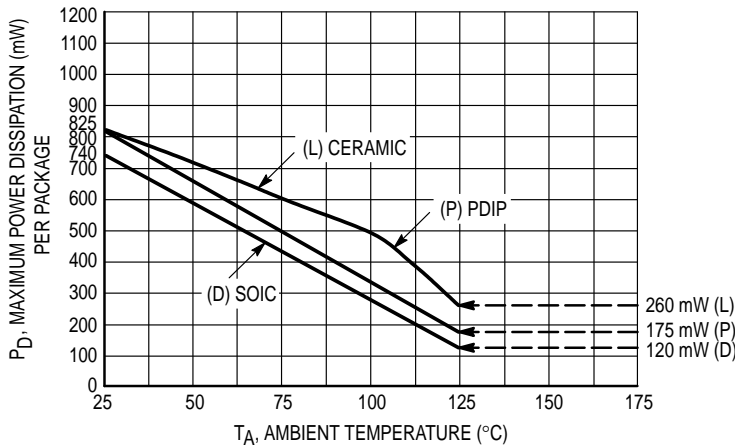

Figure 4. Ambient Temperature Power Derating

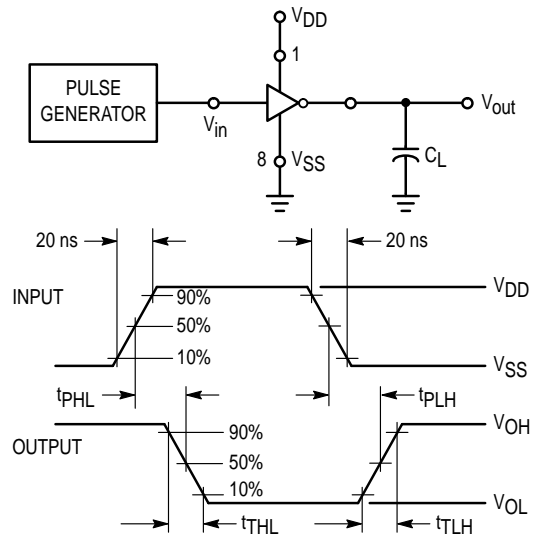

Figure 5. Switching Time Test Circuit and Waveforms

This device contains circuitry to protect the inputs against damage due to high static voltages or electric fields referenced to the V_{SS} pin, only. Extra precautions must be taken to avoid applications of any voltage higher than the maximum rated voltages to this high-impedance circuit. For proper operation, the ranges $V_{SS} \leq V_{in} \leq 18V$ and $V_{SS} \leq V_{out} \leq V_{DD}$ are recommended.

Unused inputs must always be tied to an appropriate logic voltage level (e.g., either V_{SS} or V_{DD}). Unused outputs must be left open.

PIN ASSIGNMENT

V_{DD}	1	16	NC
OUT _A	2	15	OUT _F
IN _A	3	14	IN _F
OUT _B	4	13	NC
IN _B	5	12	OUT _E
OUT _C	6	11	IN _E
IN _C	7	10	OUT _D
V_{SS}	8	9	IN _D

NC = NO CONNECTION

OUTLINE DIMENSIONS

L SUFFIX CERAMIC DIP PACKAGE CASE 620-10 ISSUE V

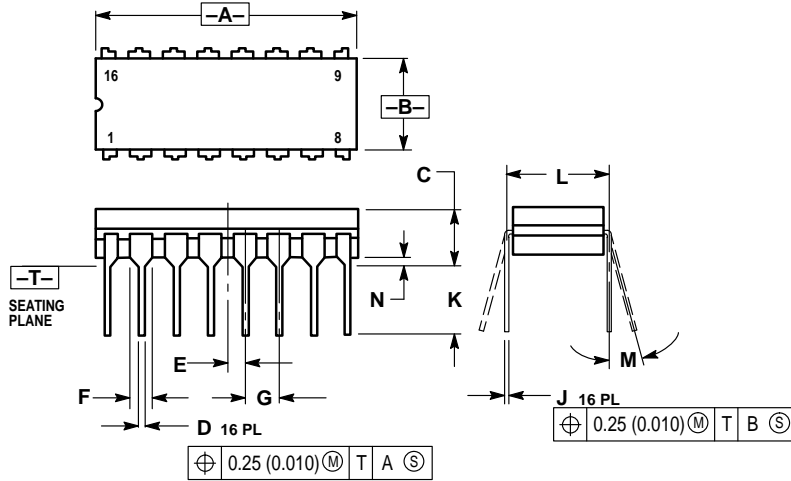

NOTES:

1. DIMENSIONING AND TOLERANCING PER ANSI Y14.5M, 1982.
2. CONTROLLING DIMENSION: INCH.
3. DIMENSION L TO CENTER OF LEAD WHEN FORMED PARALLEL.
4. DIMENSION F MAY NARROW TO 0.76 (0.030) WHERE THE LEAD ENTERS THE CERAMIC BODY.

DIM	INCHES		MILLIMETERS	
	MIN	MAX	MIN	MAX
A	0.750	0.785	19.05	19.93
B	0.240	0.295	6.10	7.49
C	—	0.200	—	5.08
D	0.015	0.020	0.39	0.50
E	0.050 BSC		1.27 BSC	
F	0.055	0.065	1.40	1.65
G	0.100 BSC		2.54 BSC	
H	0.008	0.015	0.21	0.38
K	0.125	0.170	3.18	4.31
L	0.300 BSC		7.62 BSC	
M	0°	15°	0°	15°
N	0.020	0.040	0.51	1.01

P SUFFIX PLASTIC DIP PACKAGE CASE 648-08 ISSUE R

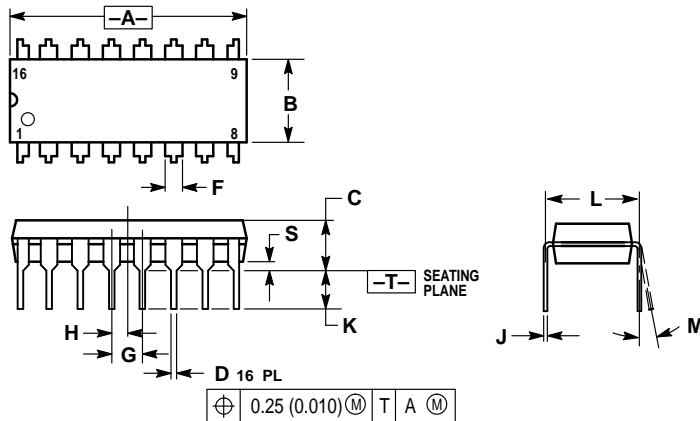

NOTES:

1. DIMENSIONING AND TOLERANCING PER ANSI Y14.5M, 1982.
2. CONTROLLING DIMENSION: INCH.
3. DIMENSION L TO CENTER OF LEADS WHEN FORMED PARALLEL.
4. DIMENSION B DOES NOT INCLUDE MOLD FLASH.
5. ROUNDED CORNERS OPTIONAL.

DIM	INCHES		MILLIMETERS	
	MIN	MAX	MIN	MAX
A	0.740	0.770	18.80	19.55
B	0.250	0.270	6.35	6.85
C	0.145	0.175	3.69	4.44
D	0.015	0.021	0.39	0.53
F	0.040	0.70	1.02	1.77
G	0.100 BSC		2.54 BSC	
H	0.050 BSC		1.27 BSC	
J	0.008	0.015	0.21	0.38
K	0.110	0.130	2.80	3.30
L	0.295	0.305	7.50	7.74
M	0°	10°	0°	10°
S	0.020	0.040	0.51	1.01

OUTLINE DIMENSIONS

D SUFFIX PLASTIC SOIC PACKAGE CASE 751B-05 ISSUE J

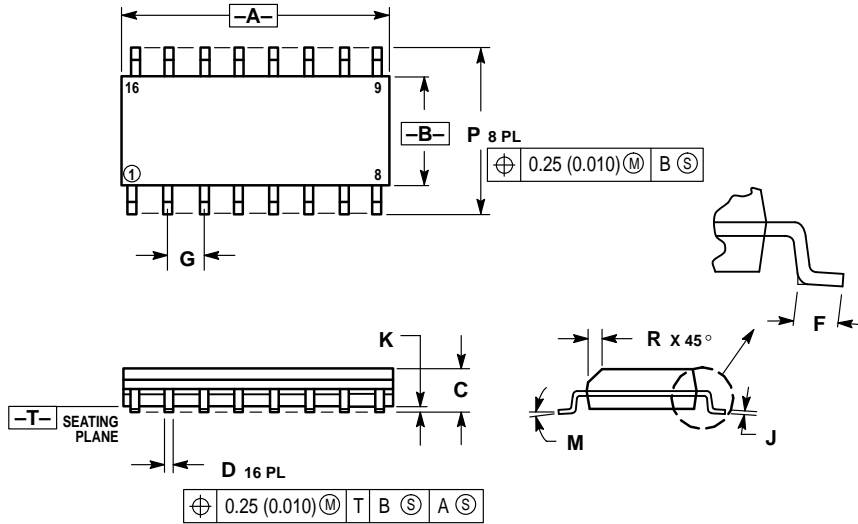

- NOTES:
1. DIMENSIONING AND TOLERANCING PER ANSI Y14.5M, 1982.
 2. CONTROLLING DIMENSION: MILLIMETER.
 3. DIMENSIONS A AND B DO NOT INCLUDE MOLD PROTRUSION.
 4. MAXIMUM MOLD PROTRUSION 0.15 (0.006) PER SIDE.
 5. DIMENSION D DOES NOT INCLUDE DAMBAR PROTRUSION. ALLOWABLE DAMBAR PROTRUSION SHALL BE 0.127 (0.005) TOTAL IN EXCESS OF THE D DIMENSION AT MAXIMUM MATERIAL CONDITION.

DIM	MILLIMETERS		INCHES	
	MIN	MAX	MIN	MAX
A	9.80	10.00	0.386	0.393
B	3.80	4.00	0.150	0.157
C	1.35	1.75	0.054	0.068
D	0.35	0.49	0.014	0.019
F	0.40	1.25	0.016	0.049
G	1.27 BSC		0.050 BSC	
J	0.19	0.25	0.008	0.009
K	0.10	0.25	0.004	0.009
M	0°	7°	0°	7°
P	5.80	6.20	0.229	0.244
R	0.25	0.50	0.010	0.019

Motorola reserves the right to make changes without further notice to any products herein. Motorola makes no warranty, representation or guarantee regarding the suitability of its products for any particular purpose, nor does Motorola assume any liability arising out of the application or use of any product or circuit, and specifically disclaims any and all liability, including without limitation consequential or incidental damages. "Typical" parameters which may be provided in Motorola data sheets and/or specifications can and do vary in different applications and actual performance may vary over time. All operating parameters, including "Typicals" must be validated for each customer application by customer's technical experts. Motorola does not convey any license under its patent rights nor the rights of others. Motorola products are not designed, intended, or authorized for use as components in systems intended for surgical implant into the body, or other applications intended to support or sustain life, or for any other application in which the failure of the Motorola product could create a situation where personal injury or death may occur. Should Buyer purchase or use Motorola products for any such unintended or unauthorized application, Buyer shall indemnify and hold Motorola and its officers, employees, subsidiaries, affiliates, and distributors harmless against all claims, costs, damages, and expenses, and reasonable attorney fees arising out of, directly or indirectly, any claim of personal injury or death associated with such unintended or unauthorized use, even if such claim alleges that Motorola was negligent regarding the design or manufacture of the part. Motorola and are registered trademarks of Motorola, Inc. Motorola, Inc. is an Equal Opportunity/Affirmative Action Employer.

How to reach us:
USA/EUROPE/Locations Not Listed: Motorola Literature Distribution;
P.O. Box 20912; Phoenix, Arizona 85036. 1-800-441-2447 or 602-303-5454

JAPAN: Nippon Motorola Ltd.; Tatsumi-SPD-JLDC, 6F Seibu-Butsuryu-Center,
3-14-2 Tatsumi Koto-Ku, Tokyo 135, Japan. 03-81-3521-8315

MFAX: RMFAX0@email.sps.mot.com - TOUCHTONE 602-244-6609
INTERNET: http://Design-NET.com

ASIA/PACIFIC: Motorola Semiconductors H.K. Ltd.; 8B Tai Ping Industrial Park,
51 Ting Kok Road, Tai Po, N.T., Hong Kong. 852-26629298



MC14049UB/D

