

**MJH10012**  
(See MJ10012)

# Complementary Darlington Silicon Power Transistors

... designed for use as general purpose amplifiers, low frequency switching and motor control applications.

- High DC Current Gain @ 10 Adc —  $h_{FE} = 400$  Min (All Types)
- Collector–Emitter Sustaining Voltage
  - $V_{CE(sus)} = 150$  Vdc (Min) — MJH11018, 17
  - $= 200$  Vdc (Min) — MJH11020, 19
  - $= 250$  Vdc (Min) — MJH11022, 21
- Low Collector–Emitter Saturation Voltage
  - $V_{CE(sat)} = 1.2$  V (Typ) @  $I_C = 5.0$  A
  - $= 1.8$  V (Typ) @  $I_C = 10$  A
- Monolithic Construction

**PNP**  
**MJH11017\***  
**MJH11019\***  
**MJH11021\***  
**NPN**  
**MJH11018\***  
**MJH11020\***  
**MJH11022\***

\*Motorola Preferred Device

**15 AMPERE  
DARLINGTON  
COMPLEMENTARY SILICON  
POWER TRANSISTORS  
150, 200, 250 VOLTS  
150 WATTS**

## MAXIMUM RATINGS

| Rating   | Symbol         | MJH            |                |                | Unit                         |
|--|----------------|----------------|----------------|----------------|------------------------------|
|  |                | 11018<br>11017 | 11020<br>11019 | 11022<br>11021 |                              |
| Collector–Emitter Voltage  | $V_{CEO}$      | 150            | 200            | 250            | Vdc                          |
| Collector–Base Voltage   | $V_{CB}$       | 150            | 200            | 250            | Vdc                          |
| Emitter–Base Voltage   | $V_{EB}$       | 5.0            |                |                | Vdc                          |
| Collector Current — Continuous<br>— Peak (1)   | $I_C$          | 15<br>30       |                |                | Adc                          |
| Base Current   | $I_B$          | 0.5            |                |                | Adc                          |
| Total Device Dissipation @ $T_C = 25^\circ\text{C}$<br>Derate Above $25^\circ\text{C}$ | $P_D$          | 150<br>1.2     |                |                | Watts<br>W/ $^\circ\text{C}$ |
| Operating and Storage Junction<br>Temperature Range                                    | $T_J, T_{stg}$ | –65 to +150    |                |                | $^\circ\text{C}$             |

## THERMAL CHARACTERISTICS

| Characteristic                       | Symbol          | Max  | Unit                      |
|--------------------------------------|-----------------|------|---------------------------|
| Thermal Resistance, Junction to Case | $R_{\theta JC}$ | 0.83 | $^\circ\text{C}/\text{W}$ |

(1) Pulse Test: Pulse Width = 5.0 ms, Duty Cycle  $\leq 10\%$ .

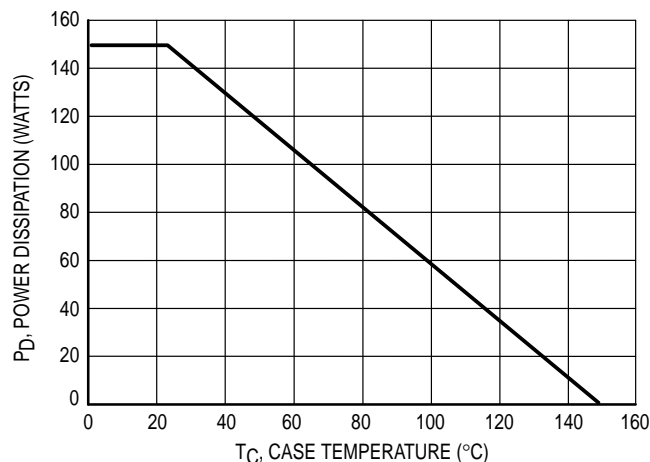
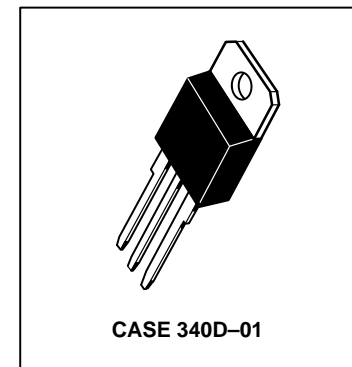

Figure 1. Power Derating



Preferred devices are Motorola recommended choices for future use and best overall value.

**MJH11017 MJH11019 MJH11021 MJH11018 MJH11020 MJH11022**

**ELECTRICAL CHARACTERISTICS** ( $T_C = 25^\circ\text{C}$  unless otherwise noted)

| Characteristic   | Symbol         | Min               | Max               | Unit |
|--|----------------|-------------------|-------------------|------|
| <b>OFF CHARACTERISTICS</b>   |                |                   |                   |      |
| Collector–Emitter Sustaining Voltage (1)<br>( $I_C = 0.1\text{ A dc}$ , $I_B = 0$ )  | $V_{CEO(sus)}$ | 150<br>200<br>250 | —                 | Vdc  |
| Collector Cutoff Current<br>( $V_{CE} = 75\text{ Vdc}$ , $I_B = 0$ )<br>( $V_{CE} = 100\text{ Vdc}$ , $I_B = 0$ )<br>( $V_{CE} = 125\text{ Vdc}$ , $I_B = 0$ )                                       | $I_{CEO}$      | —<br>—<br>—       | 1.0<br>1.0<br>1.0 | mAdc |
| Collector Cutoff Current<br>( $V_{CE} = \text{Rated } V_{CB}$ , $V_{BE(off)} = 1.5\text{ Vdc}$ )<br>( $V_{CE} = \text{Rated } V_{CB}$ , $V_{BE(off)} = 1.5\text{ Vdc}$ , $T_J = 150^\circ\text{C}$ ) | $I_{CEV}$      | —<br>—            | 0.5<br>5.0        | mAdc |
| Emitter Cutoff Current ( $V_{BE} = 5.0\text{ Vdc}$ , $I_C = 0$ )   | $I_{EBO}$      | —                 | 2.0               | mAdc |

**ON CHARACTERISTICS (1)**

|   |               |            |             |     |
|---|---------------|------------|-------------|-----|
| DC Current Gain ( $I_C = 10\text{ A dc}$ , $V_{CE} = 5.0\text{ Vdc}$ )<br>( $I_C = 15\text{ A dc}$ , $V_{CE} = 5.0\text{ Vdc}$ )              | $h_{FE}$      | 400<br>100 | 15,000<br>— | —   |
| Collector–Emitter Saturation Voltage ( $I_C = 10\text{ A dc}$ , $I_B = 100\text{ mA}$ )<br>( $I_C = 15\text{ A dc}$ , $I_B = 150\text{ mA}$ ) | $V_{CE(sat)}$ | —<br>—     | 2.5<br>4.0  | Vdc |
| Base–Emitter On Voltage ( $I_C = 10\text{ A}$ , $V_{CE} = 5.0\text{ Vdc}$ )   | $V_{BE(on)}$  | —          | 2.8         | Vdc |
| Base–Emitter Saturation Voltage ( $I_C = 15\text{ A dc}$ , $I_B = 150\text{ mA}$ )  | $V_{BE(sat)}$ | —          | 3.8         | Vdc |

**DYNAMIC CHARACTERISTICS**

|   |          |        |            |    |
|---|----------|--------|------------|----|
| Current–Gain Bandwidth Product<br>( $I_C = 10\text{ A dc}$ , $V_{CE} = 3.0\text{ Vdc}$ , $f = 1.0\text{ MHz}$ ) | $f_T$    | 3.0    | —          | —  |
| Output Capacitance<br>( $V_{CB} = 10\text{ Vdc}$ , $I_E = 0$ , $f = 0.1\text{ MHz}$ )                           | $C_{ob}$ | —<br>— | 400<br>600 | pF |
| Small–Signal Current Gain ( $I_C = 10\text{ A dc}$ , $V_{CE} = 3.0\text{ Vdc}$ , $f = 1.0\text{ kHz}$ )         | $h_{fe}$ | 75     | —          | —  |

**SWITCHING CHARACTERISTICS**

| Characteristic | Symbol | Typical |     | Unit          |
|----------------|--------|---------|-----|---------------|
|                |        | NPN     | PNP |               |
| Delay Time     | $t_d$  | 150     | 75  | ns            |
| Rise Time      | $t_r$  | 1.2     | 0.5 | $\mu\text{s}$ |
| Storage Time   | $t_s$  | 4.4     | 2.7 | $\mu\text{s}$ |
| Fall Time      | $t_f$  | 2.5     | 2.5 | $\mu\text{s}$ |

(1) Pulse Test: Pulse Width = 300  $\mu\text{s}$ , Duty Cycle  $\leq 2.0\%$ .

$R_B$  &  $R_C$  varied to obtain desired current levels  
 $D_1$ , must be fast recovery types, e.g.:  
 1N5825 used above  $I_B \approx 100\text{ mA}$   
 MSD6100 used below  $I_B \approx 100\text{ mA}$

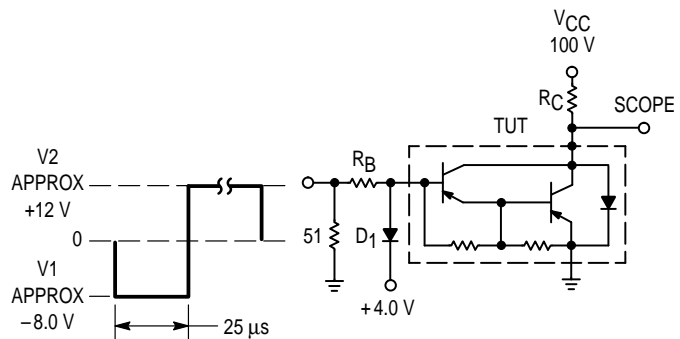

$t_r, t_f \leq 10\text{ ns}$   
 Duty Cycle = 1.0%

For  $t_d$  and  $t_r$ ,  $D_1$  is disconnected and  $V_2 = 0$

For NPN test circuit, reverse diode and voltage polarities.

**Figure 2. Switching Times Test Circuit**

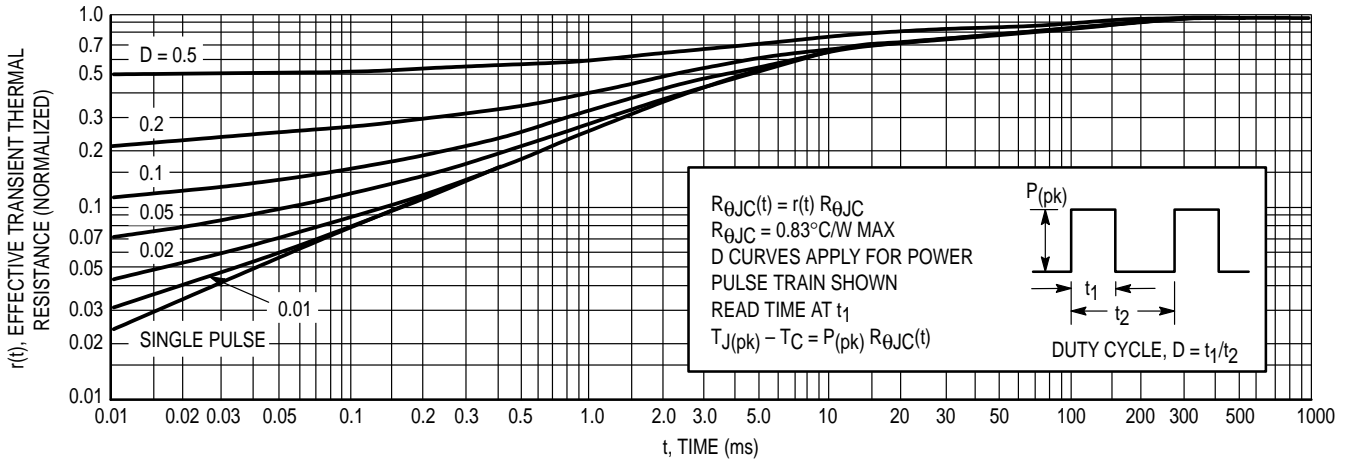

Figure 3. Thermal Response

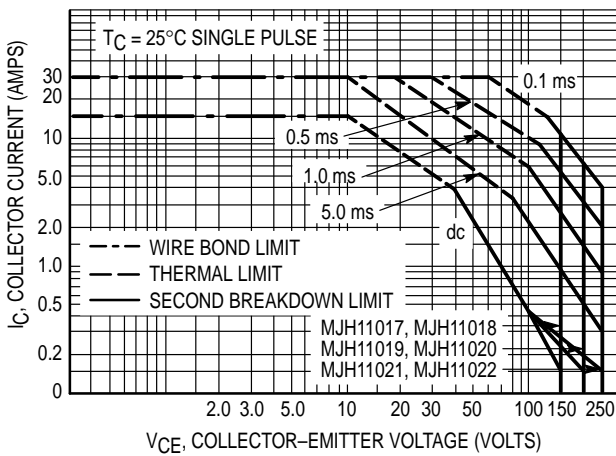

Figure 4. Maximum Rated Forward Bias Safe Operating Area (FBSOA)

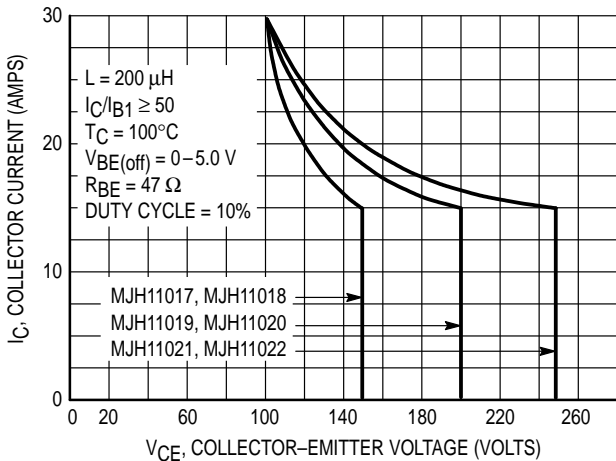

Figure 5. Maximum Rated Reverse Bias Safe Operating Area (RBSOA)

**FORWARD BIAS**

There are two limitations on the power handling ability of a transistor: average junction temperature and second breakdown. Safe operating area curves indicate  $I_C - V_{CE}$  limits of the transistor that must be observed for reliable operation; i.e., the transistor must not be subjected to greater dissipation than the curves indicate.

The data of Figure 4 is based on  $T_J(\text{pk}) = 150^{\circ}\text{C}$ ;  $T_C$  is variable depending on conditions. Second breakdown pulse limits are valid for duty cycles to 10% provided  $T_J(\text{pk}) \leq 150^{\circ}\text{C}$ .  $T_J(\text{pk})$  may be calculated from the data in Figure 3. At high case temperatures, thermal limitations will reduce the power that can be handled to values less than the limitations imposed by second breakdown.

**REVERSE BIAS**

For inductive loads, high voltage and high current must be sustained simultaneously during turn-off, in most cases, with the base to emitter junction reverse biased. Under these conditions the collector voltage must be held to a safe level at or below a specific value of collector current. This can be accomplished by several means such as active clamping, RC snubbing, load line shaping, etc. The safe level for these devices is specified as Reverse Bias Safe Operating Area and represents the voltage-current conditions during reverse biased turn-off. This rating is verified under clamped conditions so that the device is never subjected to an avalanche mode. Figure 5 gives RBSOA characteristics.

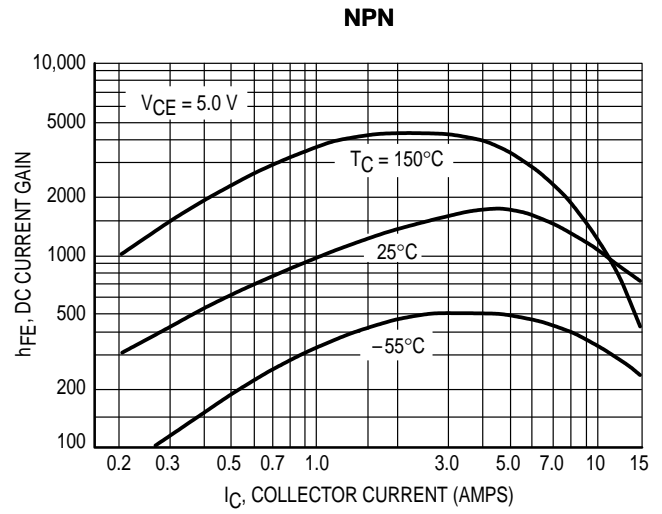
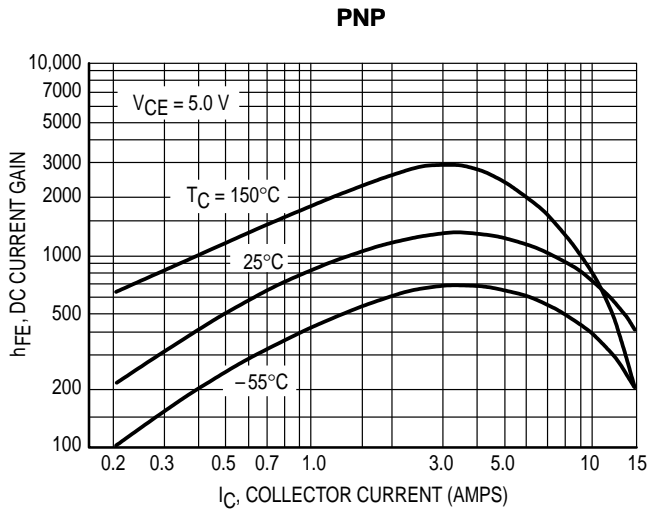

Figure 6. DC Current Gain

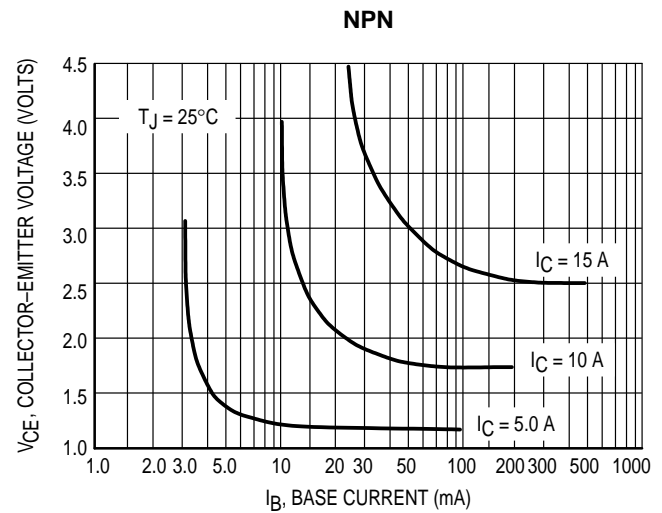
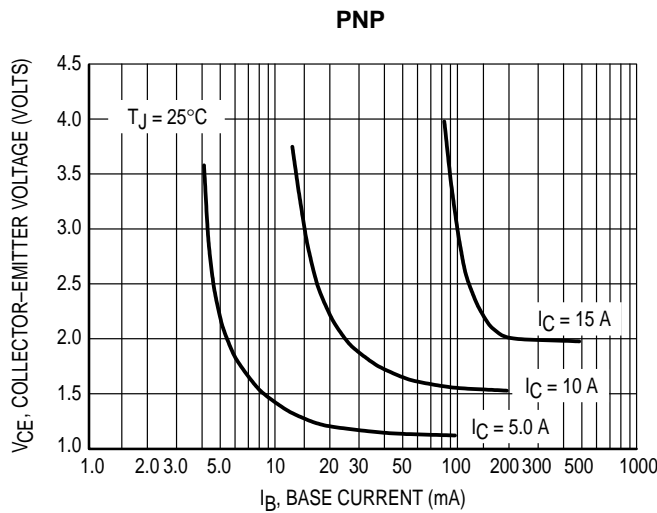

Figure 7. Collector Saturation Region

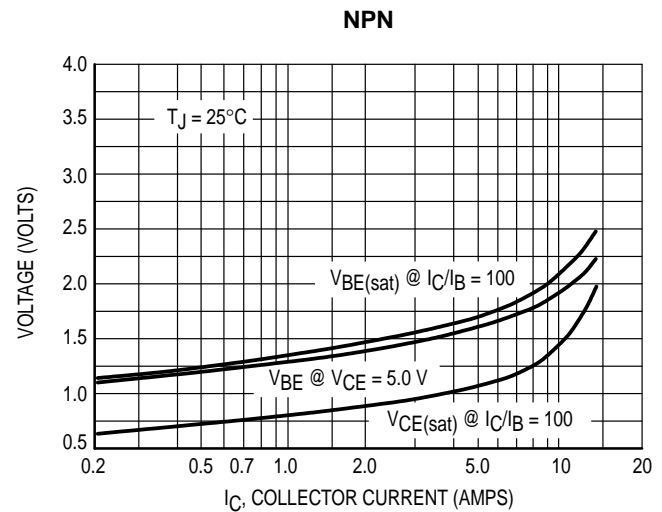
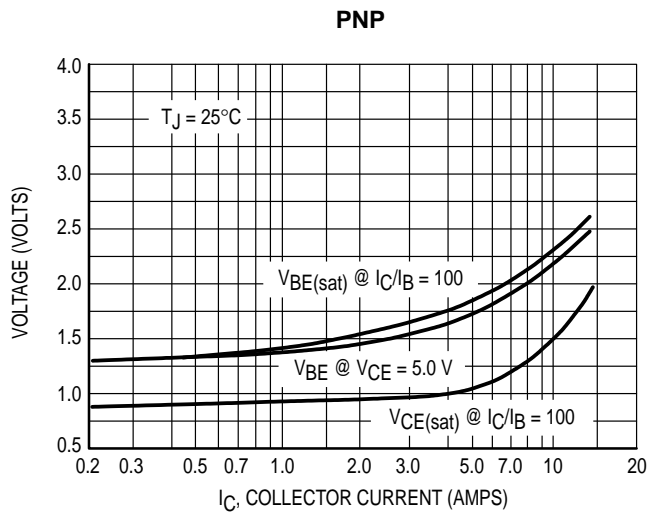

Figure 8. "On" Voltages

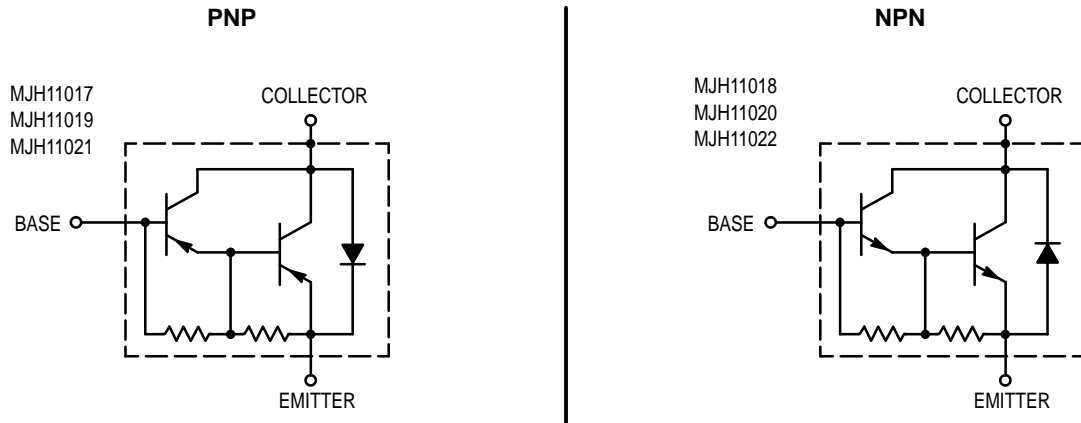
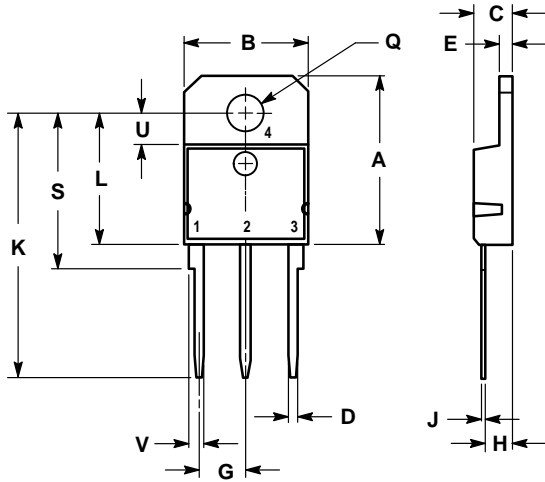

Figure 9. Darlington Schematic

PACKAGE DIMENSIONS



NOTES:  
 1. DIMENSIONING AND TOLERANCING PER ANSI Y14.5M, 1982.  
 2. CONTROLLING DIMENSION: MILLIMETER.

| DIM | MILLIMETERS |       | INCHES |       |
|-----|-------------|-------|--------|-------|
|     | MIN         | MAX   | MIN    | MAX   |
| A   | 19.00       | 19.60 | 0.749  | 0.771 |
| B   | 14.00       | 14.50 | 0.551  | 0.570 |
| C   | 4.20        | 4.70  | 0.165  | 0.185 |
| D   | 1.00        | 1.30  | 0.040  | 0.051 |
| E   | 1.45        | 1.65  | 0.058  | 0.064 |
| G   | 5.21        | 5.72  | 0.206  | 0.225 |
| H   | 2.60        | 3.00  | 0.103  | 0.118 |
| J   | 0.40        | 0.60  | 0.016  | 0.023 |
| K   | 28.50       | 32.00 | 1.123  | 1.259 |
| L   | 14.70       | 15.30 | 0.579  | 0.602 |
| Q   | 4.00        | 4.25  | 0.158  | 0.167 |
| S   | 17.50       | 18.10 | 0.689  | 0.712 |
| U   | 3.40        | 3.80  | 0.134  | 0.149 |
| V   | 1.50        | 2.00  | 0.060  | 0.078 |

STYLE 1:  
 PIN 1: BASE  
 2. COLLECTOR  
 3. EMITTER  
 4. COLLECTOR

**CASE 340D-01**  
**SOT 93, TO-218 TYPE**  
**ISSUE A**

Motorola reserves the right to make changes without further notice to any products herein. Motorola makes no warranty, representation or guarantee regarding the suitability of its products for any particular purpose, nor does Motorola assume any liability arising out of the application or use of any product or circuit, and specifically disclaims any and all liability, including without limitation consequential or incidental damages. "Typical" parameters can and do vary in different applications. All operating parameters, including "Typicals" must be validated for each customer application by customer's technical experts. Motorola does not convey any license under its patent rights nor the rights of others. Motorola products are not designed, intended, or authorized for use as components in systems intended for surgical implant into the body, or other applications intended to support or sustain life, or for any other application in which the failure of the Motorola product could create a situation where personal injury or death may occur. Should Buyer purchase or use Motorola products for any such unintended or unauthorized application, Buyer shall indemnify and hold Motorola and its officers, employees, subsidiaries, affiliates, and distributors harmless against all claims, costs, damages, and expenses, and reasonable attorney fees arising out of, directly or indirectly, any claim of personal injury or death associated with such unintended or unauthorized use, even if such claim alleges that Motorola was negligent regarding the design or manufacture of the part. Motorola and are registered trademarks of Motorola, Inc. Motorola, Inc. is an Equal Opportunity/Affirmative Action Employer.

**How to reach us:**  
**USA/EUROPE:** Motorola Literature Distribution;  
 P.O. Box 20912; Phoenix, Arizona 85036. 1-800-441-2447

**JAPAN:** Nippon Motorola Ltd.; Tatsumi-SPD-JLDC, Toshikatsu Otsuki,  
 6F Seibu-Butsuryu-Center, 3-14-2 Tatsumi Koto-Ku, Tokyo 135, Japan. 03-3521-8315

**MFAX:** RMFAX0@email.sps.mot.com - TOUCHTONE (602) 244-6609  
**INTERNET:** http://Design-NET.com

**HONG KONG:** Motorola Semiconductors H.K. Ltd.; 8B Tai Ping Industrial Park,  
 51 Ting Kok Road, Tai Po, N.T., Hong Kong. 852-26629298

