

VHF Transistor

NPN Silicon

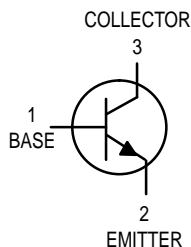

MPSH24

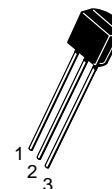

CASE 29-04, STYLE 2
TO-92 (TO-226AA)

MAXIMUM RATINGS

Rating	Symbol	Value	Unit
Collector–Emitter Voltage	V_{CEO}	30	Vdc
Collector–Base Voltage	V_{CBO}	40	Vdc
Emitter–Base Voltage	V_{EBO}	4.0	Vdc
Collector Current – Continuous	I_C	50	mAdc
Total Device Dissipation @ $T_A = 25^\circ\text{C}$ Derate above 25°C	P_D	350 2.8	mW mW/ $^\circ\text{C}$
Operating and Storage Junction Temperature Range	T_J, T_{stg}	-55 to +135	$^\circ\text{C}$

THERMAL CHARACTERISTICS

Characteristic	Symbol	Max	Unit
Thermal Resistance, Junction to Ambient	$R_{\theta JA}$	357	$^\circ\text{C}/\text{W}$

ELECTRICAL CHARACTERISTICS ($T_A = 25^\circ\text{C}$ unless otherwise noted)

Characteristic	Symbol	Min	Typ	Max	Unit
----------------	--------	-----	-----	-----	------

OFF CHARACTERISTICS

Collector–Emitter Breakdown Voltage ($I_C = 1.0 \text{ mAdc}, I_E = 0$)	$V_{(BR)CEO}$	30	—	—	Vdc
Collector–Base Breakdown Voltage ($I_C = 100 \mu\text{Adc}, I_E = 0$)	$V_{(BR)CBO}$	40	—	—	Vdc
Emitter–Base Breakdown Voltage ($I_E = 10 \mu\text{Adc}, I_C = 0$)	$V_{(BR)EBO}$	4.0	—	—	Vdc
Collector Cutoff Current ($V_{CB} = 15 \text{ Vdc}, I_E = 0$)	I_{CBO}	—	—	50	nAdc

ON CHARACTERISTICS

DC Current Gain ($I_C = 8.0 \text{ mAdc}, V_{CE} = 10 \text{ Vdc}$)	h_{FE}	30	—	—	—
--	----------	----	---	---	---

SMALL-SIGNAL CHARACTERISTICS

Current–Gain — Bandwidth Product ($I_C = 8.0 \text{ mAdc}, V_{CE} = 10 \text{ Vdc}, f = 100 \text{ MHz}$)	f_T	400	620	—	MHz
Collector–Base Capacitance ($V_{CB} = 10 \text{ Vdc}, I_E = 0, f = 1.0 \text{ MHz}$)	C_{cb}	—	0.25	0.36	pF
Conversion Gain (213 MHz to 45 MHz) ($I_C = 8.0 \text{ mAdc}, V_{CC} = 20 \text{ Vdc}, \text{Oscillator Injection} = 150 \text{ mVrms}$) (60 MHz to 45 MHz) ($I_C = 8.0 \text{ mAdc}, V_{CC} = 20 \text{ Vdc}, \text{Oscillator Injection} = 150 \text{ mVrms}$)	G_C	19 24	24 29	—	dB

CONVERSION GAIN CHARACTERISTICS

(TEST CIRCUIT FIGURE 7)

($V_{CC} = 20$ Vdc, $R_S = R_L = 50$ Ohms, $f_{if} = 44$ MHz, B.W. = 6.0 MHz)

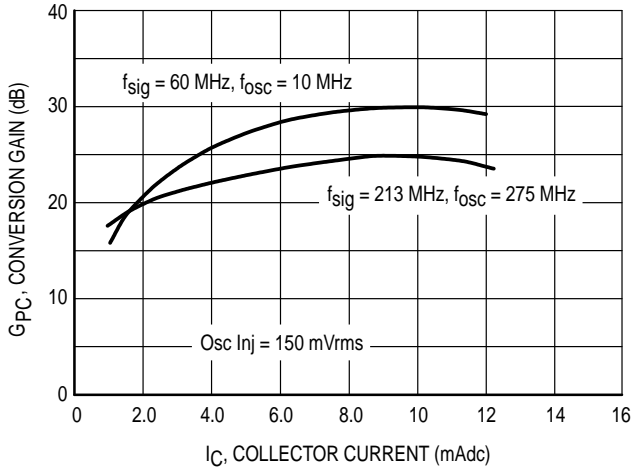

Figure 1. Conversion Gain versus Collector Current

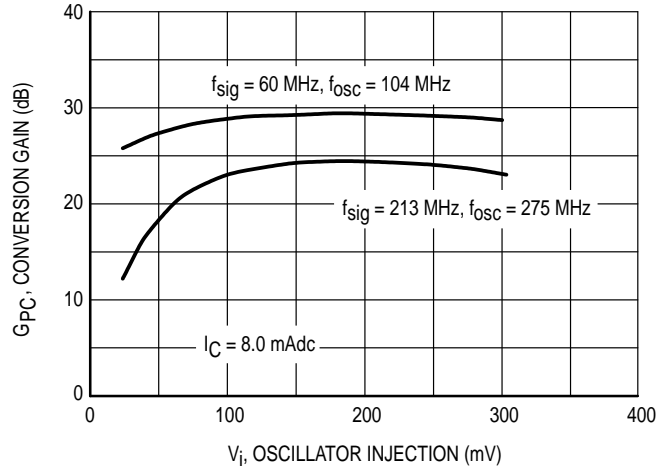

Figure 2. Conversion Gain versus Injection Level

COMMON-EMITTER y PARAMETERS

($V_{CE} = 15$ Vdc, $T_A = 25^\circ\text{C}$)

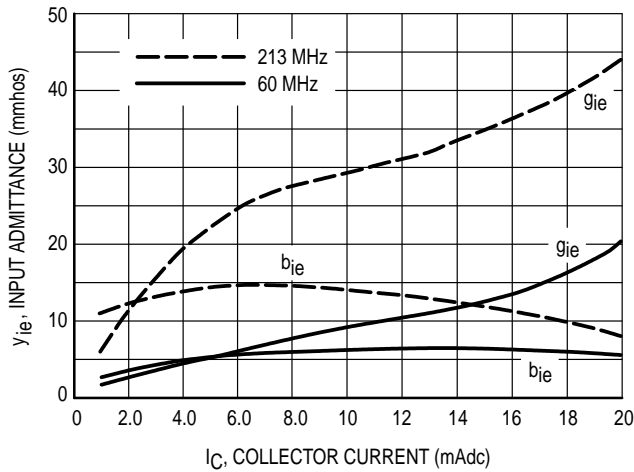

Figure 3. Input Admittance

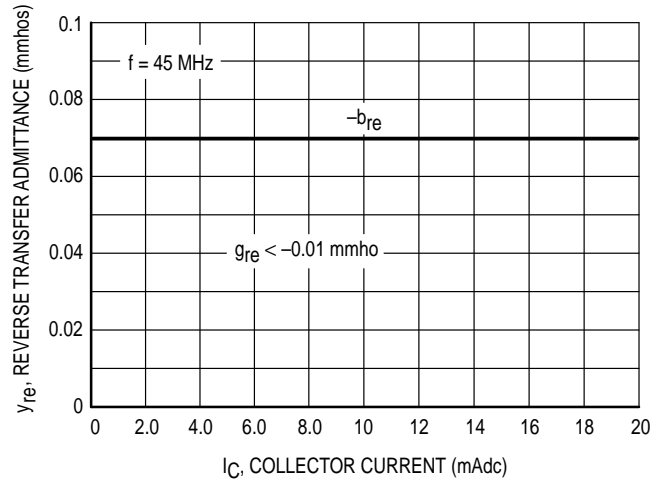

Figure 4. Reverse Transfer Admittance

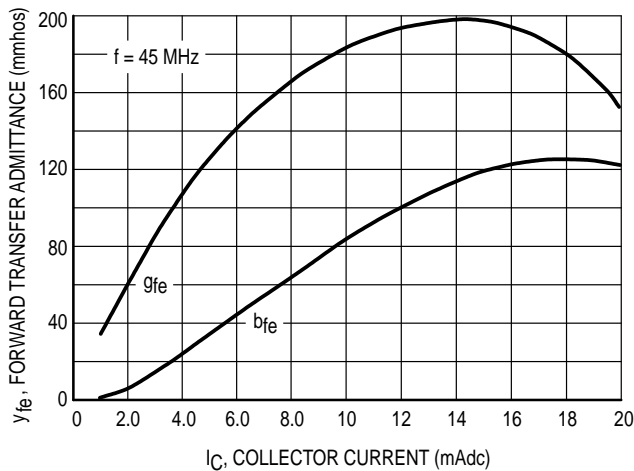

Figure 5. Forward Transfer Admittance

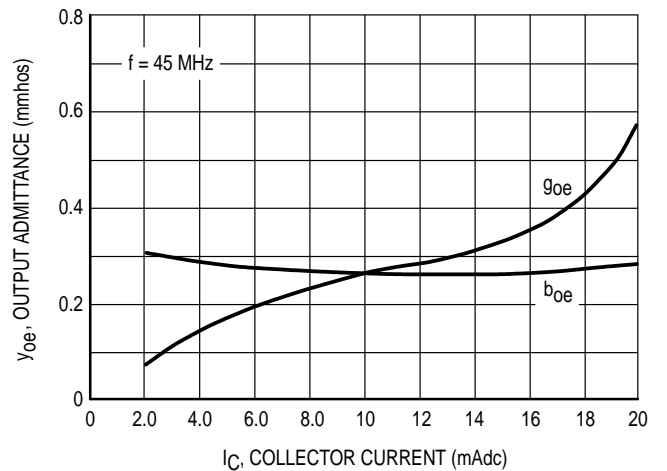

Figure 6. Output Admittance

f_{sig}	60 MHz	213 MHz
f_{osc}	105 MHz	258 MHz
C1	1.5–20 pF	1.5–20 pF
C2	8.0–60 pF	6.0–12 pF
C3	8.0–60 pF	1.5–20 pF
C4	3.0–35 pF	—
C5	1.5–20 pF	—
L1	5 Turns #26 Air, Tap 1 Turn	3 Turns #16 Air, Tap $\frac{1}{2}$ Turn
L2	10 Turns #26 Air	10 Turns #26 Arnold A1–10 Core
L3	Ohmite Z235	—

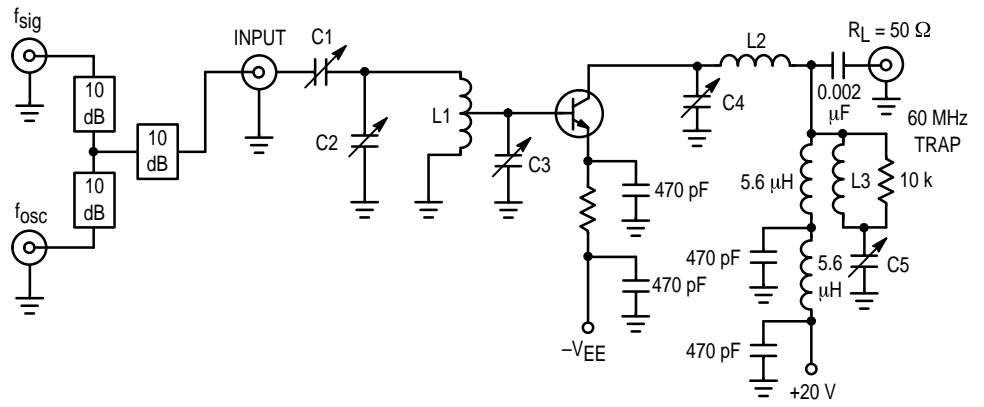
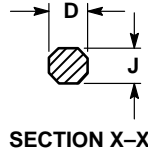
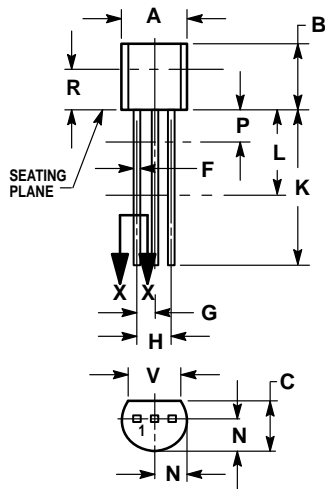

Figure 7. VHF Mixer Test Circuit
($f_{if} = 44$ MHz, B.W. = 6.0 MHz)

PACKAGE DIMENSIONS



CASE 029-04
(TO-226AA)
ISSUE AD

NOTES:

1. DIMENSIONING AND TOLERANCING PER ANSI Y14.5M, 1982.
2. CONTROLLING DIMENSION: INCH.
3. CONTOUR OF PACKAGE BEYOND DIMENSION R IS UNCONTROLLED.
4. DIMENSION F APPLIES BETWEEN P AND L. DIMENSION D AND J APPLY BETWEEN L AND K. MINIMUM LEAD DIMENSION IS UNCONTROLLED IN P AND BEYOND DIMENSION K MINIMUM.

DIM	INCHES		MILLIMETERS	
	MIN	MAX	MIN	MAX
A	0.175	0.205	4.45	5.20
B	0.170	0.210	4.32	5.33
C	0.125	0.165	3.18	4.19
D	0.016	0.022	0.41	0.55
F	0.016	0.019	0.41	0.48
G	0.045	0.055	1.15	1.39
H	0.095	0.105	2.42	2.66
J	0.015	0.020	0.39	0.50
K	0.500	—	12.70	—
L	0.250	—	6.35	—
N	0.080	0.105	2.04	2.66
P	—	0.100	—	2.54
R	0.115	—	2.93	—
V	0.135	—	3.43	—

STYLE 2:

- PIN 1. BASE
2. EMITTER
3. COLLECTOR

Motorola reserves the right to make changes without further notice to any products herein. Motorola makes no warranty, representation or guarantee regarding the suitability of its products for any particular purpose, nor does Motorola assume any liability arising out of the application or use of any product or circuit, and specifically disclaims any and all liability, including without limitation consequential or incidental damages. "Typical" parameters which may be provided in Motorola data sheets and/or specifications can and do vary in different applications and actual performance may vary over time. All operating parameters, including "Typicals" must be validated for each customer application by customer's technical experts. Motorola does not convey any license under its patent rights nor the rights of others. Motorola products are not designed, intended, or authorized for use as components in systems intended for surgical implant into the body, or other applications intended to support or sustain life, or for any other application in which the failure of the Motorola product could create a situation where personal injury or death may occur. Should Buyer purchase or use Motorola products for any such unintended or unauthorized application, Buyer shall indemnify and hold Motorola and its officers, employees, subsidiaries, affiliates, and distributors harmless against all claims, costs, damages, and expenses, and reasonable attorney fees arising out of, directly or indirectly, any claim of personal injury or death associated with such unintended or unauthorized use, even if such claim alleges that Motorola was negligent regarding the design or manufacture of the part. Motorola and (AA) are registered trademarks of Motorola, Inc. Motorola, Inc. is an Equal Opportunity/Affirmative Action Employer.

How to reach us:

USA/EUROPE/Locations Not Listed: Motorola Literature Distribution; P.O. Box 20912; Phoenix, Arizona 85036. 1-800-441-2447 or 602-303-5454

JAPAN: Nippon Motorola Ltd.; Tatsumi-SPD-JLDC, 6F Seibu-Butsuryu-Center, 3-14-2 Tatsumi Koto-Ku, Tokyo 135, Japan. 03-81-3521-8315

MFAX: RMFAX0@email.sps.mot.com - TOUCHTONE 602-244-6609
INTERNET: http://Design-NET.com

ASIA/PACIFIC: Motorola Semiconductors H.K. Ltd.; 8B Tai Ping Industrial Park, 51 Ting Kok Road, Tai Po, N.T., Hong Kong. 852-26629298

