

Dual Channel Small Outline Optoisolators Darlington Output

The MOC223 device consists of two gallium arsenide infrared emitting diodes optically coupled to two monolithic silicon phototransistor darlington detectors, in a surface mountable, small outline, plastic package. It is ideally suited for high density applications that require low input current and eliminates the need for through-the-board mounting.

- Dual Channel Coupler
- Convenient Plastic SOIC-8 Surface Mountable Package Style
- High Output Current (I_C) (500% min) @ 1 mA Input Current
- Minimum $V_{(BR)CEO}$ of 30 Volts Guaranteed
- Standard SOIC-8 Footprint, with 0.050" Lead Spacing
- Shipped in Tape and Reel, which conforms to EIA Standard RS481A
- Compatible with Dual Wave, Vapor Phase and IR Reflow Soldering
- High Input-Output Isolation of 3000 Vac (rms) Guaranteed
- Meets U.L. Regulatory Requirements, File #E54915

Ordering Information:

- To obtain MOC223 in tape and reel, add R2 suffix to device number as follows:
R2 = 2500 units on 13" reel
- To obtain MOC223 in quantities of 50 (shipped in sleeves) — no suffix

Marking Information:

- MOC223 = D223

MAXIMUM RATINGS ($T_A = 25^\circ\text{C}$ unless otherwise noted)

Rating	Symbol	Value	Unit
INPUT LED			
Forward Current — Continuous	I_F	60	mA
Forward Current — Peak (PW = 100 μs , 120 pps)	$I_F(pk)$	1.0	A
Reverse Voltage	V_R	6.0	V
LED Power Dissipation @ $T_A = 25^\circ\text{C}$ Derate above 25°C	P_D	90 0.8	mW mW/ $^\circ\text{C}$
OUTPUT DARLINGTON			
Collector-Emitter Voltage	V_{CEO}	30	V
Collector-Base Voltage	V_{CBO}	70	V
Emitter-Collector Voltage	V_{ECO}	7.0	V
Collector Current — Continuous	I_C	150	mA
Detector Power Dissipation @ $T_A = 25^\circ\text{C}$ Derate above 25°C	P_D	150 1.76	mW mW/ $^\circ\text{C}$

NOTE: Thickness through insulation between input and output is ≥ 0.5 mm.

MOC223

[CTR = 500% Min]

Motorola Preferred Device

**DUAL CHANNEL
SMALL OUTLINE
OPTOISOLATOR
DARLINGTON OUTPUT**

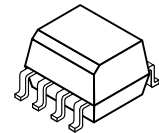

**CASE 846-01, STYLE 3
PLASTIC**

SCHEMATIC

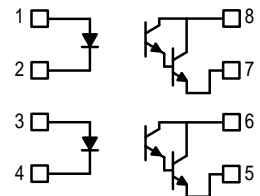

1. LED 1 ANODE
2. LED 1 CATHODE
3. LED 2 ANODE
4. LED 2 CATHODE
5. EMITTER 2
6. COLLECTOR 2
7. EMITTER 1
8. COLLECTOR 1

Preferred devices are Motorola recommended choices for future use and best overall value.

MOCD223

MAXIMUM RATINGS — continued ($T_A = 25^\circ\text{C}$ unless otherwise noted)

Rating	Symbol	Value	Unit
TOTAL DEVICE			
Input–Output Isolation Voltage ^(1,2) (60 Hz, 1.0 sec. duration)	V_{ISO}	3000	Vac(rms)
Total Device Power Dissipation @ $T_A = 25^\circ\text{C}$ Derate above 25°C	P_D	250 2.94	mW mW/ $^\circ\text{C}$
Ambient Operating Temperature Range ⁽³⁾	T_A	–55 to +100	$^\circ\text{C}$
Storage Temperature Range ⁽³⁾	T_{stg}	–55 to +150	$^\circ\text{C}$
Lead Soldering Temperature (1/16" from case, 10 sec. duration)	—	260	$^\circ\text{C}$

ELECTRICAL CHARACTERISTICS ($T_A = 25^\circ\text{C}$ unless otherwise noted)⁽⁴⁾

Characteristic	Symbol	Min	Typ ⁽⁴⁾	Max	Unit
----------------	--------	-----	--------------------	-----	------

INPUT LED

Forward Voltage ($I_F = 1.0\text{ mA}$)	V_F	—	1.05	1.3	V
Reverse Leakage Current ($V_R = 6.0\text{ V}$)	I_R	—	0.1	100	μA
Capacitance	C	—	18	—	pF

OUTPUT DARLINGTON

Collector–Emitter Dark Current	$(V_{CE} = 5.0\text{ V}, T_A = 25^\circ\text{C})$	I_{CEO1}	—	1.0	50	nA
	$(V_{CE} = 5.0\text{ V}, T_A = 100^\circ\text{C})$	I_{CEO2}	—	1.0	—	μA
Collector–Emitter Breakdown Voltage ($I_C = 100\ \mu\text{A}$)	$V_{(BR)CEO}$	30	90	—	V	
Emitter–Collector Breakdown Voltage ($I_E = 100\ \mu\text{A}$)	$V_{(BR)ECO}$	7.0	7.8	—	V	
Collector–Emitter Capacitance ($f = 1.0\text{ MHz}, V_{CE} = 0$)	C_{CE}	—	5.5	—	pF	

COUPLED

Output Collector Current ($I_F = 1.0\text{ mA}, V_{CE} = 5.0\text{ V}$)	MOCD223	I_C (CTR) ⁽⁵⁾	5.0 (500)	10 (1000)	—	mA (%)
Collector–Emitter Saturation Voltage ($I_C = 500\ \mu\text{A}, I_F = 1.0\text{ mA}$)		$V_{CE(sat)}$	—	—	1.0	V
Turn–On Time ($I_F = 5.0\text{ mA}, V_{CC} = 10\text{ V}, R_L = 100\ \Omega$)		t_{on}	—	3.5	—	μs
Turn–Off Time ($I_F = 5.0\text{ mA}, V_{CC} = 10\text{ V}, R_L = 100\ \Omega$)		t_{off}	—	95	—	μs
Rise Time ($I_F = 5.0\text{ mA}, V_{CC} = 10\text{ V}, R_L = 100\ \Omega$)		t_r	—	1.0	—	μs
Fall Time ($I_F = 5.0\text{ mA}, V_{CC} = 10\text{ V}, R_L = 100\ \Omega$)		t_f	—	2.0	—	μs
Input–Output Isolation Voltage ($f = 60\text{ Hz}, t = 1.0\text{ sec.}$) ^(1,2)		V_{ISO}	3000	—	—	Vac(rms)
Isolation Resistance ($V_{I-O} = 500\text{ V}$) ⁽²⁾		R_{ISO}	10^{11}	—	—	Ω
Isolation Capacitance ($V_{I-O} = 0, f = 1.0\text{ MHz}$) ⁽²⁾		C_{ISO}	—	0.2	—	pF

1. Input–Output Isolation Voltage, V_{ISO} , is an internal device dielectric breakdown rating.
2. For this test, pins 1, 2, 3 and 4 are common, and pins 5, 6, 7 and 8 are common.
3. Refer to Quality and Reliability Section in Opto Data Book for information on test conditions.
4. Always design to the specified minimum/maximum electrical limits (where applicable).
5. Current Transfer Ratio (CTR) = $I_C/I_F \times 100\%$.

TYPICAL CHARACTERISTICS

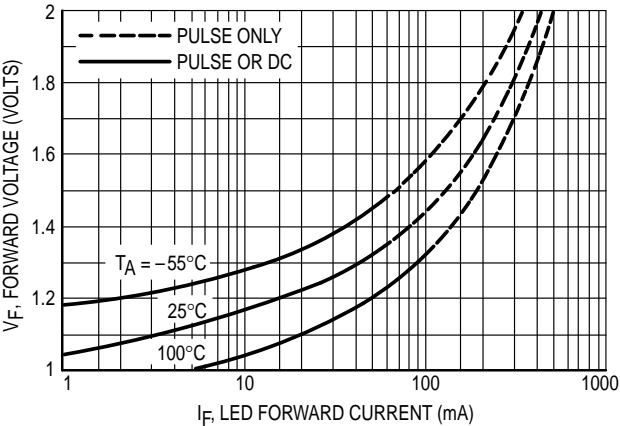

Figure 1. LED Forward Voltage versus Forward Current

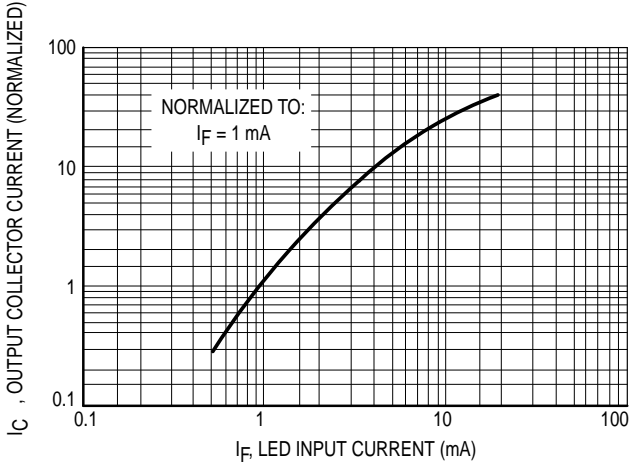

Figure 2. Output Current versus Input Current

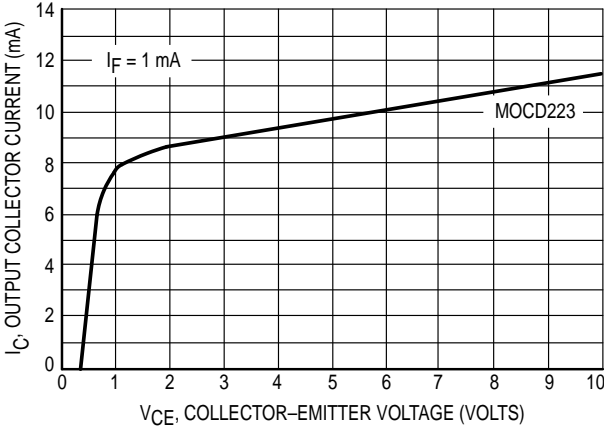

Figure 3. Output Current versus Collector-Emitter Voltage

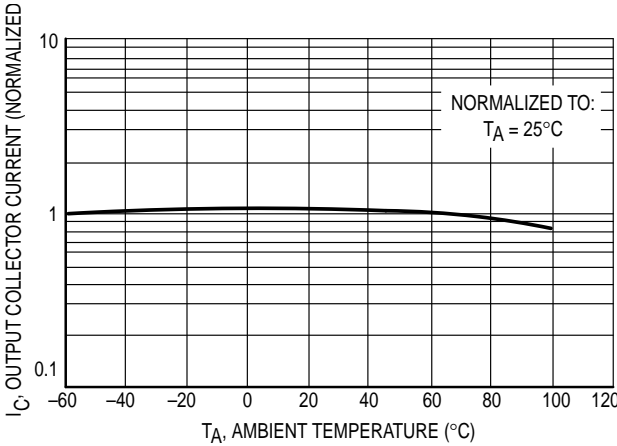

Figure 4. Output Current versus Ambient Temperature

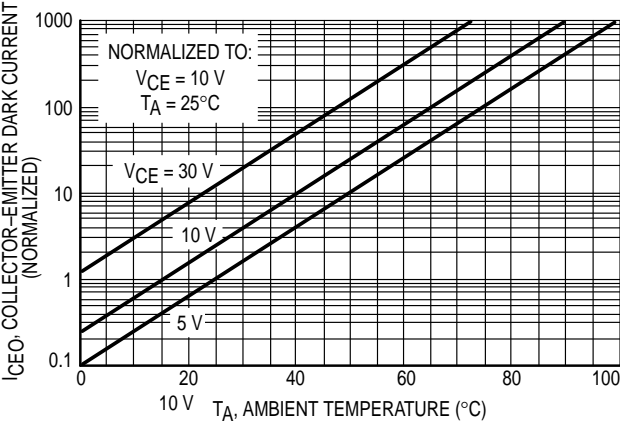

Figure 5. Dark Current versus Ambient Temperature

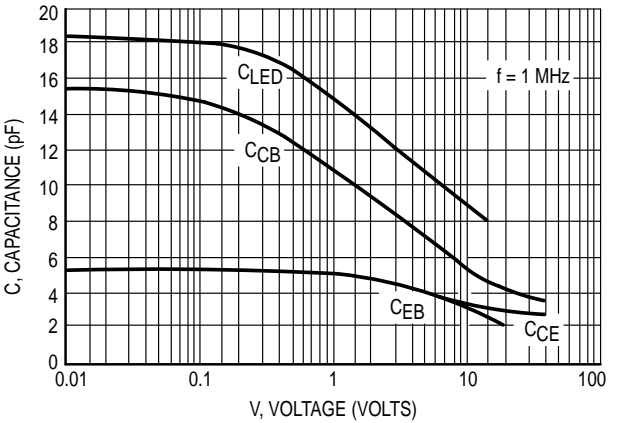
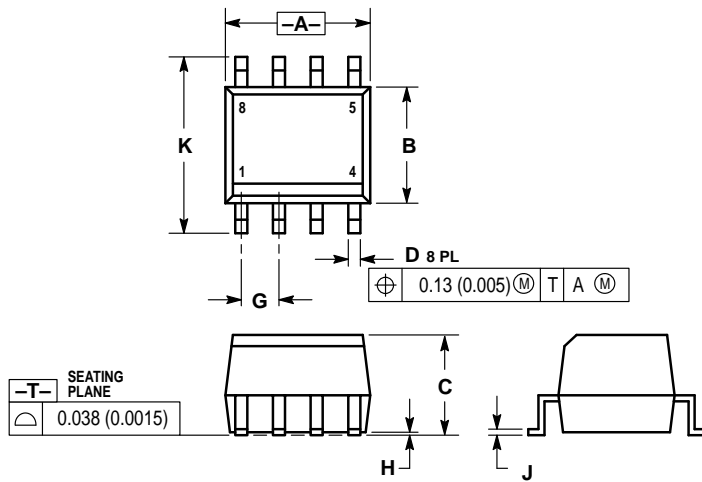

Figure 6. Capacitance versus Voltage

MOCD223

PACKAGE DIMENSIONS



- NOTES:
1. DIMENSIONING AND TOLERANCING PER ANSI Y14.5M, 1982.
 2. CONTROLLING DIMENSION: INCH.

DIM	INCHES		MILLIMETERS	
	MIN	MAX	MIN	MAX
A	0.182	0.202	4.63	5.13
B	0.144	0.164	3.66	4.16
C	0.123	0.143	3.13	3.63
D	0.011	0.021	0.28	0.53
G	0.050 BSC		1.27 BSC	
H	0.003	0.008	0.08	0.20
J	0.006	0.010	0.16	0.25
K	0.224	0.244	5.69	6.19

- STYLE 3:
- PIN 1. ANODE 1
 2. CATHODE 1
 3. ANODE 2
 4. CATHODE 2
 5. EMITTER 2
 6. COLLECTOR 2
 7. EMITTER 1
 8. COLLECTOR 1

CASE 846-01 ISSUE B

Motorola reserves the right to make changes without further notice to any products herein. Motorola makes no warranty, representation or guarantee regarding the suitability of its products for any particular purpose, nor does Motorola assume any liability arising out of the application or use of any product or circuit, and specifically disclaims any and all liability, including without limitation consequential or incidental damages. "Typical" parameters can and do vary in different applications. All operating parameters, including "Typicals" must be validated for each customer application by customer's technical experts. Motorola does not convey any license under its patent rights nor the rights of others. Motorola products are not designed, intended, or authorized for use as components in systems intended for surgical implant into the body, or other applications intended to support or sustain life, or for any other application in which the failure of the Motorola product could create a situation where personal injury or death may occur. Should Buyer purchase or use Motorola products for any such unintended or unauthorized application, Buyer shall indemnify and hold Motorola and its officers, employees, subsidiaries, affiliates, and distributors harmless against all claims, costs, damages, and expenses, and reasonable attorney fees arising out of, directly or indirectly, any claim of personal injury or death associated with such unintended or unauthorized use, even if such claim alleges that Motorola was negligent regarding the design or manufacture of the part. Motorola and are registered trademarks of Motorola, Inc. Motorola, Inc. is an Equal Opportunity/Affirmative Action Employer.

How to reach us:

USA / EUROPE: Motorola Literature Distribution;
P.O. Box 20912; Phoenix, Arizona 85036. 1-800-441-2447

JAPAN: Nippon Motorola Ltd.; Tatsumi-SPD-JLDC, Toshikatsu Otsuki,
6F Seibu-Butsuryu-Center, 3-14-2 Tatsumi Koto-Ku, Tokyo 135, Japan. 03-3521-8315

MFAX: RMFAX0@email.sps.mot.com - TOUCHTONE (602) 244-6609
INTERNET: <http://Design-NET.com>

HONG KONG: Motorola Semiconductors H.K. Ltd.; 8B Tai Ping Industrial Park,
51 Ting Kok Road, Tai Po, N.T., Hong Kong. 852-26629298



MOCD223/D

