

The RF Line NPN Silicon RF Power Transistor

Designed primarily for wideband large-signal output and driver amplifier stages in the 400 to 512 MHz frequency range.

- Specified 28 Volt, 470 MHz Characteristics
 - Output Power = 80 Watts
 - Minimum Gain = 7.3 dB
 - Efficiency = 50% (Min)
- Built-In Matching Network for Broadband Operation
- 100% Tested for Load Mismatch at all Phase Angles with 30:1 VSWR
- Gold Metallization System for High Reliability Applications

MRF338

**80 W, 400 to 512 MHz
CONTROLLED "Q"
BROADBAND RF POWER
TRANSISTOR
NPN SILICON**

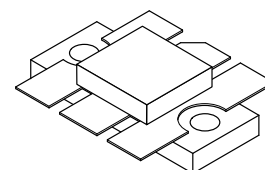

CASE 333-04, STYLE 1

MAXIMUM RATINGS

Rating	Symbol	Value	Unit
Collector-Emitter Voltage	V_{CEO}	30	Vdc
Collector-Base Voltage	V_{CBO}	60	Vdc
Emitter-Base Voltage	V_{EBO}	4	Vdc
Collector Current — Continuous — Peak	I_C	9 12	Adc
Total Device Dissipation @ $T_C = 25^\circ\text{C}$ (1) Derate above 25°C	P_D	250 1.43	Watts W/ $^\circ\text{C}$
Storage Temperature Range	T_{stg}	-65 to +150	$^\circ\text{C}$

THERMAL CHARACTERISTICS

Characteristic	Symbol	Max	Unit
Thermal Resistance, Junction to Case (2)	$R_{\theta JC}$	0.7	$^\circ\text{C/W}$

ELECTRICAL CHARACTERISTICS ($T_C = 25^\circ\text{C}$ unless otherwise noted)

Characteristic	Symbol	Min	Typ	Max	Unit
----------------	--------	-----	-----	-----	------

OFF CHARACTERISTICS

Collector-Emitter Breakdown Voltage ($I_C = 80 \text{ mAdc}$, $I_B = 0$)	$V_{(BR)CEO}$	30	—	—	Vdc
Collector-Emitter Breakdown Voltage ($I_C = 80 \text{ mAdc}$, $V_{BE} = 0$)	$V_{(BR)CES}$	60	—	—	Vdc
Emitter-Base Breakdown Voltage ($I_E = 8 \text{ mAdc}$, $I_C = 0$)	$V_{(BR)EBO}$	4	—	—	Vdc

- (1) This device is designed for RF operation. The total device dissipation rating applies only when the device is operated as an RF amplifier.
 (2) Thermal Resistance is determined under specified RF operating conditions by infrared measurement techniques.

ELECTRICAL CHARACTERISTICS — continued ($T_C = 25^\circ\text{C}$ unless otherwise noted)

Characteristic	Symbol	Min	Typ	Max	Unit
OFF CHARACTERISTICS					
Collector-Base Breakdown Voltage ($I_C = 80 \text{ mAdc}$, $I_E = 0$)	$V_{(BR)CBO}$	60	—	—	Vdc
Collector Cutoff Current ($V_{CB} = 30 \text{ Vdc}$, $I_E = 0$)	I_{CBO}	—	—	5	mAdc

ON CHARACTERISTICS

DC Current Gain ($I_C = 4 \text{ Adc}$, $V_{CE} = 5 \text{ Vdc}$)	h_{FE}	20	—	80	—
---	----------	----	---	----	---

DYNAMIC CHARACTERISTICS

Output Capacitance ($V_{CB} = 28 \text{ Vdc}$, $I_E = 0$, $f = 1 \text{ MHz}$)	C_{ob}	—	95	125	pF
---	----------	---	----	-----	----

FUNCTIONAL TESTS (Figure 1)

Common-Emitter Amplifier Power Gain ($V_{CC} = 28 \text{ Vdc}$, $P_{out} = 80 \text{ W}$, $f = 470 \text{ MHz}$)	G_{PE}	7.3	8.8	—	dB
Collector Efficiency ($V_{CC} = 28 \text{ Vdc}$, $P_{out} = 80 \text{ W}$, $f = 470 \text{ MHz}$)	η	50	60	—	%
Load Mismatch ($V_{CC} = 28 \text{ Vdc}$, $P_{out} = 80 \text{ W}$, $f = 470 \text{ MHz}$, VSWR = 30:1, All Phase Angles at Frequency of Test)	ψ	No Degradation in Output Power			

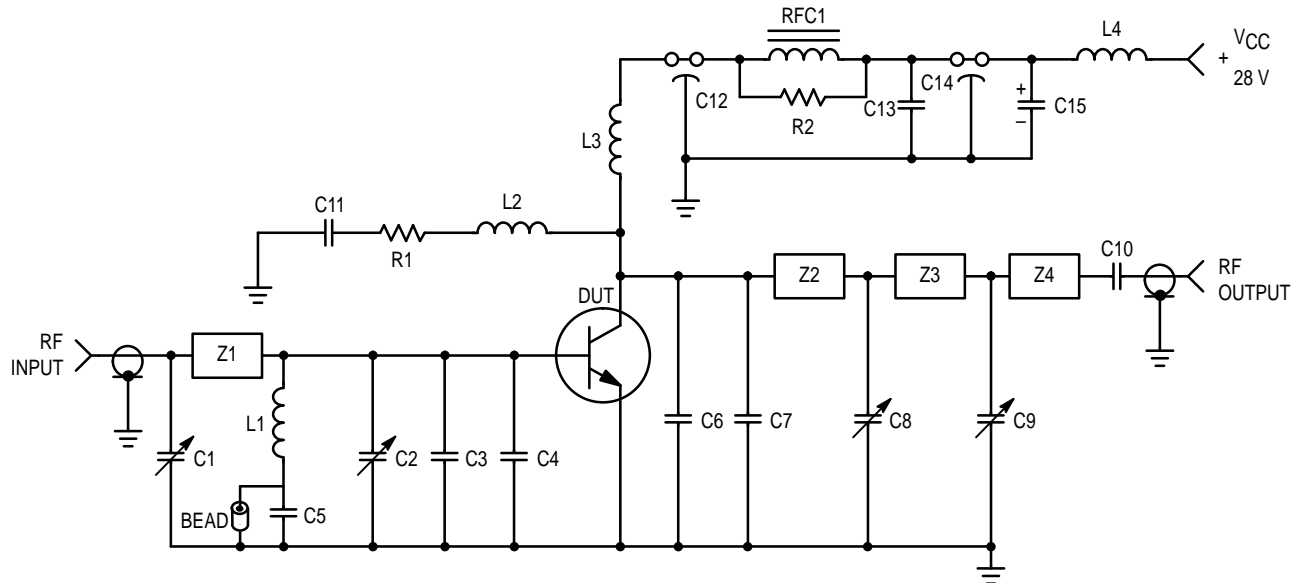

Bead	Ferroxcube #56-590-65/3B	L3	3 Turns #18 AWG, 0.185" ID, Close Wound
C1, C2, C8, C9	0.8-20 pF, Johanson (JMC 5501)	L4	4 Turns #18 AWG, 0.185" ID, Close Wound
C3, C4, C6, C7	25 pF, 100 V, Underwood	RFC1	Ferroxcube VK200 19/4B
C5, C10	100 pF, 100 V, Underwood	R1, R2	10 Ω , 2.0 Watt Carbon
C11, C13	0.1 μF , Erie Redcap	Z1	0.190" W x 2.5" L, Microstrip Lin
C12, C14	680 pF, Feedthru	Z2	0.190" W x 0.289" L, Microstrip Line
C15	1.0 μF , Tantalum	Z3	0.190" W x 0.55" L, Microstrip Line
L1	0.15 μH , Molded Choke	Z4	0.190" W x 0.325" L, Microstrip Line
L2	5 Turns #20 AWG, 0.185" ID, Close Wound	Board	Glass Teflon, $t = 0.062"$, $\epsilon_r = 2.56$

Figure 1. 470 MHz Test Circuit

TYPICAL CHARACTERISTICS

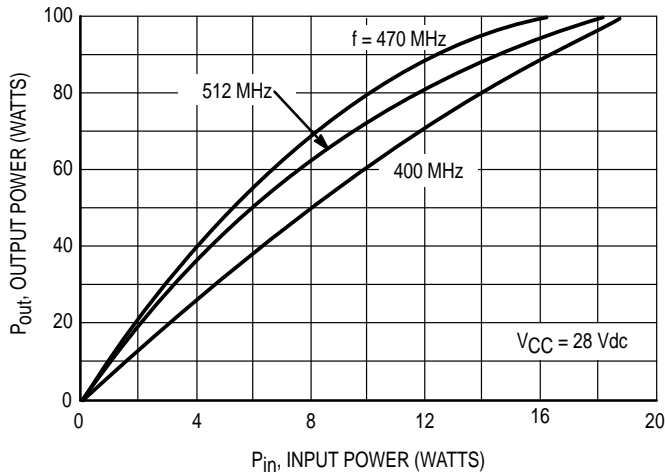

Figure 2. Output Power versus Input Power

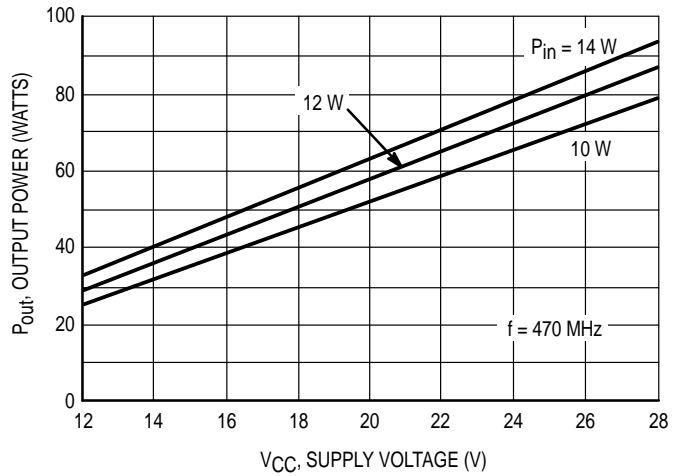

Figure 3. Output Power versus Supply Voltage

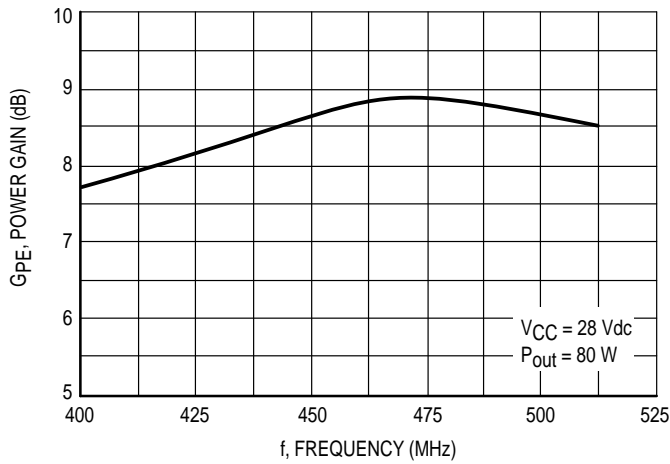

Figure 4. Power Gain versus Frequency

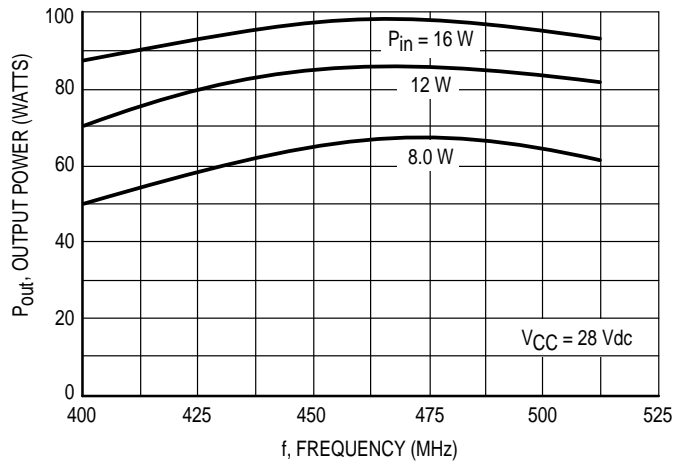
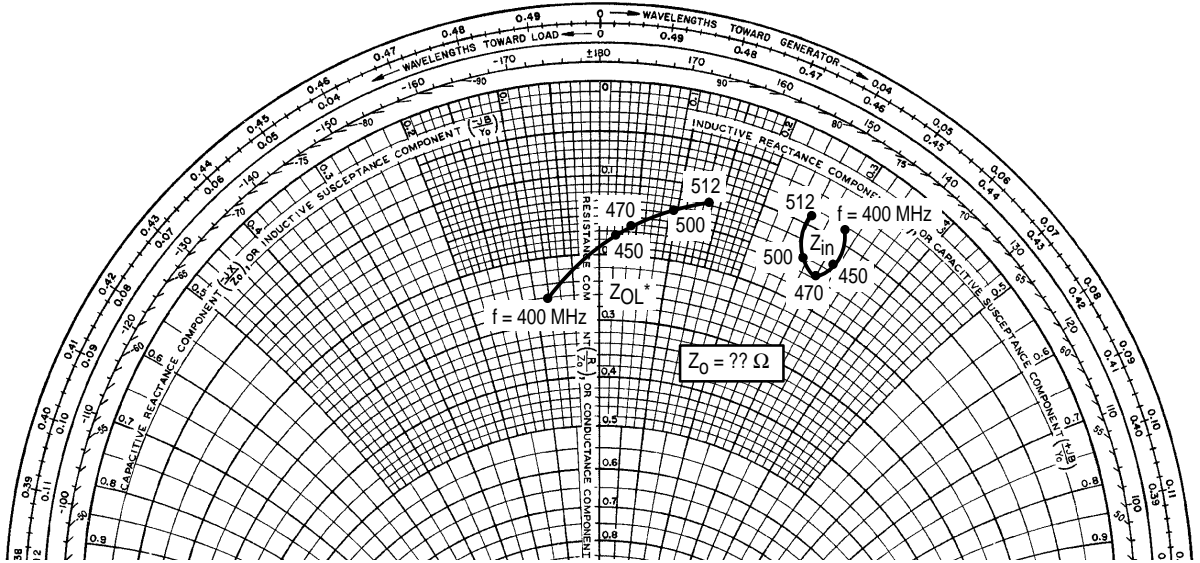

Figure 5. Output Power versus Frequency



$V_{CC} = 28 \text{ V}, P_{out} = 80 \text{ W}$		
f MHz	Z_{in} Ohms	Z_{OL}^* Ohms
512	$0.91 + j2.61$	$1.19 + j1.34$
500	$1.47 + j2.71$	$1.33 + j0.96$
470	$1.53 + j2.98$	$1.60 + j0.45$
450	$1.27 + j3.09$	$1.70 + j0.25$
400	$0.86 + j3.01$	$2.58 - j0.79$

Z_{OL}^* = Conjugate of the optimum load impedance into which the device output operates at a given output power, voltage and frequency.

Figure 6. Series Equivalent Input/Output Impedance

PACKAGE DIMENSIONS

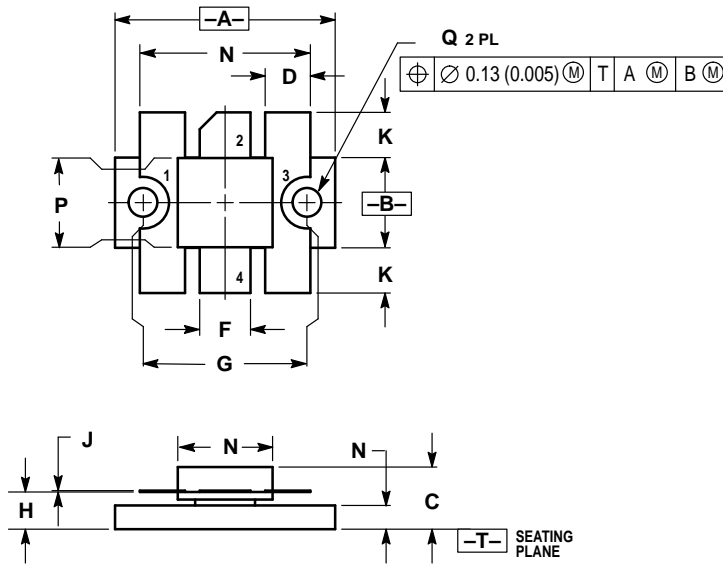

- NOTES:
 1. DIMENSIONING AND TOLERANCING PER ANSI Y14.5M, 1982.
 2. CONTROLLING DIMENSION: INCH.

DIM	INCHES		MILLIMETERS	
	MIN	MAX	MIN	MAX
A	0.965	0.985	24.51	25.02
B	0.390	0.410	9.91	10.41
C	0.250	0.290	6.73	7.36
D	0.190	0.210	4.83	5.33
E	0.095	0.115	2.42	2.92
F	0.215	0.235	5.47	5.96
G	0.725 BSC		18.42 BSC	
H	0.155	0.175	3.94	4.44
J	0.004	0.006	0.10	0.15
K	0.195	0.205	4.95	5.21
L	0.740	0.770	18.80	19.55
N	0.415	0.425	10.54	10.80
P	0.390	0.400	9.91	10.16
Q	0.120	0.135	3.05	3.42

- STYLE 1:
 PIN 1. EMITTER
 2. COLLECTOR
 3. EMITTER
 4. BASE

**CASE 333-04
 ISSUE E**

Motorola reserves the right to make changes without further notice to any products herein. Motorola makes no warranty, representation or guarantee regarding the suitability of its products for any particular purpose, nor does Motorola assume any liability arising out of the application or use of any product or circuit, and specifically disclaims any and all liability, including without limitation consequential or incidental damages. "Typical" parameters which may be provided in Motorola data sheets and/or specifications can and do vary in different applications and actual performance may vary over time. All operating parameters, including "Typicals" must be validated for each customer application by customer's technical experts. Motorola does not convey any license under its patent rights nor the rights of others. Motorola products are not designed, intended, or authorized for use as components in systems intended for surgical implant into the body, or other applications intended to support or sustain life, or for any other application in which the failure of the Motorola product could create a situation where personal injury or death may occur. Should Buyer purchase or use Motorola products for any such unintended or unauthorized application, Buyer shall indemnify and hold Motorola and its officers, employees, subsidiaries, affiliates, and distributors harmless against all claims, costs, damages, and expenses, and reasonable attorney fees arising out of, directly or indirectly, any claim of personal injury or death associated with such unintended or unauthorized use, even if such claim alleges that Motorola was negligent regarding the design or manufacture of the part. Motorola and  are registered trademarks of Motorola, Inc. Motorola, Inc. is an Equal Opportunity/Affirmative Action Employer.

Mfax is a trademark of Motorola, Inc.

How to reach us:

USA/EUROPE/Locations Not Listed: Motorola Literature Distribution;
P.O. Box 5405, Denver, Colorado 80217. 303-675-2140 or 1-800-441-2447

JAPAN: Nippon Motorola Ltd.: SPD, Strategic Planning Office, 4-32-1,
Nishi-Gotanda, Shinagawa-ku, Tokyo 141, Japan. 81-3-5487-8488

Mfax™: RMFAX0@email.sps.mot.com – TOUCHTONE 602-244-6609
– US & Canada ONLY 1-800-774-1848

ASIA/PACIFIC: Motorola Semiconductors H.K. Ltd.; 8B Tai Ping Industrial Park,
51 Ting Kok Road, Tai Po, N.T., Hong Kong. 852-26629298

INTERNET: <http://motorola.com/sps>



MOTOROLA



MRF338/D