

The MRFIC Line

1.8 GHz Antenna Switch

Designed primarily for use in DECT, Japan Personal Handy System (PHS), other wireless Personal Communication Systems (PCS) applications, and 2.4 GHz ISM band applications. The MRFIC1801 is a single pole, double throw reflective antenna switch featuring low insertion loss and high power handling capability in a low-cost SOIC-8 package. The integrated circuit requires no off-chip matching and provides for easy control circuit interface. The high power handling capability allows application in higher power wireless systems than traditional GaAs antenna switches.

Together with the rest of the MRFIC180X series, this GaAs IC family offers the complete transmit and receive functions, less LO and filters, needed for a typical 1.8 GHz cordless telephone.

- Usable Frequency Range 1.5 to 2.5 GHz
- High 1.0 dB Compression Point = 29 dBm (Typ)
- Low Transmit Insertion Loss = 0.75 dB (Typ)
- High Transmit to Receive Isolation = 22 dB (Typ)
- Single Control Pin for Easy Switching Signal Interface
- Low Current Drain = 300 μ A (Typ) in TX, 45 μ A (Typ) in RX
- Low Cost Surface Mount Plastic Package
- Order MRFIC1801R2 for Tape and Reel.
R2 Suffix = 2,500 Units per 12 mm, 13 inch Reel.
- Device Marking = M1801

MRFIC1801

**1.8 GHz
TRANSMIT/RECEIVE
ANTENNA SWITCH
GaAs MONOLITHIC
INTEGRATED CIRCUIT**

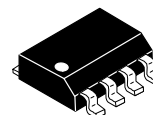

**CASE 751-05
(SO-8)**

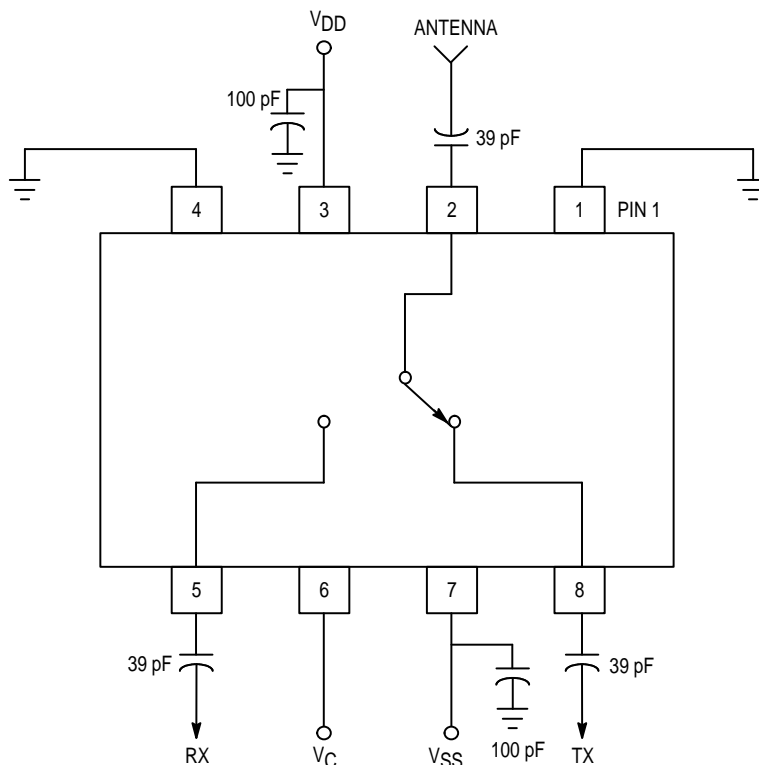

Functional Block Diagram and Pin Assignment

MAXIMUM RATINGS ($T_A = 25^\circ\text{C}$ unless otherwise noted)

Ratings	Symbol	Value	Unit
Supply Voltage	V_{DD}	10	Vdc
Supply Voltage Difference	$V_{DD} - V_{SS}$	8	Vdc
RF Input Power	P_{in}	33	dBm
Switch Control Voltage	V_C	$V_{DD} + 1, V_{SS} - 1$	Vdc
Storage Temperature Range	T_{stg}	- 65 to +150	$^\circ\text{C}$
Operating Ambient Temperature	T_A	- 30 to + 85	$^\circ\text{C}$

RECOMMENDED OPERATING CONDITIONS

Parameter	Symbol	Value	Unit
Supply Voltage	V_{DD}	2.7 to 5.5	Vdc
Supply Voltage Difference	$V_{DD} - V_{SS}$	5.5	Vdc
Switch Control Voltage	V_C	V_{DD} to V_{SS}	Vdc
Operating Frequency	f	1.5 to 2.5	GHz

ELECTRICAL CHARACTERISTICS ($V_{DD} - V_{SS} = 5.5\text{ V}$, $T_A = 25^\circ\text{C}$, $f = 1.9\text{ GHz}$)

Characteristic	Min	Typ	Max	Unit
Antenna to Receive Insertion Loss (RX Mode, $P_{IN} = 0\text{ dBm}$)	—	0.8	1	dB
Transmit to Antenna Insertion Loss (TX Mode, $P_{IN} = +27\text{ dBm}$)	—	0.6	1	dB
Transmit to Receive Isolation in TX Mode ($P_{IN} = +27\text{ dBm}$)	—	22	—	dB
Antenna to Transmit Isolation in RX Mode ($P_{IN} = 0\text{ dBm}$)	—	18	—	dB
Input Return Loss, all ports	—	15	—	dB
Transmit to Antenna Input 1.0 dB Compression	—	29	—	dBm
Leakage Current (RX Mode)	—	45	—	μA
Total Supply Current (TX Mode)	—	300	—	μA

EVALUATION BOARDS

Evaluation boards are available for RF Monolithic Integrated Circuits by adding a "TF" suffix to the device type. For a complete list of currently available boards and ones in development for newly introduced product, please contact your local Motorola Distributor or Sales Office.

APPLICATIONS INFORMATION

The MRFIC1801 is a SPDT switch. A series–shunt pair of FETs are used in each path for improved isolation. The power handling capability of the MRFIC1801 is determined by the difference between V_{DD} and V_{SS} . Typical operating conditions are $V_{DD} = 3.0\text{ V}$ and $V_{SS} = -2.5\text{ V}$, but a negative V_{SS} is not required. V_{SS} can be grounded.

Mode	V_C
RX	V_{SS}
TX	V_{DD}

Table 1. Logic Table

TYPICAL CHARACTERISTICS
($V_{DD} - V_{SS} = 5.5\text{ V}$)

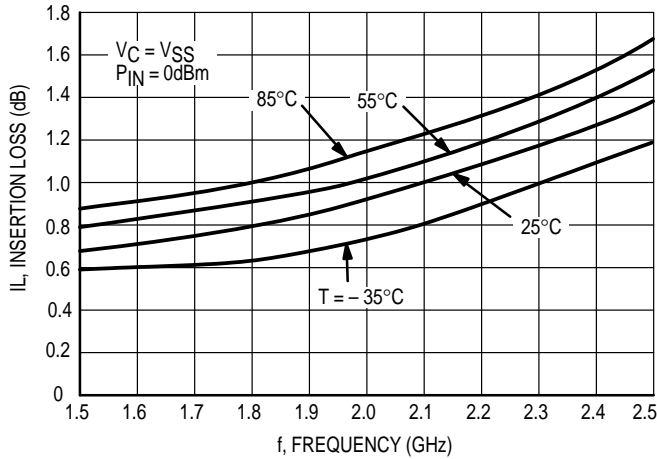

Figure 1. Antenna to Receive Insertion Loss

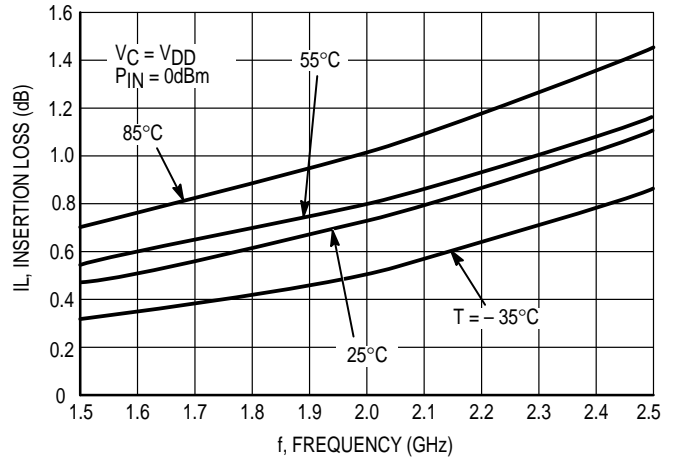

Figure 2. Transmit to Antenna Insertion Loss (Small Signal)

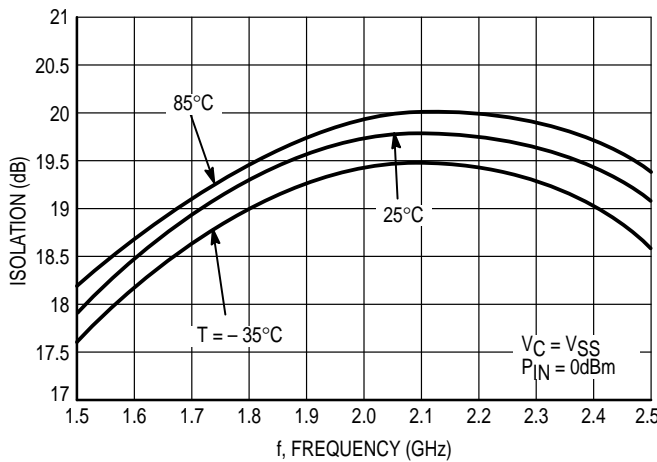

Figure 3. Antenna to Transmit Isolation in RX Mode

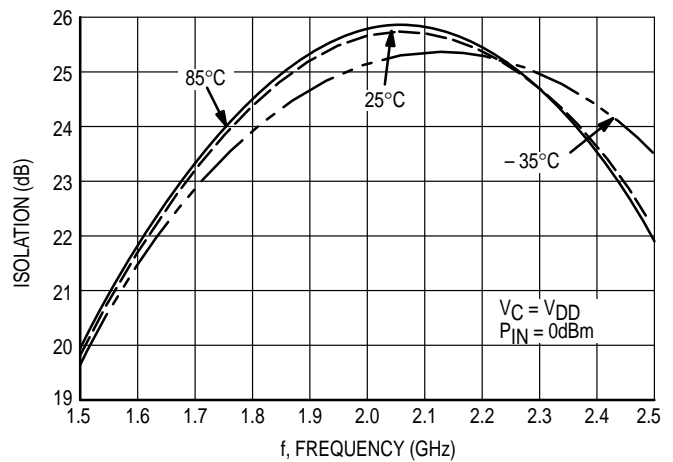

Figure 4. Transmit to Receive Isolation in TX Mode

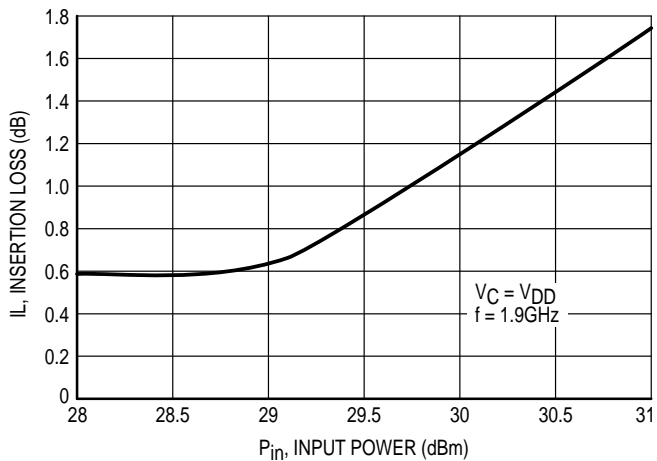

Figure 5. Antenna Switch Insertion Loss versus Input Power (Large Signal)

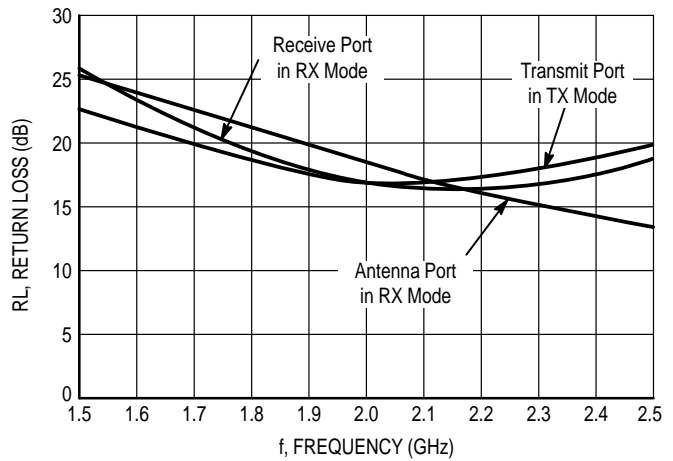
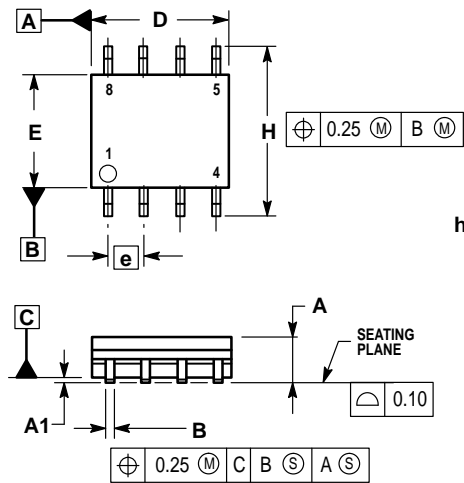

Figure 6. Return Loss

PACKAGE DIMENSIONS



- NOTES:
1. DIMENSIONING AND TOLERANCING PER ASME Y14.5M, 1994.
 2. DIMENSIONS ARE IN MILLIMETERS.
 3. DIMENSION D AND E DO NOT INCLUDE MOLD PROTRUSION.
 4. MAXIMUM MOLD PROTRUSION 0.15 PER SIDE.
 5. DIMENSION B DOES NOT INCLUDE MOLD PROTRUSION. ALLOWABLE DAMBAR PROTRUSION SHALL BE 0.127 TOTAL IN EXCESS OF THE B DIMENSION AT MAXIMUM MATERIAL CONDITION.

DIM	MILLIMETERS	
	MIN	MAX
A	1.35	1.75
A1	0.10	0.25
B	0.35	0.49
C	0.18	0.25
D	4.80	5.00
E	3.80	4.00
e	1.27 BSC	
H	5.80	6.20
h	0.25	0.50
L	0.40	1.25
θ	0°	7°

CASE 751-05 ISSUE S

Motorola reserves the right to make changes without further notice to any products herein. Motorola makes no warranty, representation or guarantee regarding the suitability of its products for any particular purpose, nor does Motorola assume any liability arising out of the application or use of any product or circuit, and specifically disclaims any and all liability, including without limitation consequential or incidental damages. "Typical" parameters which may be provided in Motorola data sheets and/or specifications can and do vary in different applications and actual performance may vary over time. All operating parameters, including "Typicals" must be validated for each customer application by customer's technical experts. Motorola does not convey any license under its patent rights nor the rights of others. Motorola products are not designed, intended, or authorized for use as components in systems intended for surgical implant into the body, or other applications intended to support or sustain life, or for any other application in which the failure of the Motorola product could create a situation where personal injury or death may occur. Should Buyer purchase or use Motorola products for any such unintended or unauthorized application, Buyer shall indemnify and hold Motorola and its officers, employees, subsidiaries, affiliates, and distributors harmless against all claims, costs, damages, and expenses, and reasonable attorney fees arising out of, directly or indirectly, any claim of personal injury or death associated with such unintended or unauthorized use, even if such claim alleges that Motorola was negligent regarding the design or manufacture of the part. Motorola and  are registered trademarks of Motorola, Inc. Motorola, Inc. is an Equal Opportunity/Affirmative Action Employer.

Mfax is a trademark of Motorola, Inc.

How to reach us:

USA/EUROPE/Locations Not Listed: Motorola Literature Distribution;
P.O. Box 5405, Denver, Colorado 80217. 303-675-2140 or 1-800-441-2447

JAPAN: Nippon Motorola Ltd.: SPD, Strategic Planning Office, 4-32-1,
Nishi-Gotanda, Shinagawa-ku, Tokyo 141, Japan. 81-3-5487-8488

Mfax™: RMFAX0@email.sps.mot.com – TOUCHTONE 602-244-6609
– US & Canada ONLY 1-800-774-1848

ASIA/PACIFIC: Motorola Semiconductors H.K. Ltd.; 8B Tai Ping Industrial Park,
51 Ting Kok Road, Tai Po, N.T., Hong Kong. 852-26629298

INTERNET: <http://motorola.com/sps>

