

The MRFIC Line

900 MHz Transmit Mixer

The MRFIC2002 is a double-balanced, active mixer designed for transmitters operating in the 800 MHz to 1.0 GHz frequency range. The design utilizes Motorola's advanced MOSAIC 3 silicon bipolar RF process to yield superior performance in a cost effective monolithic device. Applications for the MRFIC2002 include CT1 and CT2 cordless telephones, GSM, remote controls, video and audio short range links, low cost cellular radios, and ISM band transmitters. A power down control is provided to minimize current drain with minimum recovery/turn-on time.

- Conversion Gain = 10 dB (Typ)
- Supply Current = 5.5 mA (Typ)
- Power Down Supply Current = 2.0 μ A (Max)
- LO-RF Isolation = 25 dB (Typ)
- Low LO Drive Required = -10 dBm (Typ)
- LO Impedance Insensitive to Power Down
- No Matching Required for RF OUT Port
- All Ports are Single Ended
- Order MRFIC2002R2 for Tape and Reel.
R2 Suffix = 2,500 Units per 12 mm, 13 inch Reel.
- Device Marking = M2002

MRFIC2002

**900 MHz TX-MIXER
SILICON MONOLITHIC
INTEGRATED CIRCUIT**

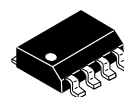

**CASE 751-05
(SO-8)**

ABSOLUTE MAXIMUM RATINGS ($T_A = 25^\circ\text{C}$ unless otherwise noted)

Rating	Symbol	Value	Unit
Supply Voltage	V_{CC}	5.5	Vdc
Control Voltages	ENABLE, V_{RAMP}	5.0	Vdc
Input Power, LO and IF Ports	P_{LO} , P_{IF}	+10	dBm
Operating Ambient Temperature	T_A	-35 to +85	$^\circ\text{C}$
Storage Temperature	T_{stg}	-65 to +150	$^\circ\text{C}$

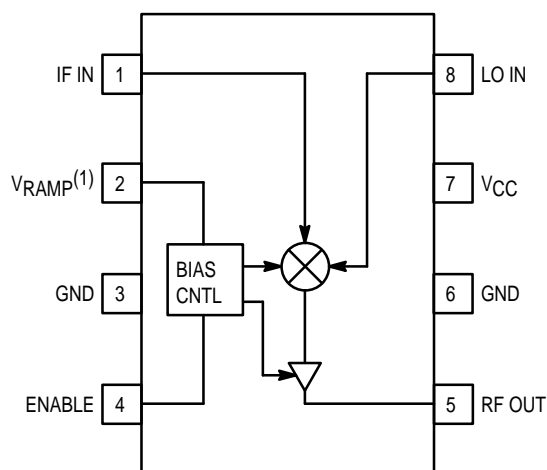

(1) For CT2 applications, apply ramp voltage provided in MRFIC2004. For non-CT2, leave open circuited.

Pin Connections and Functional Block Diagram

RECOMMENDED OPERATING RANGES

Parameter	Symbol	Value	Unit
Supply Voltage Range	V_{CC}	2.7 to 5.0	Vdc
Control Voltage Ranges	ENABLE, V_{RAMP}	0 to 5.0	Vdc
RF Port Frequency Range	f_{RF}	500 to 1000	MHz
IF Port Frequency Range	f_{IF}	0 (dc) to 250	MHz

ELECTRICAL CHARACTERISTICS (V_{CC} , Enable = 3.0 V and V_{Ramp} ⁽¹⁾ Open Circuited, $P_{LO} = -7.0$ dBm, IF @ 100 MHz, LO @ 1.0 GHz, RF @ 900 MHz, $T_A = 25^\circ\text{C}$ unless otherwise noted)

Characteristic (2)	Min	Typ	Max	Unit
Supply Current: On-Mode	—	5.5	7.0	mA
Supply Current: Off-Mode (Enable < 1.0 V)	—	0.1	2.0	μA
Enable Response Time	—	1.0	—	μs
Conversion Gain	8.0	10	12	dB
Single Sideband Noise Figure	—	10	—	dB
Output Power at 1.0 dB Gain Compression	—	-18	—	dBm
Output Power at Saturation	-16	-14	—	dBm
LO-RF Isolation (1.0 GHz)	—	25	—	dB
LO-IF Isolation (1.0 GHz)	—	65	—	dB
IF-RF Isolation (100 MHz)	—	18	—	dB
IF-LO Isolation (100 MHz)	—	50	—	dB

NOTES:

- For CT2 applications, apply ramp voltage provided in MRFIC2004. For non-CT2, leave open circuited.
- All Electrical Characteristics are measured in test circuit schematic as shown in Figure 1.

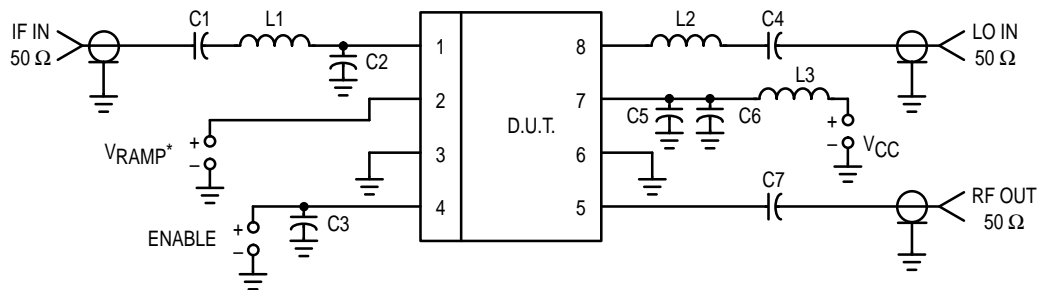

C1, C3, C6 — 1000 pF Chip Capacitor	L2 — 10 nH Chip Inductor
C2 — 6.8 pF Chip Capacitor	L3 — 390 nH Chip Inductor
C4 — 3.9 pF Chip Capacitor	RF Connectors — SMA Type
C5 — 100 pF Chip Capacitor	Board Material — Glass/Epoxy $\epsilon_r = 4.5$,
C7 — 5.6 pF Chip Capacitor	Dielectric Thickness = 0.014" (0.36 mm)
L1 — 270 nH Chip Inductor	

Figure 1. Test Circuit Configuration

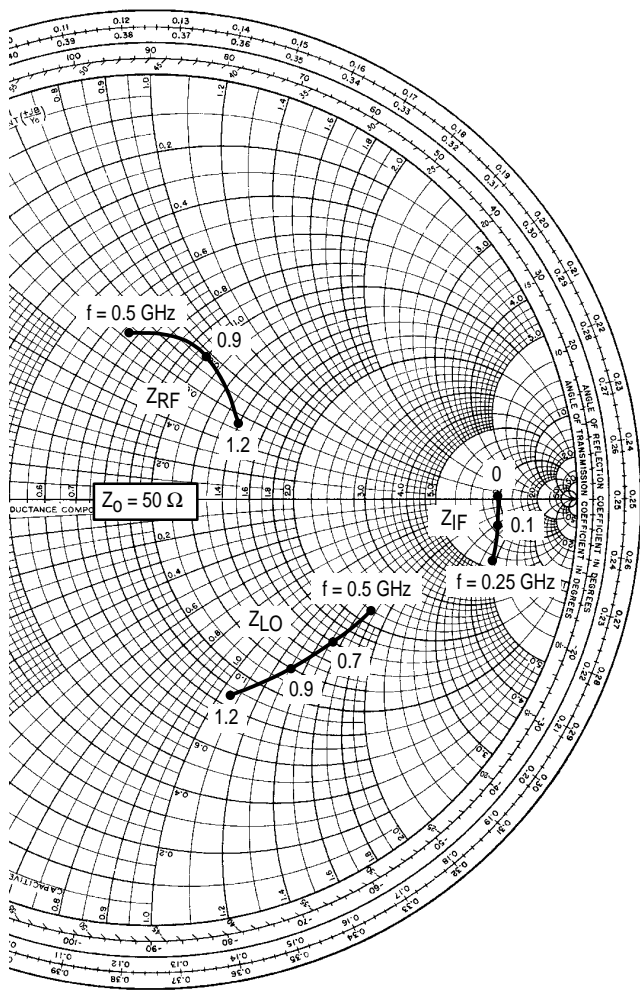

Figure 2. Port Impedances versus Frequency

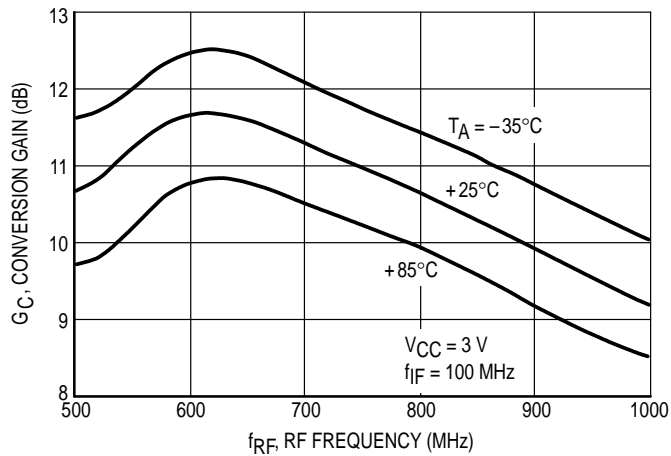

Figure 3. Gain versus RF Frequency

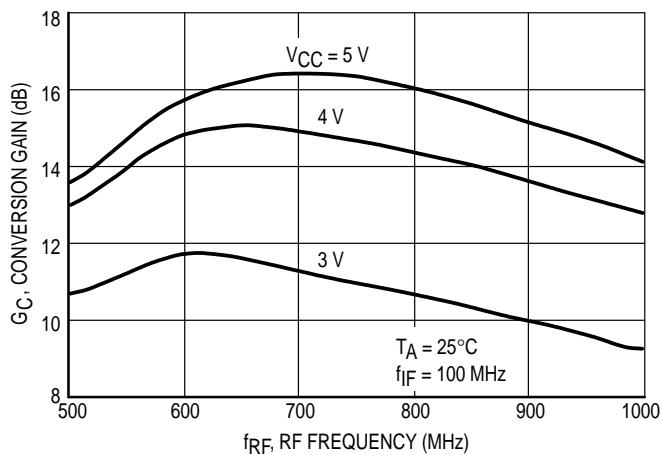

Figure 4. Gain versus RF Frequency

V _{CC} (Volts)	f (MHz)	Γ _{IF}		Γ _{RF}		Γ _{LO}	
		Mag	∠φ Degrees	Mag	∠φ Degrees	Mag	∠φ Degrees
3.0	50	0.83	-2.4	—	—	—	—
	100	0.82	-4.7	—	—	—	—
	150	0.82	-7.1	—	—	—	—
	200	0.81	-9.6	—	—	—	—
	250	0.81	-11.7	—	—	—	—
	500	—	—	0.42	100	0.57	-29
	600	—	—	0.41	94	0.55	-35
	700	—	—	0.40	88	0.54	-41
	800	—	—	0.39	80	0.52	-48
	900	—	—	0.36	71	0.51	-54
	1000	—	—	0.33	63	0.50	-60
	1100	—	—	0.31	55	0.49	-65
1200	—	—	0.28	45	0.49	-70	

Table 1. Deembedded Port Reflection Coefficients
(Enable = 3.0 V, Z₀ = 50 Ω, T_A = 25°C)

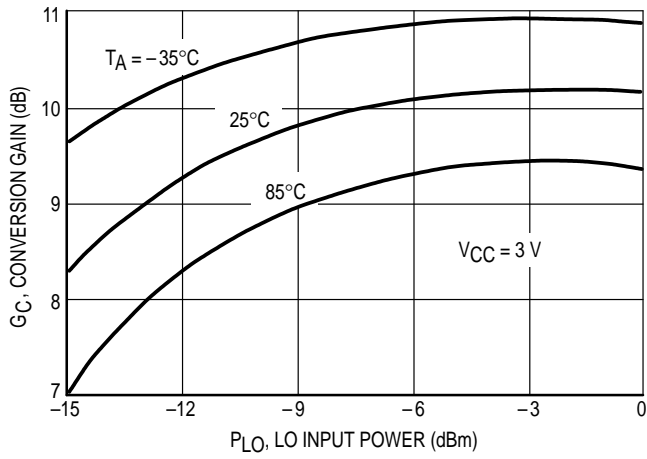

Figure 5. Gain versus LO Input Power

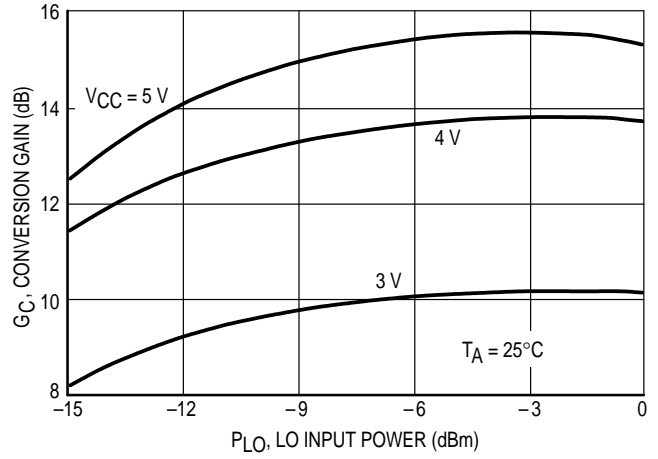

Figure 6. Gain versus LO Input Power

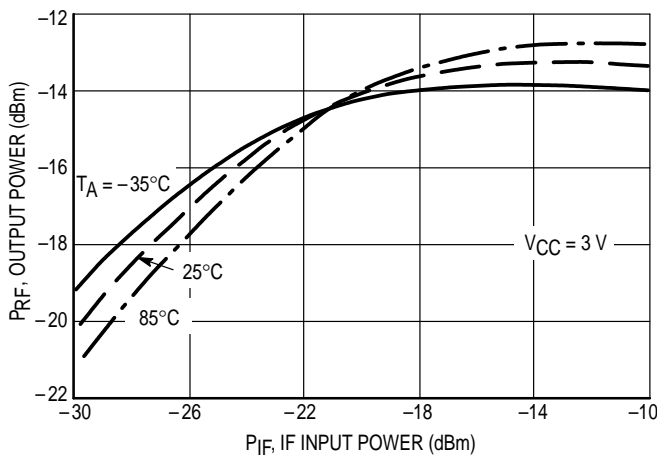

Figure 7. Output Power versus IF Input Power

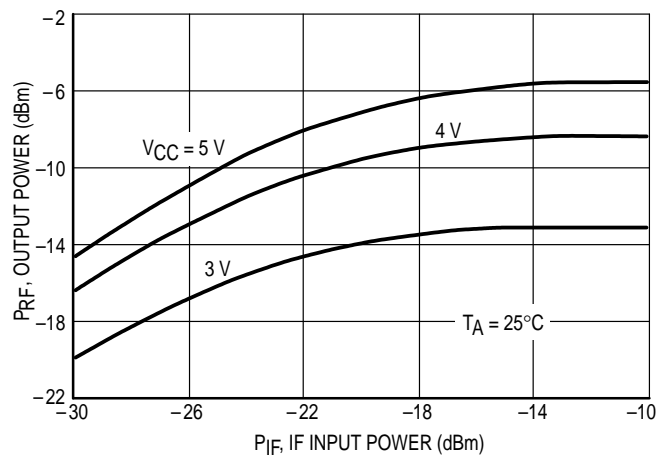

Figure 8. Output Power versus IF Input Power

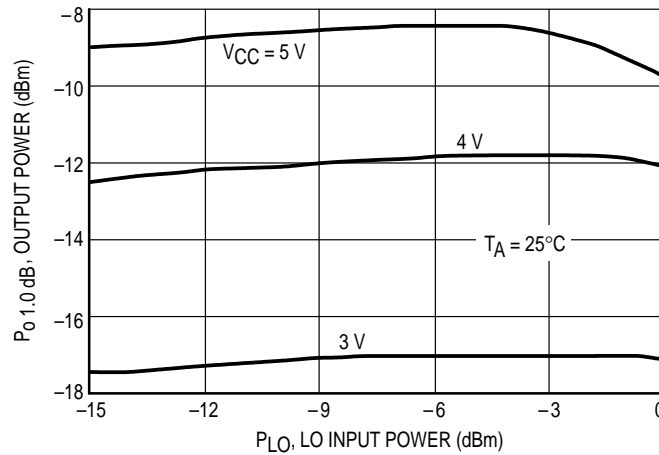

Figure 9. Output Power at 1.0 dB Gain Compression versus LO Input Power

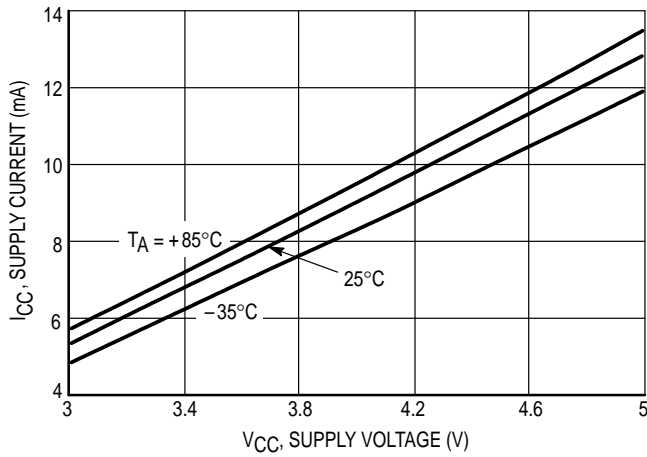

Figure 10. I_{CC} versus V_{CC}

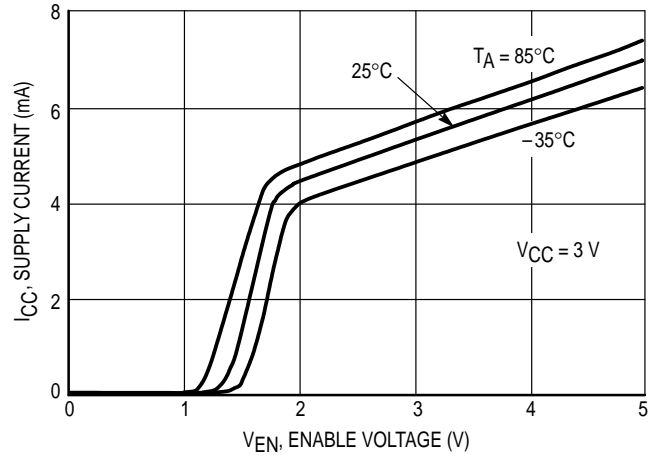

Figure 11. I_{CC} versus Enable Voltage

APPLICATIONS INFORMATION

DESIGN PHILOSOPHY

The MRFIC2002 was designed to have excellent LO and spurious rejection. This is accomplished by using a double-balanced configuration and using a symmetrical die layout.

To eliminate the need for external baluns or decoupling elements, the unused LO and IF ports are decoupled internally. Only one of the RF outputs is used, eliminating the need for an external balun on the RF port as well. Also, the RF port is buffered to provide a 50 ohm output impedance. External matching is required for the LO and IF ports.

To minimize current drain in various TDD/TDMA systems, two methods of enabling/disabling the MRFIC2002 are provided: one that is TTL/CMOS compatible and one that is triggered from a ramp, such as the one provided in the MRFIC2004. The former method must be used if a ramp is not available. The latter method is more desirable since the MRFIC2002 can remain off during guard times and while in idle mode.

THEORY OF OPERATION

Matching the LO port to 50 ohms can be done several ways. The recommended approach is a series inductor as close to the IC as possible. The inductor value is small enough (~8–15 nH depending on LO frequency) to be printed on the board. A DC block is required and should not be placed between the inductor and IC since this will prevent the inductor from being placed close enough to the IC to provide a good match.

The IF port is approximately 500 ohms resistive in parallel with 1.3 pF of capacitance. If 50 ohms is the desired IF port impedance, a shunt capacitor followed by a series inductor

will provide the transformation. A DC block is required and can be placed on either side of the matching network.

The RF port is nearly 50 ohms resistive in series with a small amount of inductive reactance, which results in an 8–11 dB return loss. However, a series 5.6 pF capacitor placed as close to the IC as possible will typically provide greater than a 15 dB return loss. The series capacitor also serves as a DC block which is required.

Supply decoupling must be done as close to the IC as possible. A 1000 pF capacitor is recommended. An additional 100 pF capacitor and an RF choke are recommended to keep the RF and LO signals off the supply line.

For systems that use a ramp, like the one provided in the MRFIC2004, enabling/disabling can be done by applying the ramp voltage to the V_{RAMP} pin which trips the IC between 0.6 and 1.0 volts. The Enable pin must either be tied high or to the inverse of the receiver enable control line, RXEN. An inverter is provided in the MRFIC2004 to invert RXEN.

For systems that do not use a ramp, the V_{RAMP} pin can be left open circuited and enabling/disabling the MRFIC2002 can be done with its TTL/CMOS compatible Enable pin. The trip point is between 1.0 and 2.0 volts.

EVALUATION BOARDS

Evaluation boards are available for RF Monolithic Integrated Circuits by adding a "TF" suffix to the device type. For a complete list of currently available boards and ones in development for newly introduced product, please contact your local Motorola Distributor or Sales Office.

PACKAGE DIMENSIONS

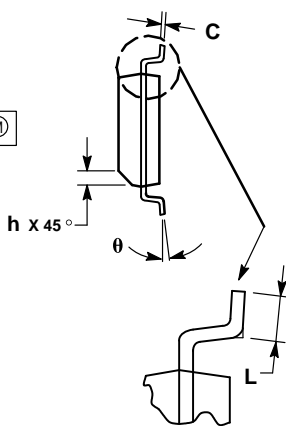
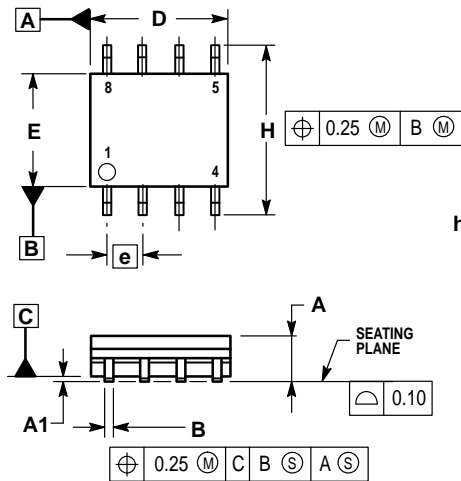

- NOTES:
1. DIMENSIONING AND TOLERANCING PER ASME Y14.5M, 1994.
 2. DIMENSIONS ARE IN MILLIMETERS.
 3. DIMENSION D AND E DO NOT INCLUDE MOLD PROTRUSION.
 4. MAXIMUM MOLD PROTRUSION 0.15 PER SIDE.
 5. DIMENSION B DOES NOT INCLUDE MOLD PROTRUSION. ALLOWABLE DAMBAR PROTRUSION SHALL BE 0.127 TOTAL IN EXCESS OF THE B DIMENSION AT MAXIMUM MATERIAL CONDITION.

DIM	MILLIMETERS	
	MIN	MAX
A	1.35	1.75
A1	0.10	0.25
B	0.35	0.49
C	0.18	0.25
D	4.80	5.00
E	3.80	4.00
e	1.27 BSC	
H	5.80	6.20
h	0.25	0.50
L	0.40	1.25
θ	0°	7°

CASE 751-05 ISSUE S

Motorola reserves the right to make changes without further notice to any products herein. Motorola makes no warranty, representation or guarantee regarding the suitability of its products for any particular purpose, nor does Motorola assume any liability arising out of the application or use of any product or circuit, and specifically disclaims any and all liability, including without limitation consequential or incidental damages. "Typical" parameters which may be provided in Motorola data sheets and/or specifications can and do vary in different applications and actual performance may vary over time. All operating parameters, including "Typicals" must be validated for each customer application by customer's technical experts. Motorola does not convey any license under its patent rights nor the rights of others. Motorola products are not designed, intended, or authorized for use as components in systems intended for surgical implant into the body, or other applications intended to support or sustain life, or for any other application in which the failure of the Motorola product could create a situation where personal injury or death may occur. Should Buyer purchase or use Motorola products for any such unintended or unauthorized application, Buyer shall indemnify and hold Motorola and its officers, employees, subsidiaries, affiliates, and distributors harmless against all claims, costs, damages, and expenses, and reasonable attorney fees arising out of, directly or indirectly, any claim of personal injury or death associated with such unintended or unauthorized use, even if such claim alleges that Motorola was negligent regarding the design or manufacture of the part. Motorola and are registered trademarks of Motorola, Inc. Motorola, Inc. is an Equal Opportunity/Affirmative Action Employer.

Mfax is a trademark of Motorola, Inc.

How to reach us:

USA/EUROPE/Locations Not Listed: Motorola Literature Distribution;
P.O. Box 5405, Denver, Colorado 80217. 303-675-2140 or 1-800-441-2447

JAPAN: Nippon Motorola Ltd.: SPD, Strategic Planning Office, 4-32-1,
Nishi-Gotanda, Shinagawa-ku, Tokyo 141, Japan. 81-3-5487-8488

Mfax™: RMFAX0@email.sps.mot.com – TOUCHTONE 602-244-6609
– US & Canada ONLY 1-800-774-1848

ASIA/PACIFIC: Motorola Semiconductors H.K. Ltd.; 8B Tai Ping Industrial Park,
51 Ting Kok Road, Tai Po, N.T., Hong Kong. 852-26629298

INTERNET: <http://motorola.com/sps>

