

The MRFIC Line

2.4 GHz GaAs Exciter Amplifier

The MRFIC2404 is a single-stage class A GaAs amplifier in a low-cost 8 lead plastic package designed to drive the MRFIC2403 power amplifier for use in the 2.4 to 2.5 GHz Industrial-Scientific-Medical (ISM) band. The design is optimized for 5.0 Volt operation at 2.45 GHz but is usable from 2.0 to 3.0 GHz in applications such as telemetry and Multichannel Multipoint Distribution System (MMDS) wireless cable TV systems. Performance is suitable for frequency hopping or direct sequence spread spectrum as well as single-frequency applications.

- High Output Capability = +5.0 dBm Typical
- High Gain = 17 dB Typical
- Low Current Drain = 9.0 mA Typical
- Single Supply Voltage = 5.0 Volts
- Good Noise Figure = 4.3 dB Typical
- Low-Cost, Low Profile Plastic SOIC Package
- Order MRFIC2404R2 for Tape and Reel.
R2 Suffix = 2,500 Units per 12 mm, 13 inch Reel.
- Device Marking = M2404

MRFIC2404

**2.4 GHz
EXCITER AMPLIFIER
GaAs MONOLITHIC
INTEGRATED CIRCUIT**

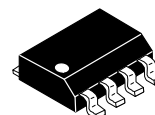

**CASE 751-05
(SO-8)**

ABSOLUTE MAXIMUM RATINGS ($T_A = 25^\circ\text{C}$ unless otherwise noted)

Parameter	Symbol	Value	Unit
Supply Voltage	V_{DD}	12	Vdc
RF Input Power	RF IN	+10	dBm
Bias Enable Voltage	V_{bias}	6.0	Vdc
Ambient Operating Temperature	T_A	-30 to +85	$^\circ\text{C}$
Storage Temperature	T_{stg}	-65 to +125	$^\circ\text{C}$

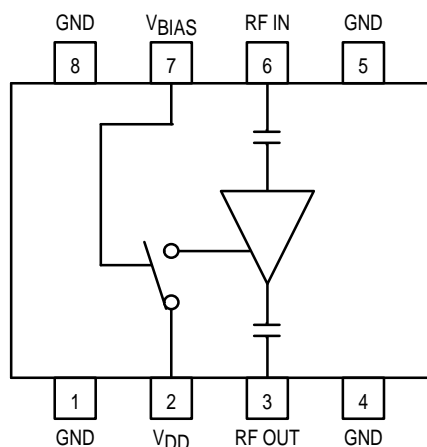

Pin Connections and Functional Block Diagram

RECOMMENDED OPERATING CONDITIONS

Parameter	Symbol	Value	Unit
Supply Voltage	V_{DD}	4.75 to 5.25	Vdc
Bias Enable Voltage – ON	V_{bias}	0	Vdc
Bias Enable Voltage – OFF	V_{bias}	5.0	Vdc
Operating Frequency Range	f_{OP}	2000 to 3000	MHz

ELECTRICAL CHARACTERISTICS ($V_{DD} = 5.0$ Vdc, $T_A = 25^\circ\text{C}$, $R_F = 2.45$ GHz, $V_{bias} = 0$ Vdc)

Characteristic	Min	Typ	Max	Unit
Small Signal Gain	16	17	–	dB
Power Output, 1.0 dB Compression	–	+5.0	–	dBm
Power Output ($P_{in} = -11$ dBm)	4.0	5.0	–	dBm
Third Order Intercept Point	–	+15	–	dBm
Noise Figure	–	4.3	–	dB
Reverse Isolation	–	25	–	dB
Turn On Time	–	1.0	–	μs
Supply Current	–	9.0	12	mA
SLEEP Mode Supply Current ($V_{bias} = 5.0$ Vdc)	–	800	–	μA

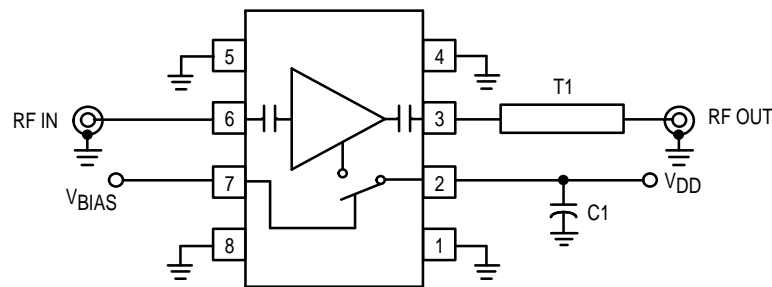

C1 – 15 pF
T1 – 100 Ω Line, 185 MILs (3.3 nH)
Board Material – 30 MIL FR4
Connectors – SMA Type

Figure 1. Applications Circuit Configuration

Table 1. Scattering Parameters
(VDD = 5 V, T_A = 25°C, 50 Ω System)

f (MHz)	S ₁₁		S ₂₁		S ₁₂		S ₂₂	
	S ₁₁	∠ φ	S ₂₁	∠ φ	S ₁₂	∠ φ	S ₂₂	∠ φ
2000	0.232	-92.34	6.290	165.97	0.024	-51.08	0.483	-123.13
2050	0.174	-90.78	7.049	147.75	0.029	-66.26	0.383	-125.77
2100	0.122	-76.88	7.563	127.95	0.032	-78.38	0.281	-124.34
2150	0.102	-48.38	7.803	109.02	0.035	-97.84	0.191	-109.23
2200	0.128	-19.45	8.046	91.04	0.037	-105.62	0.159	-80.33
2250	0.185	-6.60	8.144	72.36	0.039	-123.88	0.196	-53.35
2300	0.244	-5.52	7.977	55.31	0.038	-135.36	0.273	-42.38
2350	0.300	-8.04	7.979	39.91	0.043	-144.83	0.350	-41.15
2400	0.343	-12.42	8.147	23.40	0.044	-160.94	0.423	-43.39
2450	0.379	-17.11	8.020	5.27	0.045	-173.09	0.477	-47.05
2500	0.403	-21.90	7.550	-10.93	0.041	173.83	0.522	-50.67
2550	0.424	-26.32	7.245	-25.36	0.043	165.85	0.556	-54.67
2600	0.436	-30.95	6.911	-39.88	0.042	154.14	0.582	-58.35
2650	0.443	-34.94	6.631	-52.32	0.041	145.35	0.600	-62.23
2700	0.447	-39.48	6.566	-65.57	0.044	135.12	0.610	-65.41
2750	0.445	-43.12	6.338	-79.97	0.043	123.72	0.622	-68.57
2800	0.446	-46.68	6.009	-93.15	0.042	114.52	0.624	-72.06
2850	0.441	-50.42	5.733	-105.10	0.043	107.18	0.620	-74.86
2900	0.439	-53.14	5.565	-116.69	0.041	98.95	0.617	-77.74
2950	0.437	-57.27	5.393	-129.54	0.042	90.72	0.608	-80.01
3000	0.409	-61.28	4.938	-142.70	0.043	81.68	0.611	-81.12

Typical Characteristics

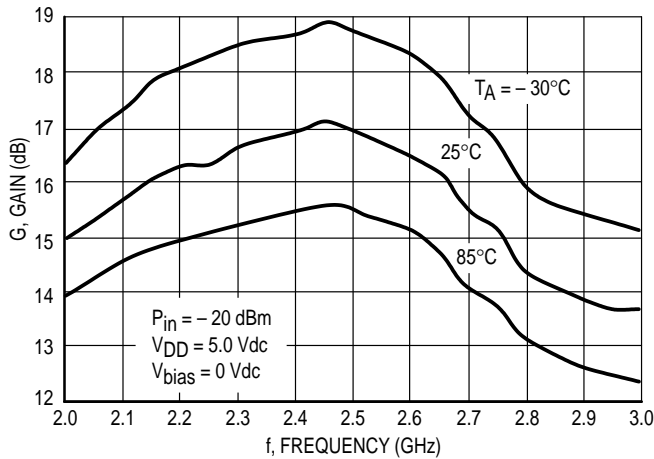

Figure 2. Gain versus Frequency

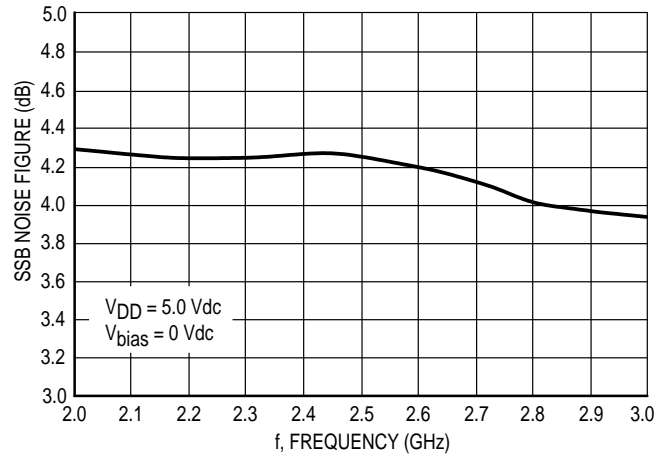

Figure 3. Noise Figure versus Frequency

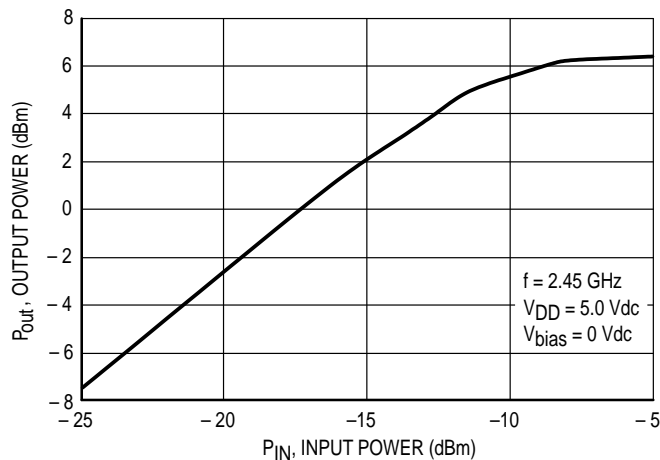

Figure 4. Output Power versus Input Power

DESIGN AND APPLICATIONS INFORMATION

The MRFIC2404 is a single-stage GaAs amplifier designed for exciter applications such as driving the MRFIC2403 power amplifier. The 4.3 dB noise figure, 17 dB gain and +5.0 dBm power output at 1.0 dB gain compression make the MRFIC2404 suitable for high-performance receiver IF application, Multichannel Multipoint Distribution System (MMDS) applications, telemetry and other applications in the 2.0 to 3.0 GHz range.

The characterization curves show typical performance in the 2.0 to 3.0 GHz range in the circuit shown in Figure 1. This circuit was also used to derive the device impedance shown in Table 1. The amplifier input is matched to 50 Ω while the output requires about 3.3 nH series inductance for best

match at 2.45 GHz. The V_{DD} supply line should be bypassed as close to the chip as possible to avoid low frequency oscillations. Power supply "stiffening" and digital transient bypassing in the form of electrolytic or tantalum capacitors should be added.

The device can be put into a reduced current "sleep" mode by 5.0 Vdc to the V_{bias} pin.

EVALUATION BOARDS

Evaluation boards are available for RF Monolithic Integrated Circuits by adding a "TF" suffix to the device type. For a complete list of currently available boards and ones in development for newly introduced product, please contact your local Motorola Distributor or Sales Office.

PACKAGE DIMENSIONS

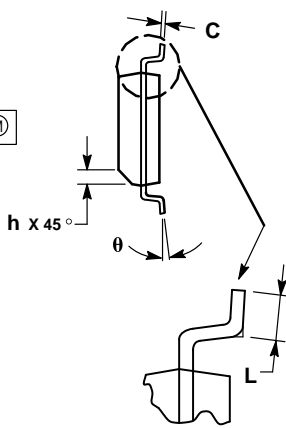
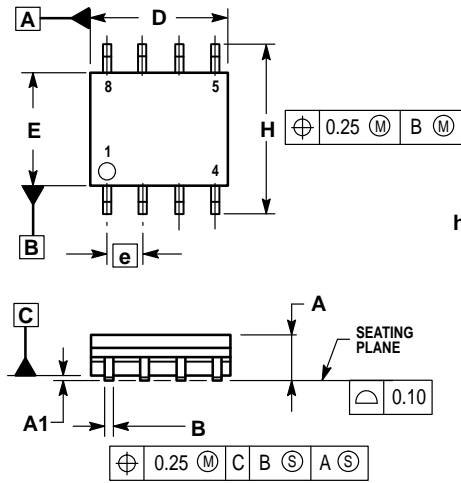

- NOTES:
1. DIMENSIONING AND TOLERANCING PER ASME Y14.5M, 1994.
 2. DIMENSIONS ARE IN MILLIMETERS.
 3. DIMENSION D AND E DO NOT INCLUDE MOLD PROTRUSION.
 4. MAXIMUM MOLD PROTRUSION 0.15 PER SIDE.
 5. DIMENSION B DOES NOT INCLUDE MOLD PROTRUSION. ALLOWABLE DAMBAR PROTRUSION SHALL BE 0.127 TOTAL IN EXCESS OF THE B DIMENSION AT MAXIMUM MATERIAL CONDITION.

DIM	MILLIMETERS	
	MIN	MAX
A	1.35	1.75
A1	0.10	0.25
B	0.35	0.49
C	0.18	0.25
D	4.80	5.00
E	3.80	4.00
e	1.27 BSC	
H	5.80	6.20
h	0.25	0.50
L	0.40	1.25
θ	0°	7°

CASE 751-05
ISSUE S

Motorola reserves the right to make changes without further notice to any products herein. Motorola makes no warranty, representation or guarantee regarding the suitability of its products for any particular purpose, nor does Motorola assume any liability arising out of the application or use of any product or circuit, and specifically disclaims any and all liability, including without limitation consequential or incidental damages. "Typical" parameters which may be provided in Motorola data sheets and/or specifications can and do vary in different applications and actual performance may vary over time. All operating parameters, including "Typicals" must be validated for each customer application by customer's technical experts. Motorola does not convey any license under its patent rights nor the rights of others. Motorola products are not designed, intended, or authorized for use as components in systems intended for surgical implant into the body, or other applications intended to support or sustain life, or for any other application in which the failure of the Motorola product could create a situation where personal injury or death may occur. Should Buyer purchase or use Motorola products for any such unintended or unauthorized application, Buyer shall indemnify and hold Motorola and its officers, employees, subsidiaries, affiliates, and distributors harmless against all claims, costs, damages, and expenses, and reasonable attorney fees arising out of, directly or indirectly, any claim of personal injury or death associated with such unintended or unauthorized use, even if such claim alleges that Motorola was negligent regarding the design or manufacture of the part. Motorola and  are registered trademarks of Motorola, Inc. Motorola, Inc. is an Equal Opportunity/Affirmative Action Employer.

Mfax is a trademark of Motorola, Inc.

How to reach us:

USA/EUROPE/Locations Not Listed: Motorola Literature Distribution;
P.O. Box 5405, Denver, Colorado 80217. 303-675-2140 or 1-800-441-2447

JAPAN: Nippon Motorola Ltd.: SPD, Strategic Planning Office, 4-32-1,
Nishi-Gotanda, Shinagawa-ku, Tokyo 141, Japan. 81-3-5487-8488

Mfax™: RMFAX0@email.sps.mot.com – TOUCHTONE 602-244-6609
– US & Canada ONLY 1-800-774-1848

ASIA/PACIFIC: Motorola Semiconductors H.K. Ltd.; 8B Tai Ping Industrial Park,
51 Ting Kok Road, Tai Po, N.T., Hong Kong. 852-26629298

INTERNET: <http://motorola.com/sps>



MRFIC2404/D

