

The RF Line

NPN Silicon

RF Power Transistor

The TPV8200B is designed for output stages in band IV and V TV transmitter amplifiers. It incorporates high value emitter ballast resistors, gold metallizations and offers a high degree of reliability and ruggedness.

Including input and output matching networks, the TPV8200B features high impedances. It can operate over the 470 MHz to 860 MHz bandwidth using a single fixed tuned circuit.

- To be used class AB for TV band IV and V.
- Specified 28 Volts, 860 MHz Characteristics
 - Output Power = 190 Watts (peak sync.)
 - Output Power = 150 Watts (CW)
 - Gain = 8 dB Min
- Circuit board photomaster available upon request by contacting RF Tactical Marketing in Phoenix, AZ.

TPV8200B

Motorola Preferred Device

190 W, 470–860 MHz
RF POWER TRANSISTOR
NPN SILICON

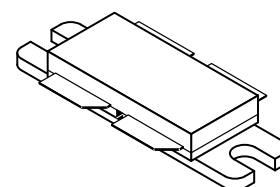

CASE 375A-01, STYLE 1

MAXIMUM RATINGS

Rating	Symbol	Value	Unit
Collector–Emitter Voltage	V_{CEO}	30	Vdc
Collector–Base Voltage	V_{CBO}	65	Vdc
Emitter–Base Voltage	V_{EBO}	4	Vdc
Collector–Current — Continuous	I_C	20	Adc
Total Device Dissipation @ $T_C = 25^\circ\text{C}$ Derate above 25°C	P_D	250 1.43	Watts W/°C
Quiescent Current (without RF drive)	I_{CQ}	2 x 500	mAdc
Storage Temperature Range	T_{stg}	-65 to +150	°C

THERMAL CHARACTERISTICS

Characteristic	Symbol	Max	Unit
Thermal Resistance, Junction to Case (1)	$R_{\theta JC}$	0.7	°C/W

ELECTRICAL CHARACTERISTICS ($T_C = 25^\circ\text{C}$ unless otherwise noted)

Characteristic	Symbol	Min	Typ	Max	Unit
----------------	--------	-----	-----	-----	------

OFF CHARACTERISTICS

Collector–Emitter Breakdown Voltage ($I_C = 20$ mAdc, $I_B = 0$)	$V_{(BR)CEO}$	30	35	—	Vdc
Collector–Base Breakdown Voltage ($I_C = 20$ mAdc, $I_E = 0$)	$V_{(BR)CBO}$	65	80	—	Vdc
Emitter–Base Breakdown Voltage ($I_E = 20$ mAdc, $I_C = 0$)	$V_{(BR)EBO}$	4	5	—	Vdc
Collector–Emitter Leakage Current ($V_{CE} = 28$ Vdc, $R_{BE} = 75 \Omega$)	I_{CER}	—	—	15	mAdc

NOTE:

1. Thermal resistance is determined under specific RF condition.

(continued)

Teflon is a registered trademark of du Pont de Nemours & Co., Inc.

Preferred devices are Motorola recommended choices for future use and best overall value.

ELECTRICAL CHARACTERISTICS — continued ($T_C = 25^\circ\text{C}$ unless otherwise noted)

Characteristic	Symbol	Min	Typ	Max	Unit
----------------	--------	-----	-----	-----	------

ON CHARACTERISTICS

DC Current Gain ($I_{CE} = 2 \text{ Adc}$, $V_{CE} = 10 \text{ Vdc}$)	h_{FE}	30	75	120	—
--	----------	----	----	-----	---

DYNAMIC CHARACTERISTICS

Output Capacitance (each side) (2) ($V_{CB} = 28 \text{ Vdc}$, $I_E = 0$, $f = 1 \text{ MHz}$)	C_{ob}	—	76	—	pF
---	----------	---	----	---	----

FUNCTIONAL TESTS IN CW

Common-Emitter Amplifier Power Gain ($V_{CE} = 28 \text{ Vdc}$, $P_{out} = 150 \text{ W}$, $I_{CQ} = 2 \times 75 \text{ mA}$, $f = 860 \text{ MHz}$)	G_{pe}	8	9.5	—	dB
Collector Efficiency ($V_{CE} = 28 \text{ Vdc}$, $P_{out} = 150 \text{ W}$, $I_{CQ} = 2 \times 75 \text{ mA}$, $f = 860 \text{ MHz}$)	η	45	53	—	%
Output Power @ 1 dB Compression ($P_{ref} = 40 \text{ W}$) ($V_{CE} = 28 \text{ Vdc}$, $I_{CQ} = 2 \times 75 \text{ mA}$, $f = 860 \text{ MHz}$)	P_{out}	150	165	—	W
Input overdrive: no degradation ($V_{CE} = 28 \text{ Vdc}$, $I_{CQ} = 2 \times 75 \text{ mA}$, $f = 860 \text{ MHz}$)	P_{in}	30	—	—	W
Output Mismatch Stress: ($V_{CE} = 28 \text{ Vdc}$, $P_{out} = 120 \text{ W}$, $I_{CQ} = 2 \times 75 \text{ mA}$, $f = 860 \text{ MHz}$, Load VSWR = 3:1, all phase angles at frequency of test)	ψ	No Degradation in Output Power Before or After Test			

FUNCTIONAL TESTS IN VIDEO (Standard Black Level)

Peak Output Power @ 1 dB Compression ($V_{CE} = 28 \text{ Vdc}$, $I_{CQ} = 2 \times 75 \text{ mA}$, $f = 860 \text{ MHz}$)	P_{out}	190	210	—	W
---	-----------	-----	-----	---	---

NOTE:

2. Value of " C_{ob} " is that of die only. It is not measurable in TPV8200B because of internal matching network.

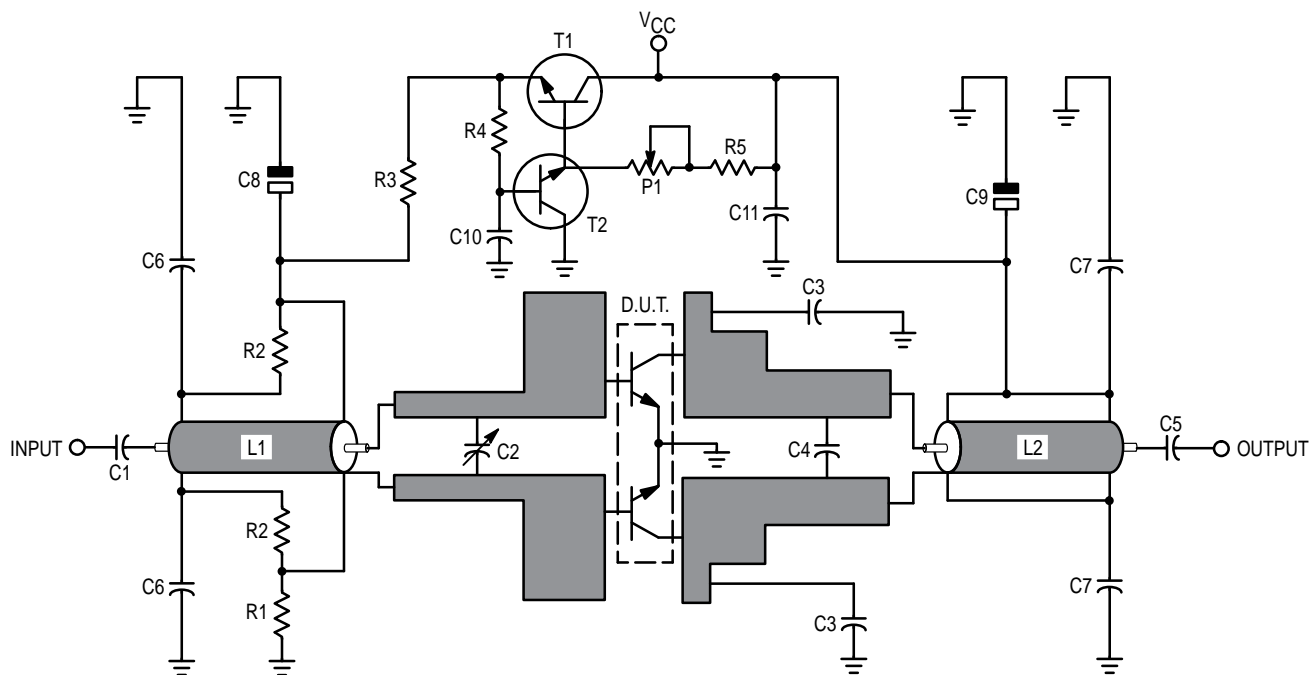

- | | | |
|--|---|---|
| C1 — Chip Capacitor 47 pF ATC 100A | C8 — Capacitor 220 $\mu\text{F}/16 \text{ V}$ | R3 — Resistor 0.8 Ω |
| C2 — Chip Capacitor 12 pF ATC 100B
+ Trimmer Capacitor 0.5–4 pF | C9 — Capacitor 100 $\mu\text{F}/40 \text{ V}$ | R4 — Resistor 47 Ω |
| C3 — Chip Capacitor 8.2 pF ATC 100B | C10 — Chip Capacitor 100 pF Vitramon | R5 — Resistor 1.2 k Ω |
| C4 — Chip Capacitor 12 pF ATC 100B | C11 — Chip Capacitor 15 nF Vitramon | P1 — Trimmer Resistor 5 k Ω |
| C5 — Chip Capacitor 100 pF ATC 100A | L1 — Coaxial 25 Ω /length = 41 mm | T1 — Transistor BD 135 |
| C6 — Chip Capacitor 2 x 1000 pF Vitramon | L2 — Coaxial 25 Ω /length = 41 mm | T2 — Transistor BD 135 |
| C7 — Chip Capacitor 2 x 0.1 μF Vitramon | R1 — Chip Resistor 47 Ω | PC Board: 1/50" Glass Teflon [®] $\epsilon_r = 2.55$ |
| | R2 — 2 x 1 Ω (0.5 Ω) | |

Figure 1. 860 MHz Test Circuit

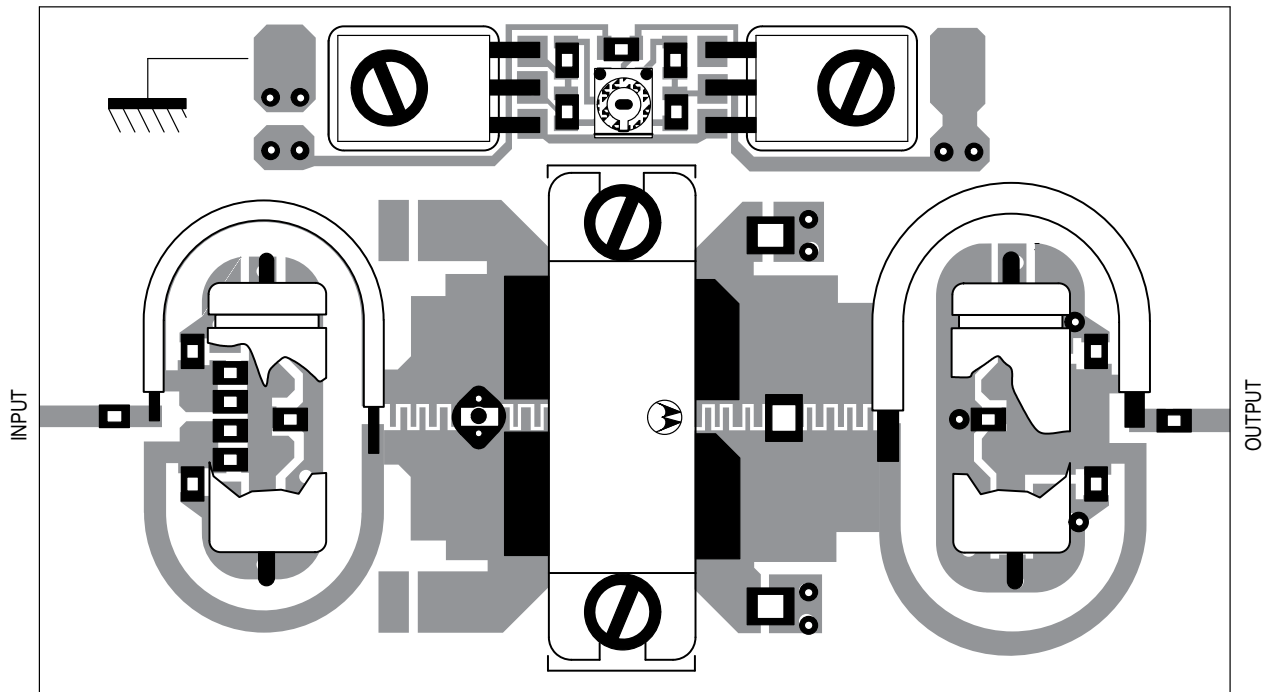

Figure 2. Components View

CAUTION

The TPV8200B is a high power transistor and thermal adaptation is very important for good RF performance (see mechanical drawing for mounting recommendations).

Maximum Ratings are given to avoid destruction of the transistor; another limitation is MMTBF and the user must first determine the minimum wanted life-time in order to choose the right way of use for the device (see MMTBF curves), especially in case of CW application.

TYPICAL CHARACTERISTICS

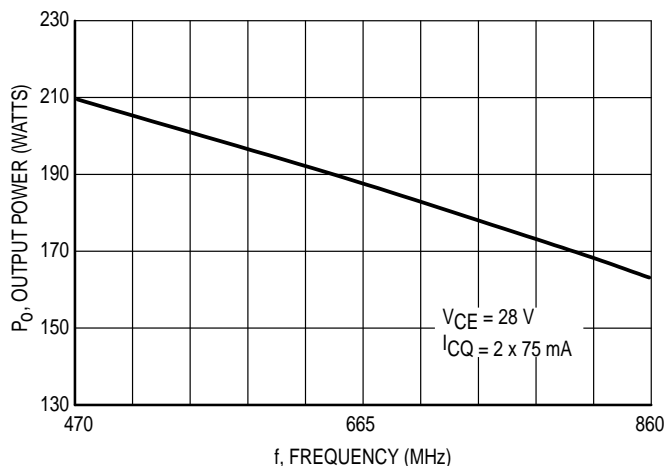

Figure 3. Output Power @ 1 dB Comp. versus Frequency

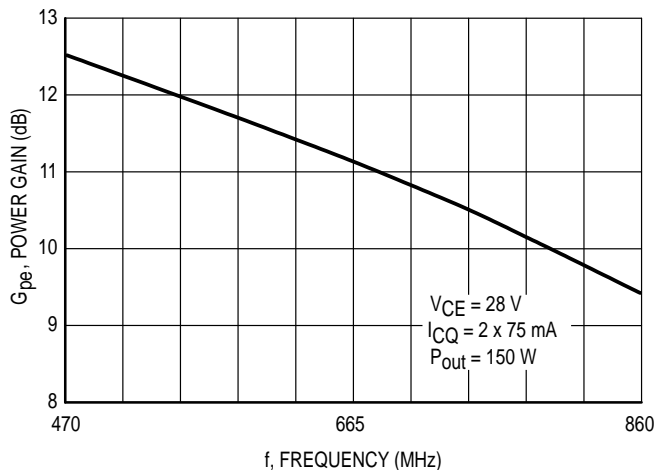

Figure 4. Power Gain versus Frequency

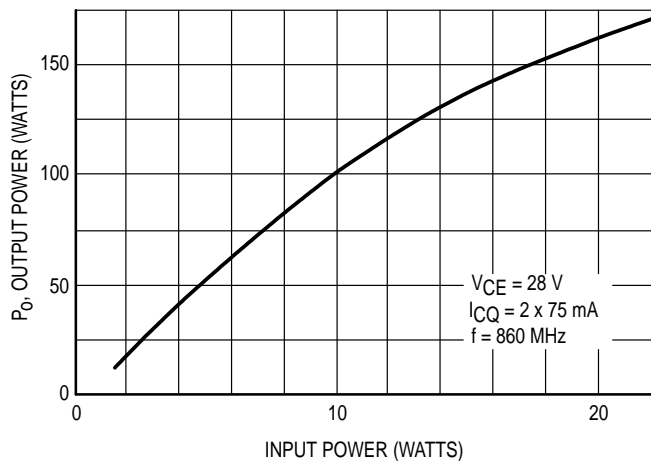

Figure 5. Output Power versus Input Power

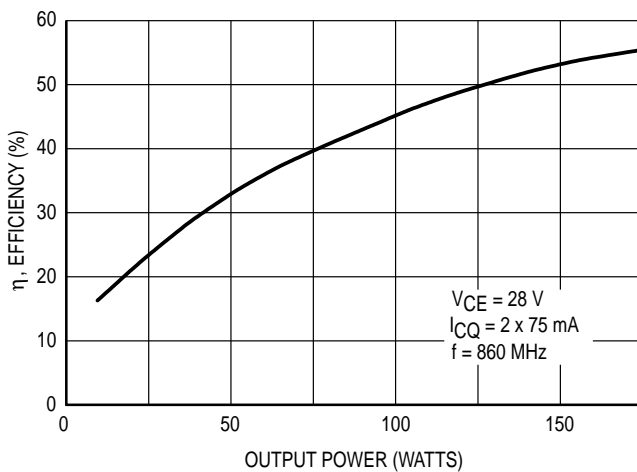

Figure 6. Collector Efficiency versus Output Power

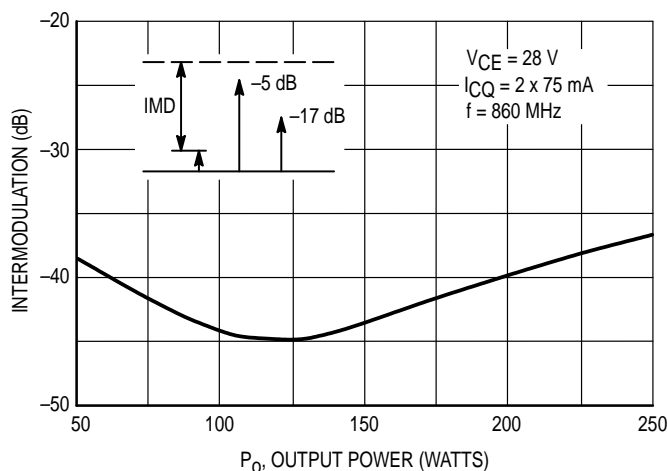

Figure 7. Intermodulation versus Peak Power (Side Band)

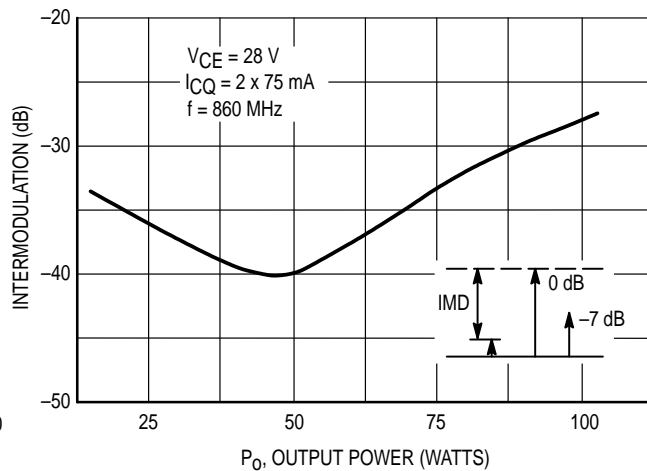

Figure 8. Intermodulation versus Peak Power (Dual Sound)

TYPICAL VIDEO CHARACTERISTICS @ f = 860 MHz
V_{CE} = 28 V

V_{CE} = 28 V
 I_{CQ} = 2 x 75 mA
 f = 860 MHz
 (Channel 69)
 Black Level

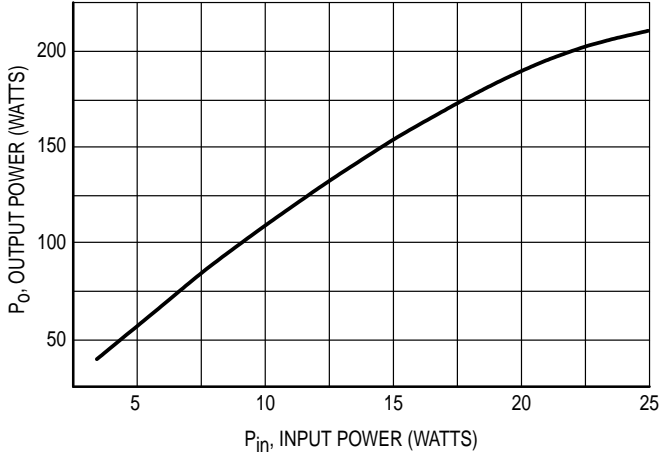
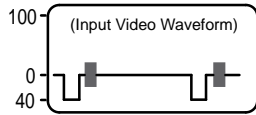

Figure 9. Peak Output Power versus Peak Input Power

V_{CE} = 28 V
 I_{CQ} = 2 x 75 mA
 f = 860 MHz
 (Channel 69)
 Black Level

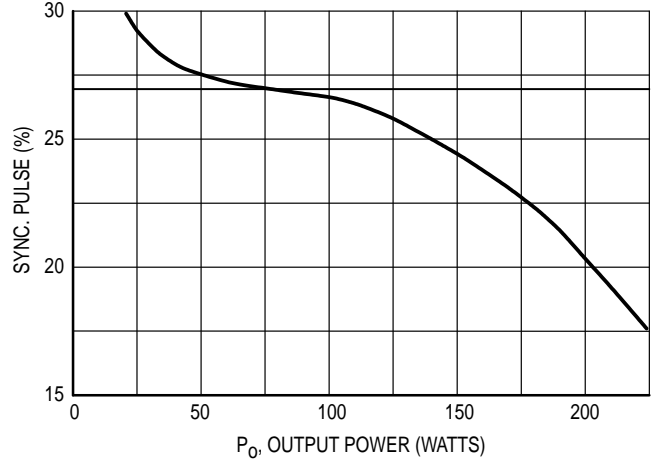
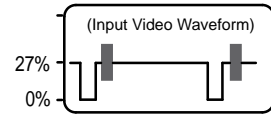

Figure 10. Sync. Pulse versus Peak Output Power

TEST CONDITIONS:
 10% Rest Carrier
 Channel 69
 V_{CE} = 28 V
 I_{CQ} = 2 x 75 mA

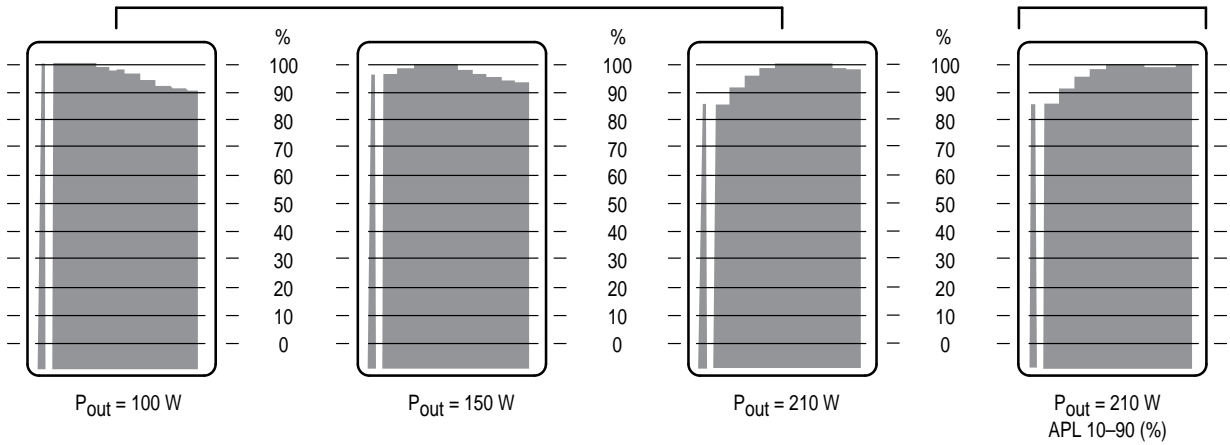
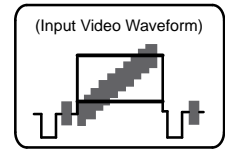
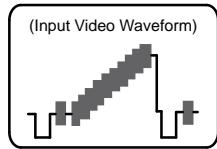
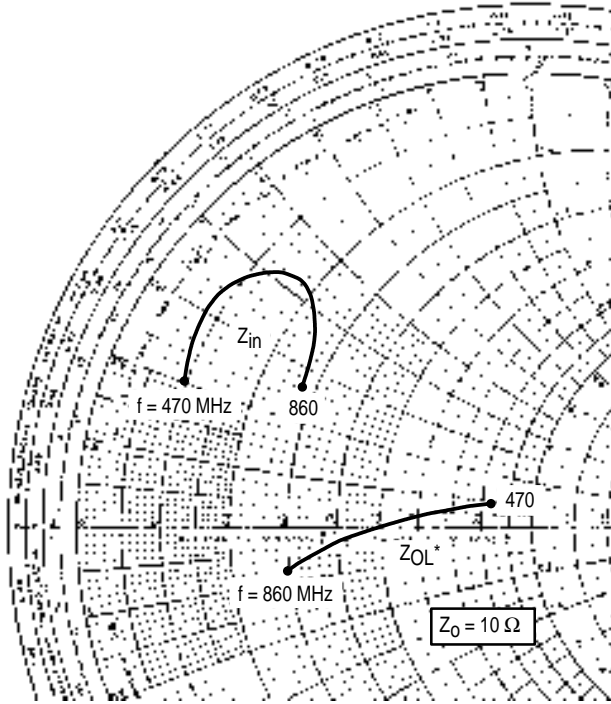

Figure 11. Gain versus Output Power



f MHz	Z _{in} Ohms	Z _{OL*} Ohms
470	0.80 + j2.11	7.93 + j0.94
567	0.85 + j3.15	5.94 + j0.30
665	1.56 + j4.20	4.55 - j0.02
762	2.64 + j3.36	3.70 - j0.52
860	2.72 + j2.24	2.91 - j0.92

Z_{OL*} = Conjugate of optimum load impedance into which the device operates at a given output power, voltage, current, and frequency.

Base-base & collector-collector Impedances with
Circuit Tuned for Maximum Gain @ V_{CE} = 28 V / I_{CQ} = 2 x 75 mA / P_{out} = 150 W

Figure 12. Series Equivalent Input/Output Impedances

RELIABILITY DEPENDENCE ON THERMAL CONSIDERATIONS

MMMTBF: Metal Migration Mean Time Before Failure.

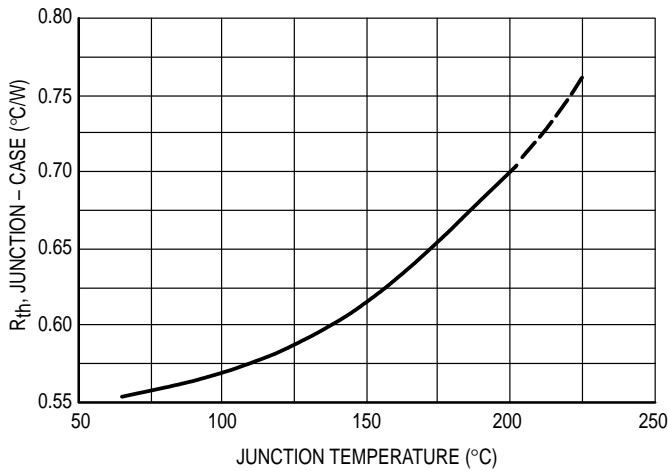

Figure 13. Thermal Resistance versus Junction Temperature

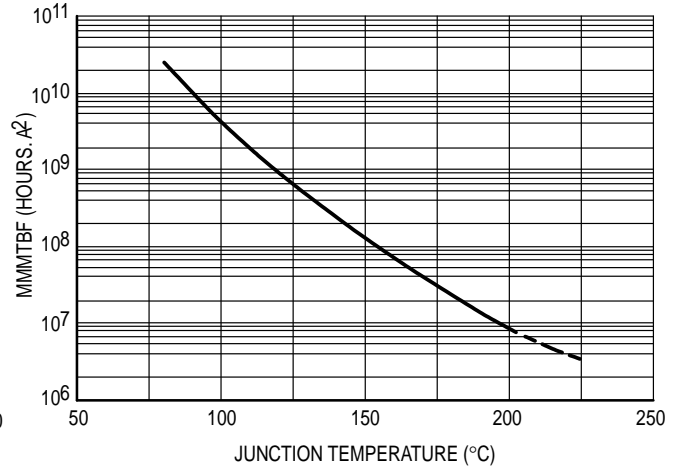
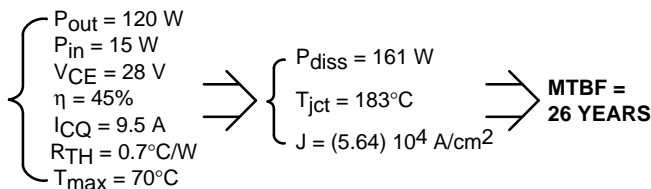
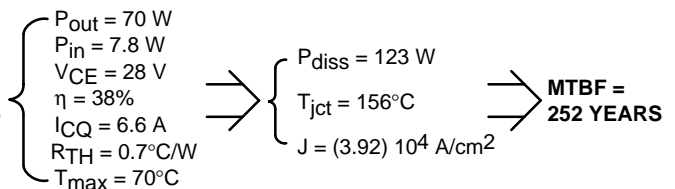

Figure 14. MMMTBF versus Junction Temperature

TYPICAL CONDITIONS (120 W CW):



TYPICAL CONDITIONS (210 W VIDEO):



PACKAGE DIMENSIONS

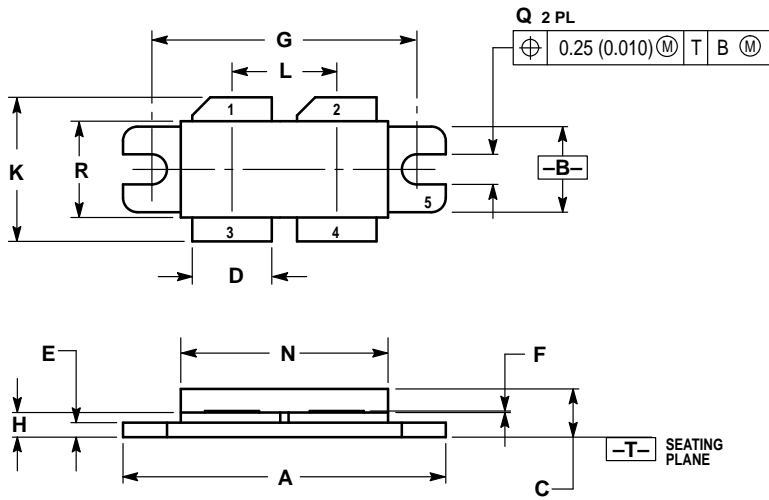

- NOTES:
 1. DIMENSIONING AND TOLERANCING PER ANSI Y14.5M, 1982.
 2. CONTROLLING DIMENSION: INCH.

DIM	INCHES		MILLIMETERS	
	MIN	MAX	MIN	MAX
A	1.330	1.350	33.79	34.29
B	0.375	0.395	9.52	10.03
C	0.180	0.205	4.57	5.21
D	0.320	0.340	8.13	8.64
E	0.060	0.070	1.52	1.77
F	0.004	0.006	0.11	0.15
G	1.100 BSC		27.94 BSC	
H	0.082	0.097	2.08	2.46
K	0.580	0.620	14.73	15.75
L	0.435 BSC		11.05 BSC	
N	0.845	0.875	21.46	22.23
Q	0.118	0.130	3.00	3.30
R	0.390	0.410	9.91	10.41

- STYLE 1:
 PIN 1. COLLECTOR
 2. COLLECTOR
 3. BASE
 4. BASE
 5. EMITTER

**CASE 375A-01
 ISSUE O**

Motorola reserves the right to make changes without further notice to any products herein. Motorola makes no warranty, representation or guarantee regarding the suitability of its products for any particular purpose, nor does Motorola assume any liability arising out of the application or use of any product or circuit, and specifically disclaims any and all liability, including without limitation consequential or incidental damages. "Typical" parameters can and do vary in different applications. All operating parameters, including "Typicals" must be validated for each customer application by customer's technical experts. Motorola does not convey any license under its patent rights nor the rights of others. Motorola products are not designed, intended, or authorized for use as components in systems intended for surgical implant into the body, or other applications intended to support or sustain life, or for any other application in which the failure of the Motorola product could create a situation where personal injury or death may occur. Should Buyer purchase or use Motorola products for any such unintended or unauthorized application, Buyer shall indemnify and hold Motorola and its officers, employees, subsidiaries, affiliates, and distributors harmless against all claims, costs, damages, and expenses, and reasonable attorney fees arising out of, directly or indirectly, any claim of personal injury or death associated with such unintended or unauthorized use, even if such claim alleges that Motorola was negligent regarding the design or manufacture of the part. Motorola and  are registered trademarks of Motorola, Inc. Motorola, Inc. is an Equal Opportunity/Affirmative Action Employer.

Literature Distribution Centers:

USA: Motorola Literature Distribution; P.O. Box 20912; Phoenix, Arizona 85036.

EUROPE: Motorola Ltd.; European Literature Centre; 88 Tanners Drive, Blakelands, Milton Keynes, MK14 5BP, England.

JAPAN: Nippon Motorola Ltd.; 4-32-1, Nishi-Gotanda, Shinagawa-ku, Tokyo 141, Japan.

ASIA PACIFIC: Motorola Semiconductors H.K. Ltd.; Silicon Harbour Center, No. 2 Dai King Street, Tai Po Industrial Estate, Tai Po, N.T., Hong Kong.



TPV8200B/D

