

### DESCRIPTION

**RangeMAX™ Wide Range Dimming, Single Output Inverter.** The LXM1615 series of Direct Drive CCFL (Cold Cathode Fluorescent Lamp) Inverter Modules are specifically designed for driving 8.4" and smaller LCD backlight lamps. They also target portable displays that rely on a single lithium-ion battery.

LXM1615 modules provide the designer with a vastly superior display brightness range. This brightness range is achievable with virtually any LCD display.

**RangeMAX Digital Dimming Technique.** Digital dimming provides flicker-free brightness control in any wide range (100:1+) dimming application. The modules are available with a dimming input that permits brightness control from either a DC voltage source or a PWM signal.

The resultant "burst drive" that energizes the lamp was designed specifically to ensure that no premature lamp degradation occurs (See the "How RangeMAX Works" section).

**V<sub>BATT</sub> Voltage Range.** The modules convert the DC voltage from a single lithium-ion battery (3.2-4.2V) or a fixed 5V supply directly to high-frequency, high-voltage waves required to ignite and operate CCFL lamps.

**Direct Drive Technology.** The module design is based on a new Direct Drive topology, which provides a number of cost and performance advantages.

**Additional Features.** Other benefits of this new topology are fixed-frequency operation, secondary-side strike-voltage regulation and both open and shorted lamp protection.

### KEY FEATURES

- RangeMAX Wide Range Dimming
- V<sub>BATT</sub> – Single Li-Ion Cell Operation Or Fixed 5V
- Easy to Use Brightness Control
- Output Short-Circuit Protection and Automatic Strike-Voltage Regulation
- Fixed Frequency Operation

### APPLICATIONS

- PDA And Sub-Notebook Computers
- Portable Instrumentation
- Target 8.4" And Smaller Panels

### BENEFITS

- Smooth, Flicker Free 1-100% Full-Range Brightness Control
- Output Open Circuit Voltage Regulation Minimizes Corona Discharge For High Reliability
- Power Efficient, "Low Brightness" Capability Allows For Advanced Power Management

**IMPORTANT:** For the most current data, consult MICROSEMI's website: <http://www.microsemi.com>

### PRODUCT HIGHLIGHT

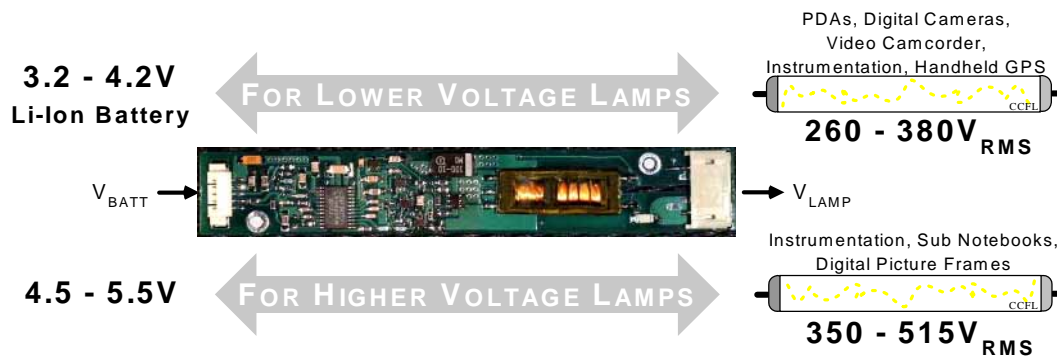

ONE INVERTER SUPPORTS EITHER VOLTAGE RANGE

### MODULE ORDER INFO

PART NUMBER	OUTPUT CONNECTOR	INVERTER MATES DIRECTLY TO PANEL CONNECTORS
LXM1615-03-01	JST SM02(8.0)B-BHS-1-TB	BHR-03VS-1
LXM1615-03-02	JST SM02B-BHSS-1-TB	BHSR-02VS-1
LXM1615-03-03	Honda QZ-19-A3MYL #02	QZ-19-3F01
LXM1615-03-04	JST SM02(4.0)B-BHS-1-TB	BHR-02VS-1



# LINFINITY

A MICROSEMI COMPANY

## RangeMAX™

## LXM1615-03-xx

3.6/5V 2W, DIGITAL DIMMING CCFL INVERTER MODULE

PRELIMINARY DATA SHEET

### ABSOLUTE MAXIMUM RATINGS

Input Supply Voltage ( $V_{BATT}$ ).....	-0.3V to 6.5V
Input Supply Voltage 3.3V (+3.3).....	-0.3V to 5.5V
Output Voltage, no load.....	Internally Limited to 1800V <sub>RMS</sub>
Output Current.....	4.5mA <sub>RMS</sub> (Internally Limited)
Output Power.....	2.1W
Input Signal Voltage (BRITE Input).....	-0.3V to 3.3V +0.3V
Input Signal Voltage (SYNC).....	-0.3V to 3.3V +0.3V
Ambient Operating Temperature, zero airflow.....	0°C to 70°C
Storage Temperature Range.....	-40°C to 85°C

Note: Exceeding these ratings could cause damage to the device. All voltages are with respect to Ground. Currents are positive into, negative out of specified terminal.

### RECOMMENDED OPERATING CONDITIONS

This module has been designed to operate over a wide range of input and output conditions. However, best efficiency and performance will be obtained if the module is operated under the condition listed in the 'R.C.' Column. Min. and Max. columns indicate values beyond which the inverter, although operational, will not function optimally.

Parameter	Symbol	Recommended Operating Conditions			Units
		Min	R.C.	Max	
Input Supply Voltage (+3.3V)	+3.3	3.1	3.3	3.5	V
$V_{BATT}$ Voltage Range ( $V_{BATT} = 3.6V$ )	$V_{BATT}$	3.2	3.6	4.2	V
$V_{BATT}$ Voltage Range ( $V_{BATT} = 5.0V$ )	$V_{BATT}$	4.5	5.0	5.5	V
Output Power ( $V_{BATT} = 3.6V$ )	$P_O$	1	1.2	1.5	W
Output Power ( $V_{BATT} = 5.0V$ )	$P_O$	1.5	1.7	2	W
Brightness Control Input Voltage Range	$V_{BRT\_ADJ}$	0.0		2.2	V
Lamp Operating Voltage ( $V_{BATT} = 3.6V$ )	$V_{LAMP}$	260	305	380	V <sub>RMS</sub>
Lamp Operating Voltage ( $V_{BATT} = 5.0V$ )	$V_{LAMP}$	350	445	515	V <sub>RMS</sub>
Lamp Current (Full Brightness)	$I_{OLAMP}$		4.0		mA <sub>RMS</sub>
Operating Ambient Temperature Range	$T_A$	0		70	°C

### ELECTRICAL CHARACTERISTICS

Unless otherwise specified, these specifications apply over the recommended operating conditions and 25°C ambient temperature for the LXM1615-03-xx.

Parameter	Symbol	Test Conditions	LXM1615-03-xx			Units
			Min	Typ	Max	
<b>▶ OUTPUT PIN CHARACTERISTICS</b>						
Full Bright Lamp Current	$I_{L(MAX)}$	$V_{BRT\_ADJ} = 0V, V_{BATT} = 3.6V$ or 5V	3.5	4.0	4.5	mA <sub>RMS</sub>
Min. Average Lamp Current (Note 2)	$I_{L(MIN)}$	$V_{BRT\_ADJ} = 2.2V_{DC}, V_{BATT} = 3.6V$ or 5V		.08		mA <sub>RMS</sub>
Lamp Start Voltage	$V_{LS}$	$V_{BATT} = 3.2 - 4.2V$ or 4.5V to 5.5V	1250	1400	1800	V <sub>RMS</sub>
Operating Frequency	$F_O$	$V_{BRT\_ADJ} = 0V_{DC}$	80	90	100	KHz
<b>▶ BRITE INPUT</b>						
Linear Dim Control Range	$V_{BRT}$		.25		2.2	V <sub>DC</sub>
Input Current	$I_{BRT}$	$V_{BRT\_ADJ} = 0V_{DC}$	-21	-27	-41	μA <sub>DC</sub>
		$V_{BRT\_ADJ} = 2.5V_{DC}$	250	268	290	μA <sub>DC</sub>
Input Voltage for Max. Lamp Current	$V_{BRT\_ADJ}$	$I_{O(LAMP)} = 100\%$ Duty Cycle	0		.25	V <sub>DC</sub>
Input Voltage for Min. Lamp Current	$V_{BRT\_ADJ}$	$I_{O(LAMP)} = \text{Minimum Duty Cycle}$	2.2		2.5	V <sub>DC</sub>
<b>▶ +3.3V</b>						
RUN Mode	ENABLE	+3.3V = High	3.1	3.3	3.5	V <sub>DC</sub>
OFF Mode	DISABLE	+3.3V = Low	-0.3	0.0	2.7	V <sub>DC</sub>
Input Current	$I_{INRUN}$	+3.3V ± 5%		10	20	mA
	$I_{INPK}$			100		
<b>▶ VSYNC CHARACTERISTICS</b>						
Logic High Threshold	$V_{SYNC(HI)}$	+3.3V = 3.3V ± 5%	2.2			V <sub>DC</sub>
Logic Low Threshold	$V_{SYNC(LO)}$	+3.3V = 3.3V ± 5%			.8	V <sub>DC</sub>
Input Impedance	$Z_{IN}$			10		KΩ
Input Frequency	$FV_{SYNC}$		45		400	Hz
Free Run Frequency	$F_{BURST}$	Output Burst Rate; $V_{SYNC} = 0V$		530		Hz

#### ELECTRICAL CHARACTERISTICS (CONTINUED)

Unless otherwise specified, these specifications apply over the recommended operating conditions and 25°C ambient temperature for the LXM1615-03-xx.

Parameter	Symbol	Test Conditions	LXM1615-03-xx			Units
			Min	Typ	Max	
<b>POWER CHARACTERISTICS</b>						
Run Current	$V_{BATT} = 3.6V_{DC}$	$V_{BRT\_ADJ} = 0V, V_{LAMP} = 270V_{RMS}$		360		mA
Run Current	$V_{BATT} = 5.0V_{DC}$	$V_{BRT\_ADJ} = 0V, V_{LAMP} = 420V_{RMS}$		405		mA

Note 2: Minimum lamp current required to maintain even light output may vary with display panel.  
Average RMS current = (burst duty cycle) × (burst amplitude of 4.0mA<sub>RMS</sub>)

#### FUNCTIONAL PIN DESCRIPTION

Conn.	Pin	Description
<b>CN1 (Molex 53261-0590)*</b>		
CN1-1	$V_{BATT}$	Main Input Power Supply (3.2V to 5.5V)
CN1-2	GND	Power Supply Return
CN1-3	+3.3V	+3.3V Logic Input
CN1-4	BRITE	Brightness Control (0.25- 2.2VDC) 0.25VDC gives maximum lamp current
CN1-5	$V_{SYNC}$	Vertical Synchronization Input 3.3V Logic Level ( $45 < f_{SYNC} < 400Hz$ )
<b>CN2 for LXM1615-03-01,-02,-04 (JST SM02(8.0)B-BHS-1-TB, SM02B-BHSS-1-TB, or SM02(4.0)B-BHS-1-TB)</b>		
CN2-1	$V_{HI}$	High Voltage Connection to High Side of Lamp. Connect to lamp terminal with shortest lead length. <b>DO NOT</b> connect to Ground.
CN2-2	$V_{LO}$	Connection to Low Side of Lamp. Connect to lamp terminal with longer lead length. <b>DO NOT</b> connect to Ground.
<b>CN2 for LXM1615-03-03 (Honda QZ-19-AMYL#02)</b>		
CN2-3	$V_{HI}$	High Voltage Connection to High Side of Lamp. Connect to lamp terminal with shortest lead length. <b>DO NOT</b> connect to Ground.
CN2-1	$V_{LO}$	Connection to Lower Side of Lamp. Connect to lamp terminal with longer lead length. <b>DO NOT</b> connect to Ground.

\* LX9506 Mating Connector Assembly Available

#### PHYSICAL DIMENSIONS

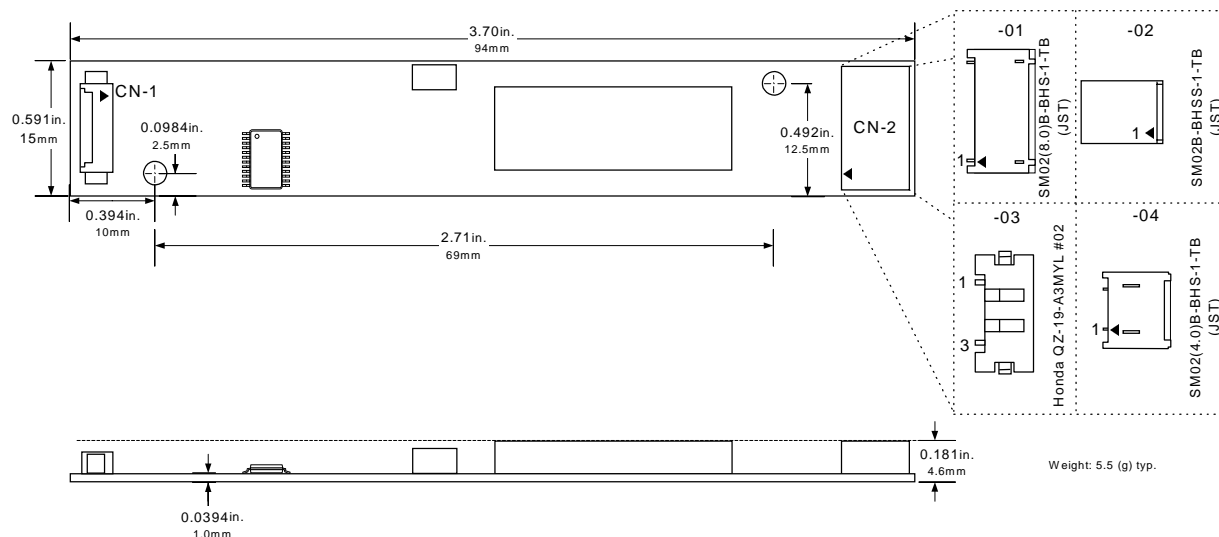

## HOW THE RANGEMAX WORKS

### LAMP VOLTAGE & LAMP CURRENT – BURST MODE OPERATION

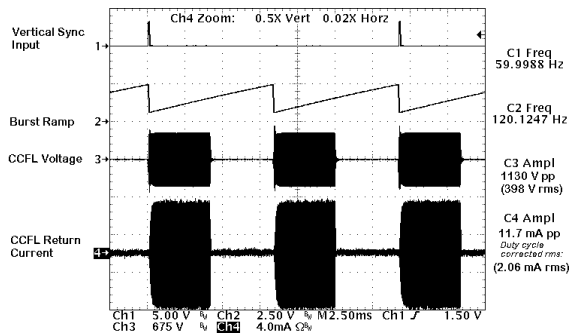

**Figure 1 – 50% Burst Duty Cycle**

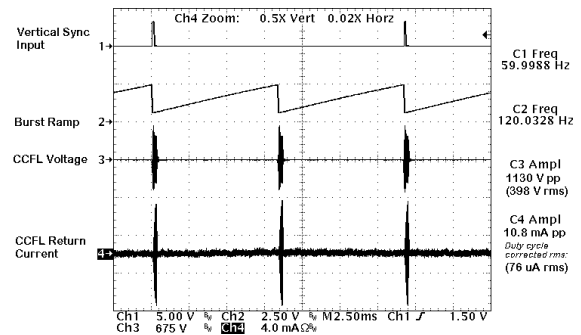
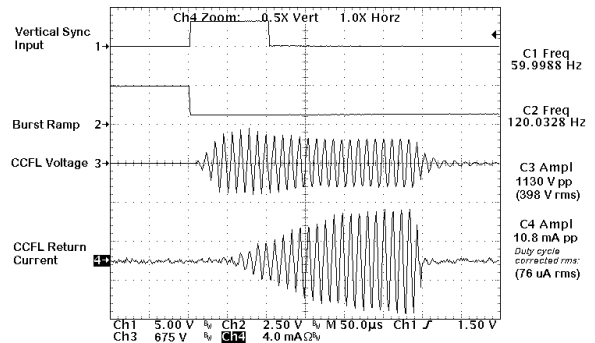

**Figure 2 – 2% Burst Duty Cycle**

Rather than using the traditional dimming technique of varying lamp current magnitude to adjust light output, RangeMAX inverters use a fixed lamp current value with a duty cycle control method.

The lamp current burst width can be modulated from 100% (continuous lamp current) down to a 2% duty cycle, allowing the lamp to be dimmed to less than 1% of its full brightness.

As can be seen in Trace 4 of Figure 3 photo at right, careful design consideration was given to controlling lamp start voltage to softly start current flow. This eliminates current overshoot that can result in premature cathode wear and reduce lamp life.



**Figure 3 – 2% Burst Duty Cycle (Expanded Time Base)**

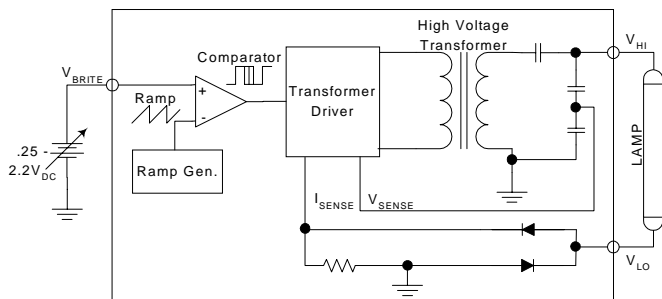

**Figure 4 – RangeMAX Simplified Block Diagram**

### HIGHLIGHTS

- Integrated brightness control circuit includes a DC voltage to pulse width converter that minimizes system design work and system noise susceptibility. This provides a familiar and convenient interface while reducing the potential for externally induced noise, which can cause lamp flicker.
- RangeMAX inverter modules are designed to operate with the burst frequency synchronized to the video frame rate. This provides operation with no visible display disturbances caused by beat frequencies between the lamps and video frame rates. In this synchronous mode, the inverter burst rate operates at twice the video refresh rate, well beyond standard 50/60Hz video refresh rates where the eye can perceive pulsing light.
- In applications with no access to a vertical sync, an onboard oscillator operates the inverter burst rate at about 500Hz. In this non-synchronous mode, minor display disturbances can be found under certain video conditions. This performance may be acceptable for many applications, but synchronization must be used when no disturbance can be tolerated.

### HOW THE RANGEMAX WORKS (CONTINUED)

#### HIGHLIGHTS (CONTINUED)

- Separate feedback loops for lamp current and open circuit voltage regulation insure reliable strike under all operating conditions, automatic over-voltage prevention with broken or failed lamps, and accurate lamp current regulation.
- A single input will accommodate negative and positive vertical sync pulses at any pulse width.

### TYPICAL APPLICATION

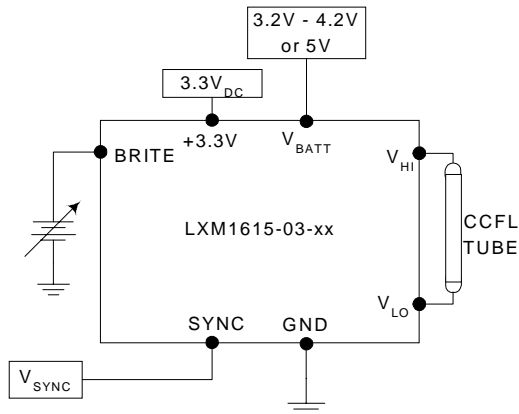

Figure 5 - Brightness Control

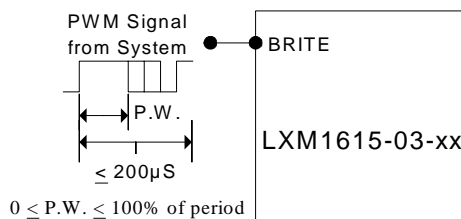

Figure 5A - PWM Brightness Control

- The Brightness control may be a voltage output DAC, or other voltage source as shown in Figure 5. A 3.3V Logic Level PWM signal from a micro-controller may also be used as shown in Figure 5A.
- If synchronization to the video frame rate is desired, connect the vertical sync pulse from the system video controller to the VSYNC input. If no video synchronization is desired, connect VSYNC to ground.
- If you need to turn the inverter ON/OFF remotely, use the +3.3V Logic Supply pin.
- Connect VHI to high voltage wire from the lamp. Connect VLO to the low voltage wire (wire with thinner insulation). Never connect VLO to circuit ground as this will defeat lamp current regulation. If both lamp wires have heavy high voltage insulation, connect the longest wire to VLO. This wire is typically white.

### RangeMAX INVERTERS

Also available in higher power single lamp inverters LXM1612-xx-xx, Dual Output LXM1621-01, LXM1622-xx-xx and Quad Output LXM1641-01 versions for multiple lamp applications.

### LXM1615-03-XX OUTPUT CURRENT ADJUST

The LXM1615-03-xx output current can be adjusted lower by changing the value of one resistor (R10) on the PCB. The following table shows the new output current values:

4.0mArms	137K 1% (stock setting)
3.5mArms	95.3K1%
3.0mArms	68.1K1%
2.5mArms	49.9K1%
2.0mArms	36.5K1%

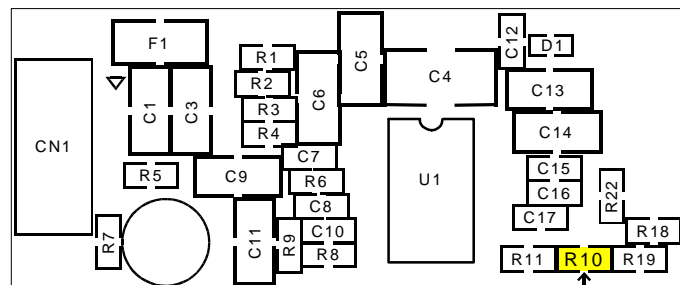

Preliminary Data – Information contained in this document is pre-production data and is proprietary to Linfinity. It may not be modified in any way without the express written consent of Linfinity. Product referred to herein is offered in sample form only and Linfinity reserves the right to change or discontinue this proposed product at any time.