

Schottky Rectifier

SBT2535 – SBT2545

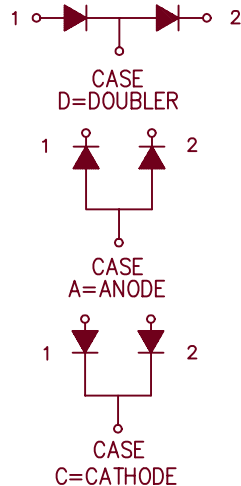
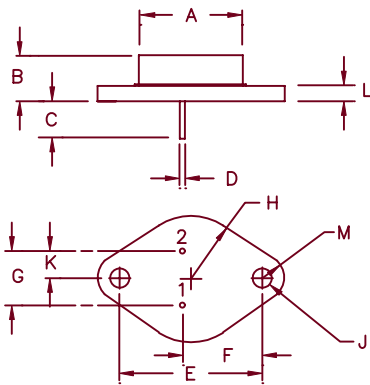

Dim.	Inches		Millimeter		Notes
	Minimum	Maximum	Minimum	Maximum	
A	—	.875	—	22.23	Dia.
B	.250	.450	6.35	11.43	
C	.435	—	11.05	—	
D	.038	.043	.97	1.09	Dia.
E	1.177	1.197	29.90	30.40	
F	.655	.675	16.64	17.15	
G	.420	.440	10.67	11.18	
H	—	.525	—	13.34	Rad.
J	.151	.161	3.84	4.09	Dia.
K	.205	.225	5.21	5.72	
L	—	.135	—	3.43	
M	—	.188	—	4.78	Rad.

TO-204AA (TO-3)

Microsemi Catalog Number	Working Peak Reverse Voltage	Repetitive Peak Reverse Voltage
SBT2535*	35V	35V
SBT2540*	40V	40V
SBT2545*	45V	45V

*ADD D, C, or A

- Schottky Barrier Rectifier
- Guard Ring Protection
- Low Forward Voltage
- VRRM – 35 to 45V
- 25 Amperes
- Reverse Energy Tested

Electrical Characteristics Per Leg

Average forward current (standard)	I _{F(AV)} 25 Amps	T _C = 115°C, Square wave, R _{θJC} = 1.4°C/W
Average forward current (reverse)	I _{F(AV)} 25 Amps	T _C = 92°C, Square wave, R _{θJC} = 2.2°C/W
Maximum surge current	I _{FSM} 600 Amps	8.3 ms, half sine T _J = 150°C
Max repetitive peak reverse current	I _{R(OV)} 2 Amps	f = 1 KHz, 25°C, 1 μsec Square wave
Max peak forward voltage	V _{FM} .53 Volts	I _{FM} = 25A: T _J = 150°C*
Max peak forward voltage	V _{FM} .58 Volts	I _{FM} = 25A: T _J = 25°C*
Max peak reverse current	I _{RM} 250 mA	V _{RRM} , T _J = 125°C*
Max peak reverse current	I _{RM} 2 mA	V _{RRM} , T _J = 25°C
Typical junction capacitance per leg	C _J 1200 pF	V _R = 5.0V, T _J = 25°C

*Pulse test: Pulse width 300 μsec, Duty cycle 2%

Thermal and Mechanical Characteristics

Storage temp range	T _{STG}	-65°C to 175°C
Operating junction temp range	T _J	-65°C to 150°C
Maximum thermal resistance (standard polarity)	R _{θJC}	1.4°C/W Junction to case
Maximum thermal resistance (reverse polarity)	R _{θJC}	2.2°C/W Junction to case
Typical thermal resistance (greased)	R _{θCS}	0.5°C/W Case to sink
Weight		1.0 ounces (28 grams) typical

SBT2535 — SBT2545

Figure 1
Typical Forward Characteristics

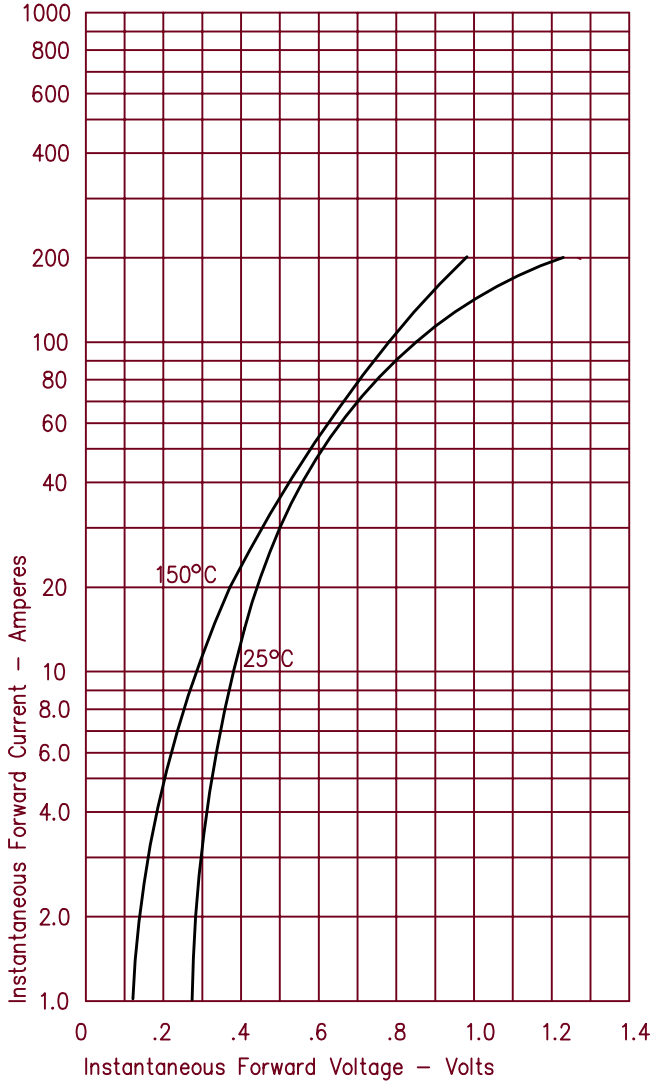

Figure 3
Typical Junction Capacitance

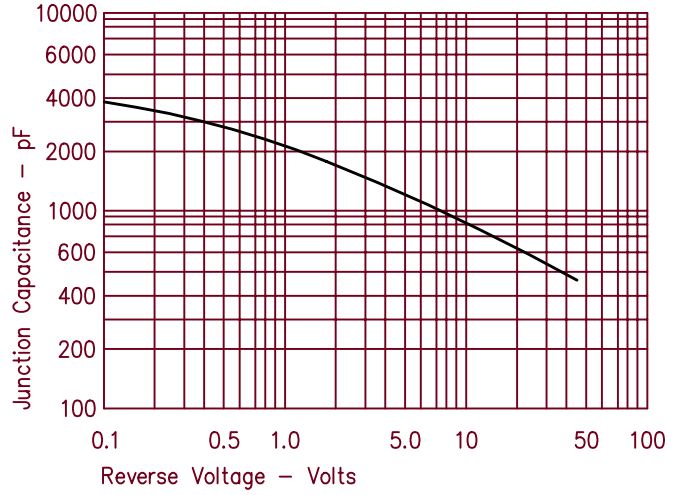

Figure 4
Forward Current Derating - Standard Polarity

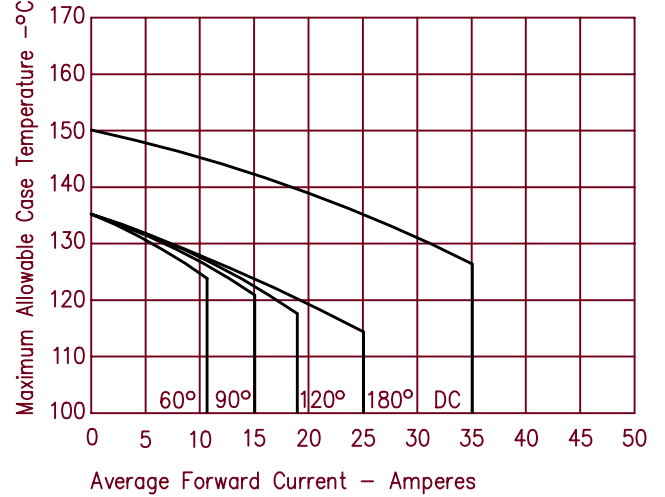

Figure 2
Typical Reverse Characteristics

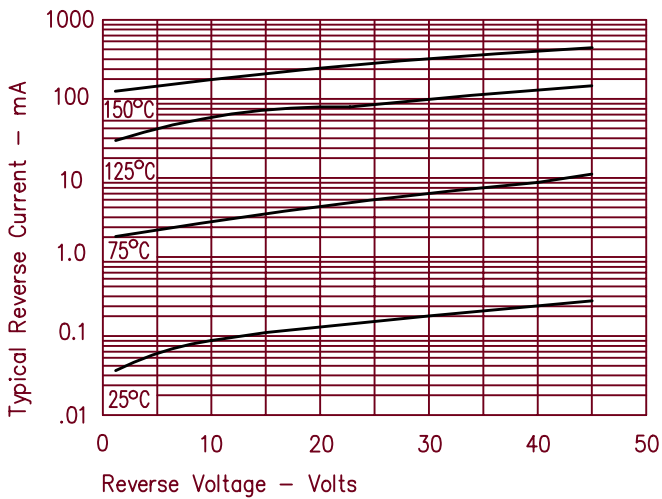
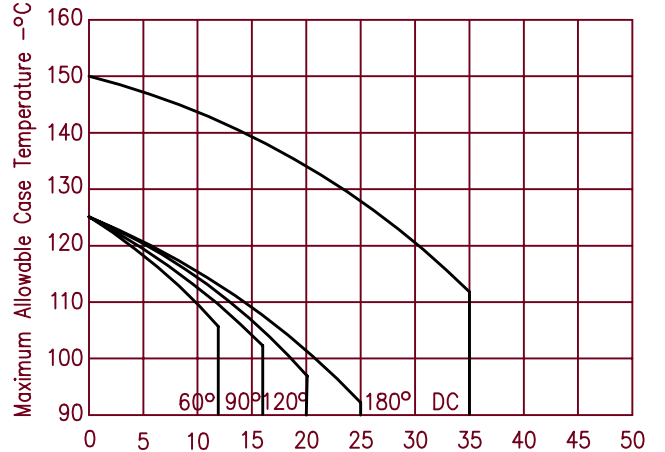

Figure 5
Forward Current Derating - Reverse Polarity



SBT2535 – SBT2545

Figure 6
Maximum Forward Power Dissipation – Standard Polarity

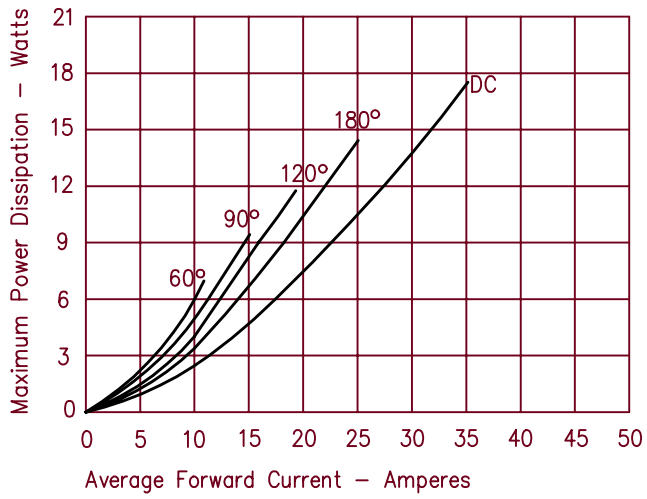

Figure 7
Maximum Forward Power Dissipation – Reverse Polarity

