

# Schottky Rectifier

## SBT3040 — SBT3050

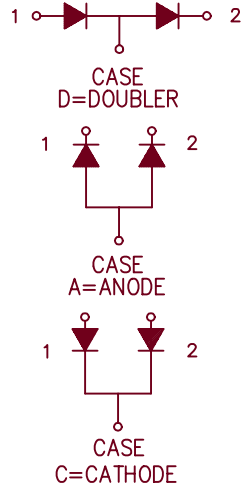
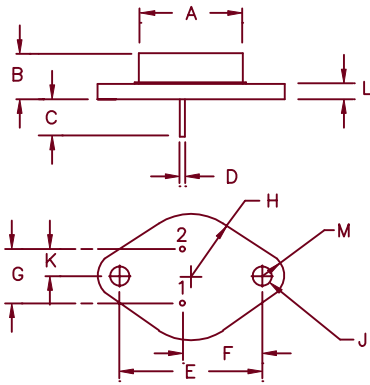

Dim.	Inches		Millimeter		Notes
	Minimum	Maximum	Minimum	Maximum	
A	—	.875	—	22.23	Dia.
B	.250	.450	6.35	11.43	
C	.435	—	11.05	—	
D	.038	.043	.97	1.09	Dia.
E	1.177	1.197	29.90	30.40	
F	.655	.675	16.64	17.15	
G	.420	.440	10.67	11.18	
H	—	.525	—	13.34	Rad.
J	.151	.161	3.84	4.09	Dia.
K	.205	.225	5.21	5.72	
L	—	.135	—	3.43	
M	—	.188	—	4.78	Rad.

TO-204AA (TO-3)

Microsemi Catalog Number	Working Peak Reverse Voltage	Repetitive Peak Reverse Voltage
SBT3040*	40V	40V
SBT3045*	45V	45V
SBT3050*	50V	50V

\*ADD D, C, or A

- Schottky Barrier Rectifier
- Guard Ring Protection
- Low Forward Voltage
- VRRM — 40 to 50V
- 30 Amperes
- Reverse Energy Tested

### Electrical Characteristics Per Leg

Average forward current (standard)	$I_F(AV)$ 30 Amps	$T_C = 148^\circ C$ , Square wave, $R_{\theta JC} = 1.4^\circ C/W$
Average forward current (reverse)	$I_F(AV)$ 30 Amps	$T_C = 132^\circ C$ , Square wave, $R_{\theta JC} = 2.2^\circ C/W$
Maximum surge current	$I_{FSM}$ 600 Amps	8.3 ms, half sine $T_J = 175^\circ C$
Max repetitive peak reverse current	$I_R(OV)$ 2 Amps	$f = 1$ KHz, $25^\circ C$ , 1 $\mu sec$ Square wave
Max peak forward voltage	$V_{FM}$ .57 Volts	$I_{FM} = 30A: T_J = 175^\circ C^*$
Max peak forward voltage	$V_{FM}$ .70 Volts	$I_{FM} = 30A: T_J = 25^\circ C^*$
Max peak reverse current	$I_{RM}$ 25 mA	$V_{RRM}, T_J = 125^\circ C^*$
Max peak reverse current	$I_{RM}$ 1.5 mA	$V_{RRM}, T_J = 25^\circ C$
Typical junction capacitance per leg	$C_J$ 1800 pF	$V_R = 5.0V, T_J = 25^\circ C$

\*Pulse test: Pulse width 300  $\mu sec$ , Duty cycle 2%

### Thermal and Mechanical Characteristics

Storage temp range	$T_{STG}$	$-65^\circ C$ to $175^\circ C$
Operating junction temp range	$T_J$	$-65^\circ C$ to $175^\circ C$
Maximum thermal resistance (standard polarity)	$R_{\theta JC}$	$1.4^\circ C/W$ Junction to case
Maximum thermal resistance (reverse polarity)	$R_{\theta JC}$	$2.2^\circ C/W$ Junction to case
Typical thermal resistance	$R_{\theta CS}$	$0.5^\circ C/W$ Case to sink
Weight		1.0 ounces (28 grams) typical

# SBT3040 — SBT3050

Figure 1  
Typical Forward Characteristics

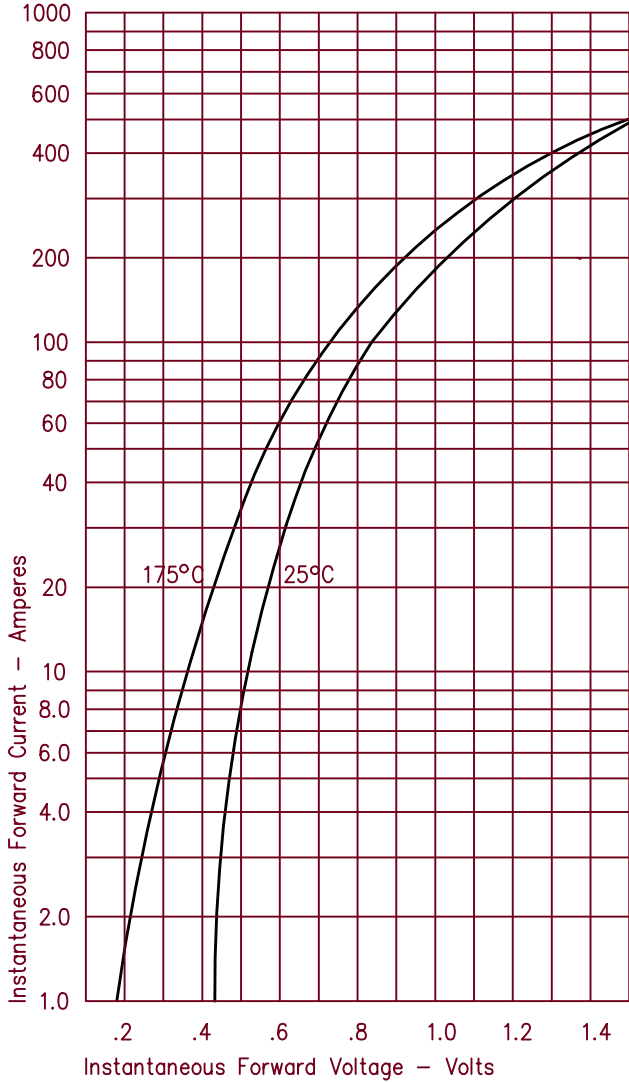

Figure 3  
Typical Junction Capacitance

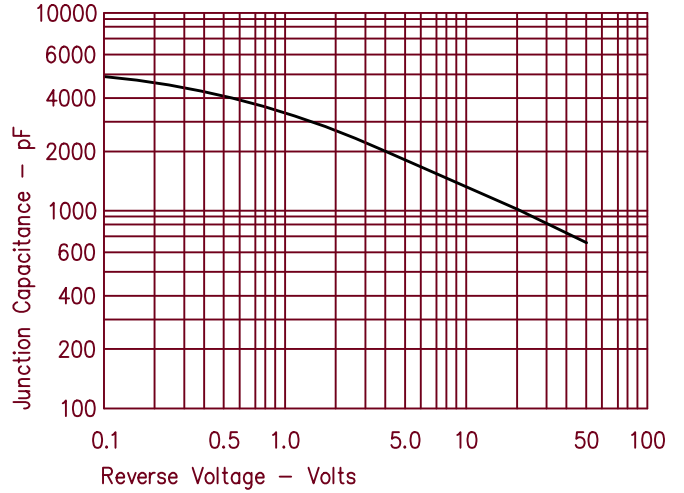

Figure 4  
Forward Current Derating - Standard Polarity

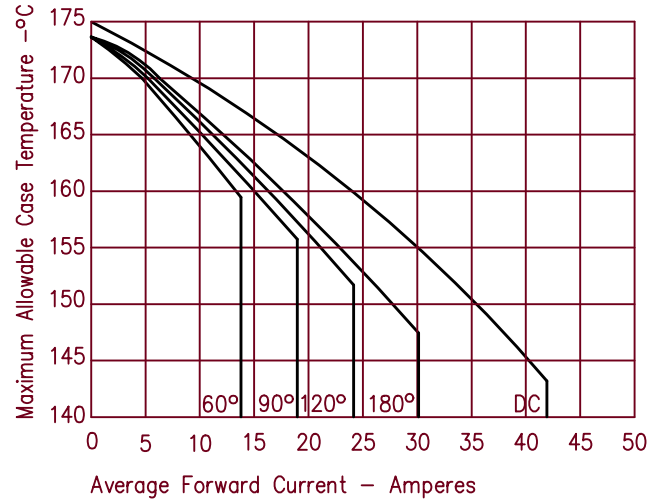

Figure 2  
Typical Reverse Characteristics

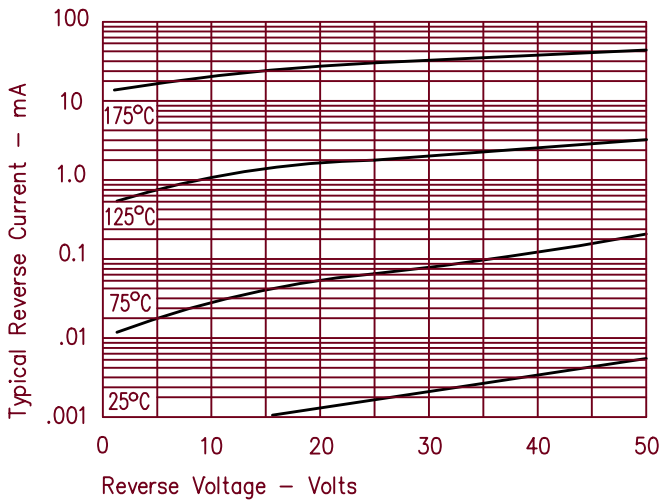
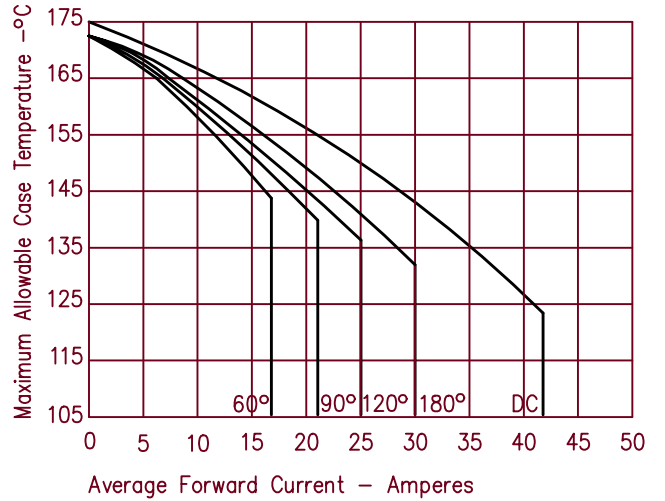

Figure 5  
Forward Current Derating - Reverse Polarity



# SBT3040 – SBT3050

Figure 6  
Maximum Forward Power Dissipation – Standard Polarity

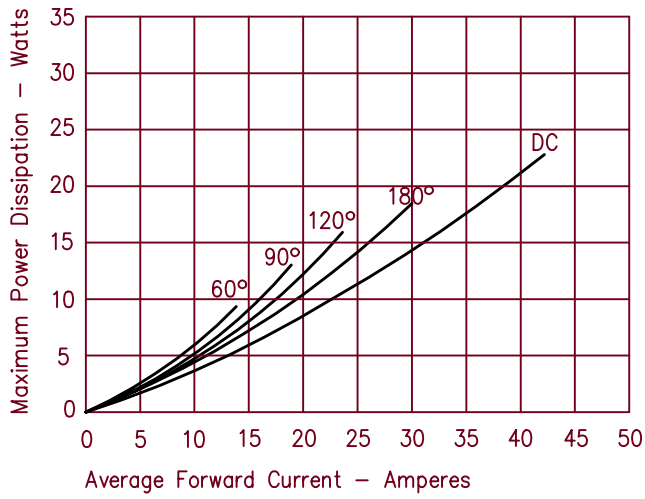

Figure 7  
Maximum Forward Power Dissipation – Reverse Polarity

