

# Schottky Rectifier SBT3060

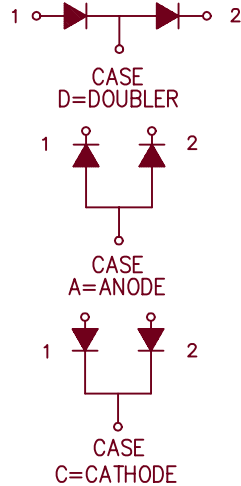
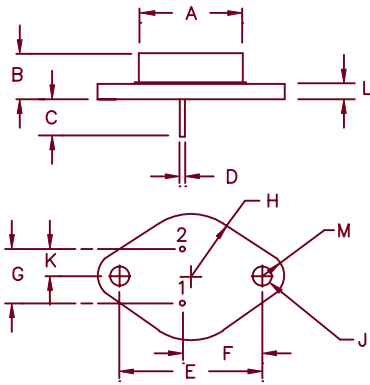

Dim.	Inches		Millimeter		Notes
	Minimum	Maximum	Minimum	Maximum	
A	—	.875	—	22.23	Dia.
B	.250	.450	6.35	11.43	
C	.435	—	11.05	—	
D	.038	.043	.97	1.09	Dia.
E	1.177	1.197	29.90	30.40	
F	.655	.675	16.64	17.15	
G	.420	.440	10.67	11.18	
H	—	.525	—	13.34	Rad.
J	.151	.161	3.84	4.09	Dia.
K	.205	.225	5.21	5.72	
L	—	.135	—	3.43	
M	—	.188	—	4.78	Rad.

## TO-204AA (TO-3)

Microsemi Catalog Number	Working Peak Reverse Voltage	Repetitive Peak Reverse Voltage
SBT3060*	60V	60V

\*ADD D, C, or A

- Schottky Barrier Rectifier
- Guard Ring Protection
- VRRM 60V
- 30 Amperes/package
- Reverse Energy Tested

### Electrical Characteristics Per Leg

Average forward current (standard)	I <sub>F(AV)</sub> 15 Amps	T <sub>C</sub> = 159°C, Square wave, R <sub>θJC</sub> = 1.4°C/W
Average forward current (reverse)	I <sub>F(AV)</sub> 15 Amps	T <sub>C</sub> = 150°C, Square wave, R <sub>θJC</sub> = 2.2°C/W
Maximum surge current	I <sub>FSM</sub> 600 Amps	8.3 ms, half sine T <sub>J</sub> = 175°C
Max repetitive peak reverse current	I <sub>R(OV)</sub> 2 Amps	f = 1 KHz, 25°C, 1 μsec Square wave
Typical forward voltage	V <sub>FM</sub> 0.60 Volts	I <sub>FM</sub> = 30A: T <sub>J</sub> = 175°C*
Max peak forward voltage	V <sub>FM</sub> 0.74 Volts	I <sub>FM</sub> = 30A: T <sub>J</sub> = 25°C*
Max peak reverse current	I <sub>RM</sub> 25 mA	V <sub>R</sub> = 5.0V, T <sub>J</sub> = 25°C
Max peak reverse current	I <sub>RM</sub> 1.5 mA	V <sub>RRM</sub> , T <sub>J</sub> = 125°C*
Typical junction capacitance per leg	C <sub>J</sub> 1200 pF	V <sub>RRM</sub> , T <sub>J</sub> = 25°C

\*Pulse test: Pulse width 300 μsec, Duty cycle 2%

### Thermal and Mechanical Characteristics

Storage temp range	T <sub>STG</sub>	-65°C to 175°C
Operating junction temp range	T <sub>J</sub>	-65°C to 175°C
Maximum thermal resistance (standard polarity)	R <sub>θJC</sub>	1.4°C/W Junction to case
Maximum thermal resistance (reverse polarity)	R <sub>θJC</sub>	2.2°C/W Case to sink
Typical thermal resistance (greased)	R <sub>θCS</sub>	0.5°C/W Junction to case
Weight		1.0 ounces (28 grams) typical

# SBT3060

Figure 1  
Typical Forward Characteristics—Per Leg

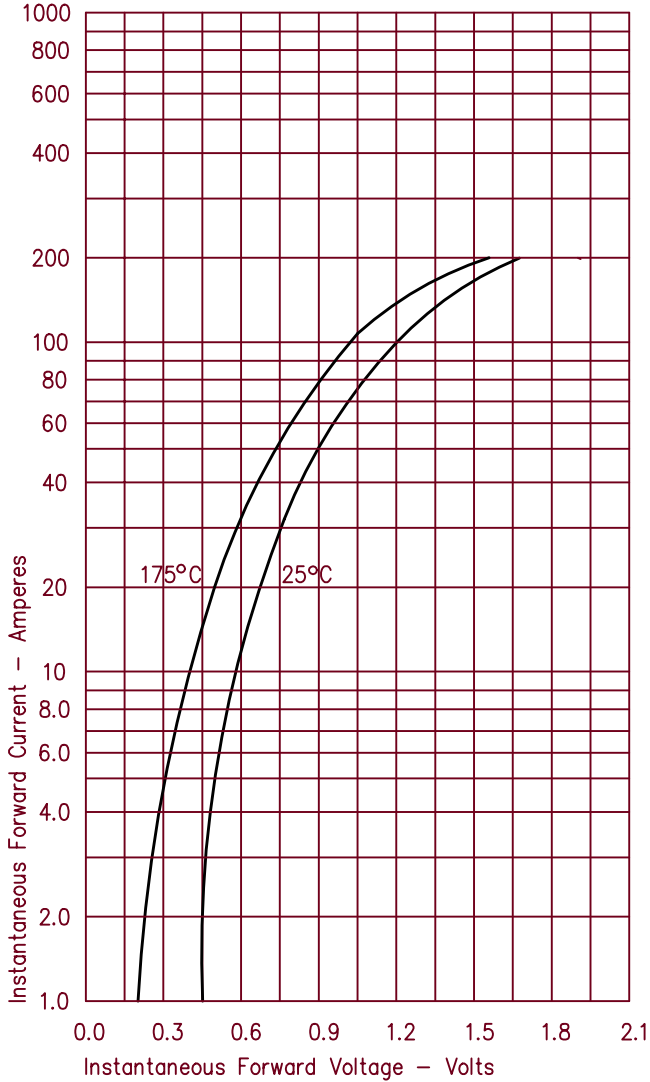

Figure 3  
Typical Junction Capacitance—Per Leg

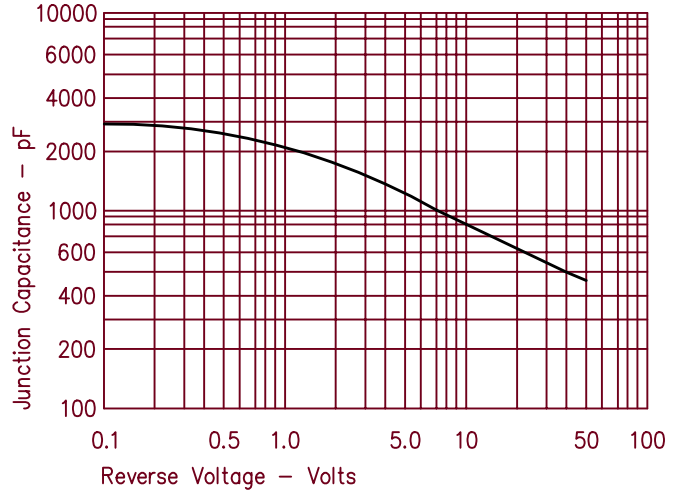

Figure 4  
Forward Current Derating—Per Leg (Standard Polarity)

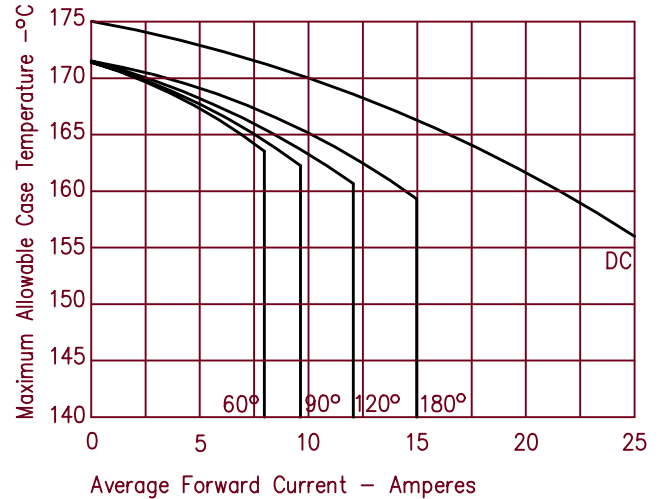

Figure 2  
Typical Reverse Characteristics—Per Leg

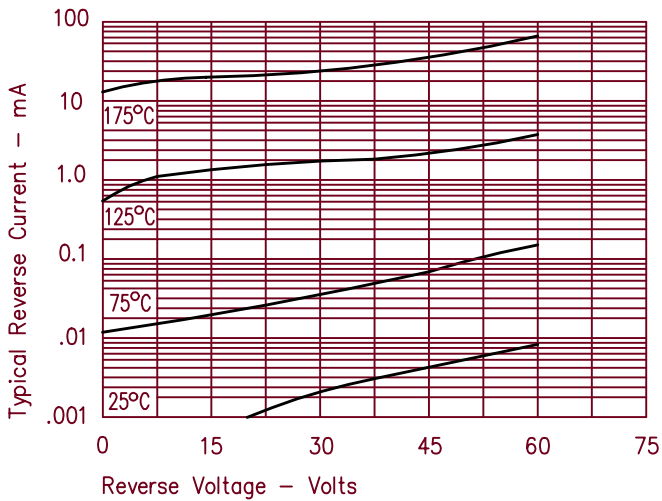
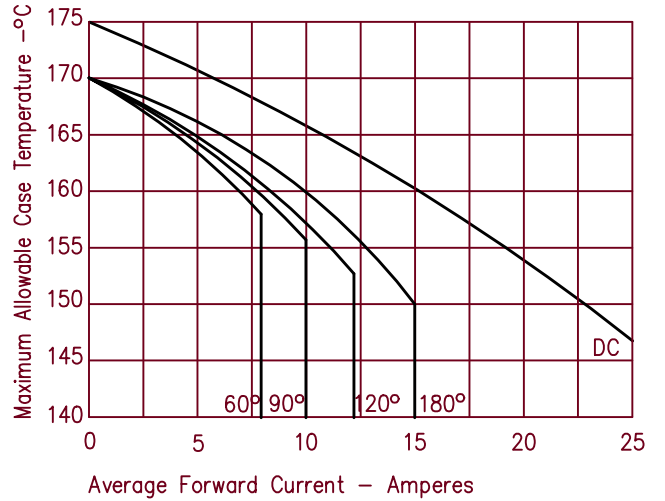

Figure 5  
Forward Current Derating—Per Leg (Reverse Polarity)



# SBT3060

Figure 6  
Maximum Forward Power Dissipation—Per Leg

