

RF & MICROWAVE TRANSISTORS
108–152MHz APPLICATIONS

- FM CLASS C TRANSISTOR
- FREQUENCY 150MHz
- VOLTAGE 28V
- POWER OUT 30W
- POWER GAIN 10dB
- GOLD METALLIZATION
- COMMON EMITTER

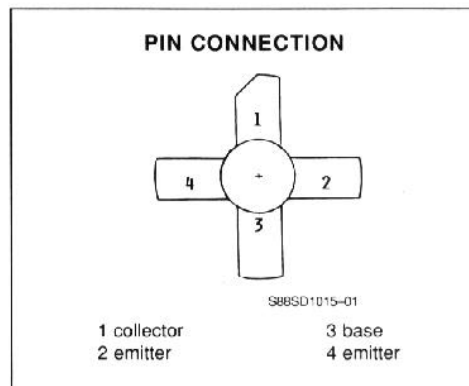
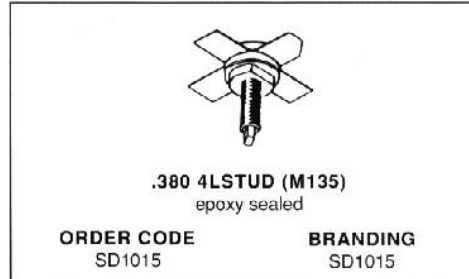

DESCRIPTION

The SD1015 is a 28V gold metallized epitaxial silicon NPN planar transistor designed for 108-152MHz FM applications.

This device utilizes diffused emitter resistors to achieve infinite VSWR at rated operating conditions.

ABSOLUTE MAXIMUM RATINGS ($T_{case} = 25^{\circ}C$)

Symbol	Parameter	Value	Unit
V_{CBO}	Collector - Base Voltage	36.0	V
V_{CEO}	Collector - Emitter Voltage	18.0	V
V_{CES}	Collector - Emitter Voltage	36.0	V
V_{EBO}	Emitter - Base Voltage	4.0	V
I_C	Collector Current	1.0	A
P_{tot}	Total Power Dissipation	10.0	W
T_{stg}	Storage Temperature	- 65 to + 150	$^{\circ}C$
T_j	Junction Temperature	+ 200	$^{\circ}C$

THERMAL DATA

$R_{th(j-c)}$	Junction-case Thermal Resistance	4.4	$^{\circ}C/W$
---------------	----------------------------------	-----	---------------

SD1015

ELECTRICAL CHARACTERISTICS ($T_{case} = 25^{\circ}C$)

STATIC

Symbol	Test Conditions	Value			Unit
		Min.	Typ.	Max.	
BV_{CES}	$I_C = 200mA$ $V_{BE} = 0$	65.0			V
BV_{CEO}	$I_E = 200mA$ $I_B = 0$	35.0			V
BV_{EBO}	$I_E = 10.0mA$ $I_C = 0$	4.0			V
I_{CBO}	$V_{CB} = 30.0V$ $I_E = 0$			2.0	mA
h_{FE}	$V_{CE} = 5.0V$ $I_C = 200mA$	35.0			

DYNAMIC

Symbol	Test Conditions	Value			Unit
		Min.	Typ.	Max.	
P_O	$f = 150MHz$ $V_{CC} = 13.5V$	12.5			W
G_P	$f = 150MHz$ $V_{CC} = 13.5V$	7.0			dB
P_O	$f = 150MHz$ $V_{CC} = 28V$	30			W
G_P	$f = 150MHz$ $V_{CC} = 28V$	10			dB
C_{OB}	$f = 1MHz$ $V_{CB} = 30.0V$ $I_E = 0$			250	pF
C_{ib}	$f = 1MHz$ $V_{EB} = 0.5V$ $I_C = 0$		300		pF

APPLICATION INFORMATION (typical curves)

POWER OUT VS POWER IN

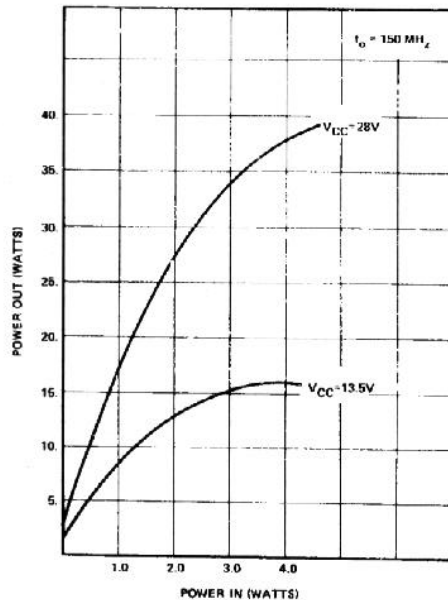

S88SD1015-02

POWER OUT VS FREQUENCY (13.5V)

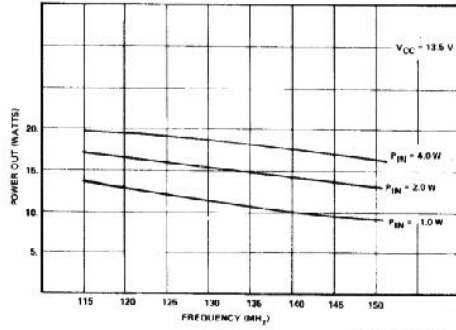

S88SD1015-03

POWER OUT VS FREQUENCY (28V)

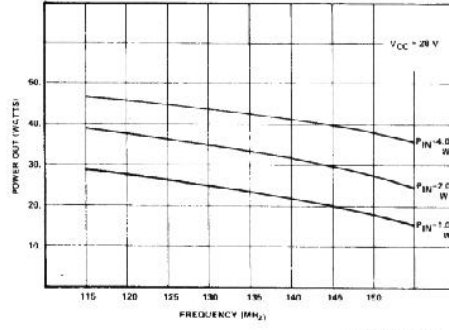

S88SD1015-04

SERIES SOURCE IMPEDANCE VS FREQUENCY (13.5V, 28V)

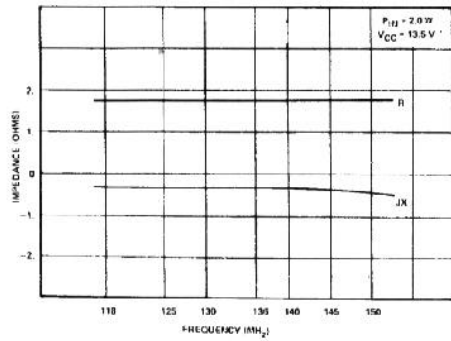

S88SD1015-05

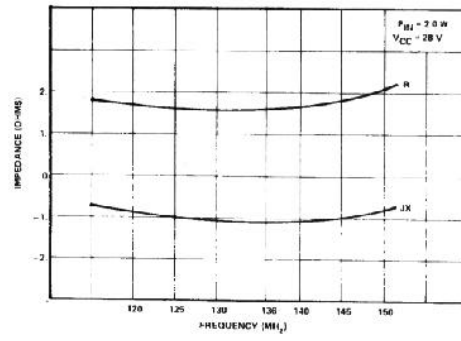

S88SD1015-06

SERIES COLLECTOR LOAD IMPEDANCE VS FREQUENCY (13.5V, 28V)

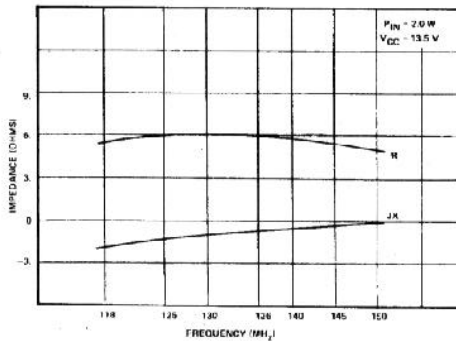

S88SD1015-07

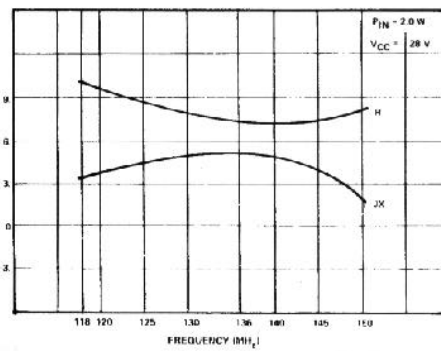

S88SD1015-08

TEST FIXTURE

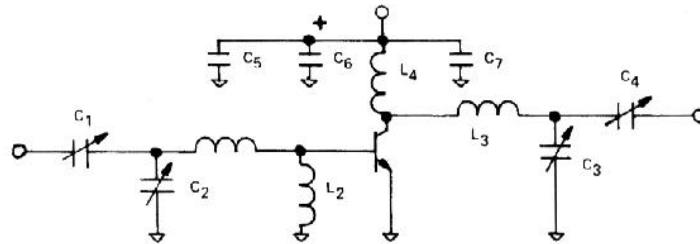
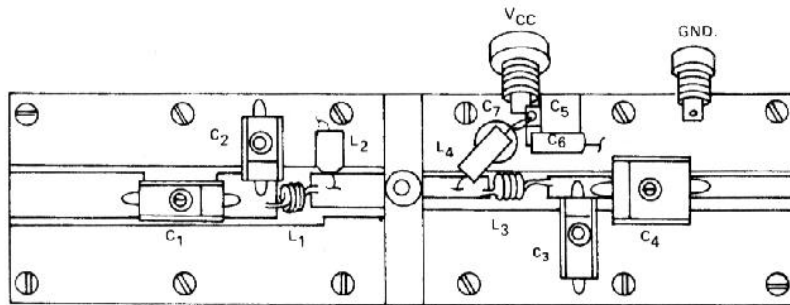

588SD1015-09

COMPONENT LIST

- C₁, C₂ ARCO 422
- C₃ ARCO 422
- C₄ ARCO 463
- C₅ 1000pF UNELCO
- C₆ 10 μ F ELECTROLYTIC 35V

- C₇ .01pf CEREMIC DISC.
- L₁ 3T #22, 1/8 ID
- L₂ RFC FERROXCUBE
- L₃ 2T #18, 1/4 ID
- L₄ .47 μ H MOLDED CHOKE

PACKAGE MECHANICAL DATA

.380 4LSTUD

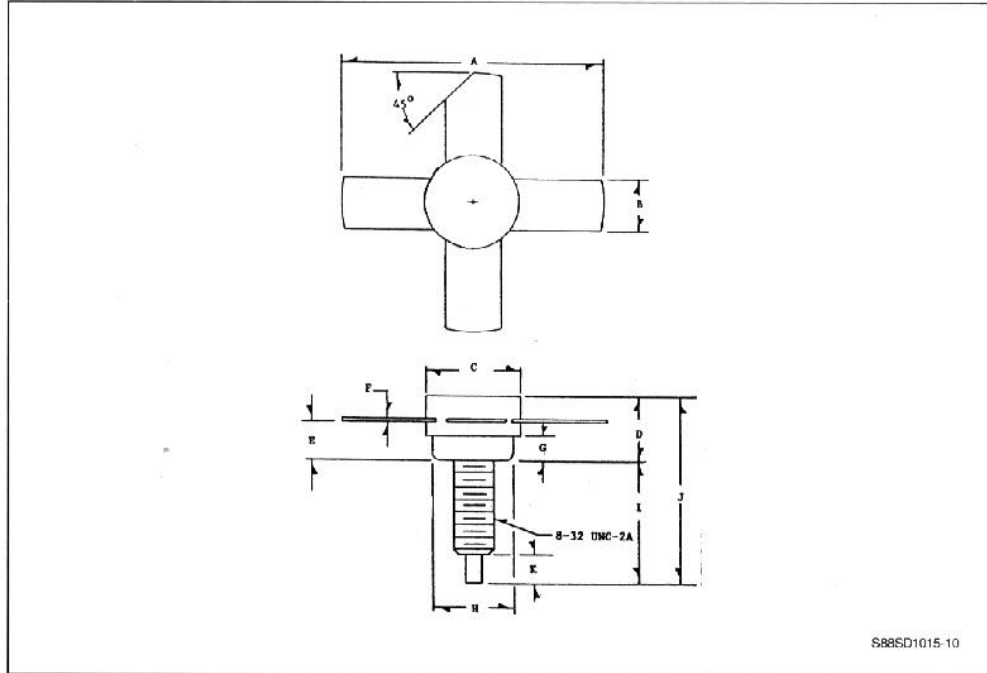

	Minimum Inches	Maximum Inches
A	.980	
B	.220	.230
C	.370	.385
D		.275
E	.155	.175
F	.004	.007

	Minimum Inches	Maximum Inches
G	.090	.100
H	.320	.330
I	.450	.490
J		.750
K	.100	.130