

Ultra Fast Recovery Rectifiers

UFR70, 71 & 72

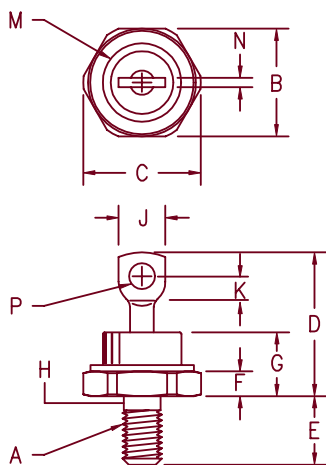

Notes:

- 1/4-28
- Full threads within 2 1/2 threads
- For Reverse Polarity add R to Part Number
Standard Polarity: Stud is Cathode
Reverse Polarity: Stud is Anode

Dim.	Inches		Millimeter		Notes
	Minimum	Maximum	Minimum	Maximum	
A	---	---	---	---	1
B	.669	.688	16.99	17.48	
C	---	.793	---	20.14	
D	.750	1.00	19.05	25.40	
E	.422	.453	10.72	11.51	
F	.115	.200	2.92	5.08	
G	---	.450	---	11.43	
H	.220	.249	5.59	6.32	2
J	---	.375	---	9.53	
K	.156	---	3.97	---	
M	---	.667	---	16.94	Dia
N	---	.080	---	2.03	
P	.140	.175	3.56	4.45	Dia

D0203AB (D05)

- Ultra Fast Recovery Rectifier
- 175°C Junction Temperature
- V_{RRM} 100 to 800V
- High Reliability
- 70 Amps current rating
- t_{RR} 50 to 75 nsec maximum

Microsemi Catalog Number	Working Peak Reverse Voltage	Peak Reverse Voltage
UFR7010*	100V	100V
UFR7015*	150V	150V
UFR7020*	200V	200V
UFR7120*	300V	300V
UFR7130*	400V	400V
UFR7140*	500V	500V
UFR7250*	600V	600V
UFR7260*	700V	700V
UFR7270*	800V	800V
UFR7280*		

*Add Suffix R For Reverse Polarity

Electrical Characteristics

	UFR70	UFR71	UFR72	
Average forward current	$I_F(AV)$ 70A	70A	70A	Square wave, $R_{\theta JC} = 0.8^\circ C/W$
Case Temperature	T_C 125°C	110°C	105°C	
Maximum surge current	I_{FSM} 1000A	800A	700A	8.3 ms, half sine, $T_J = 175^\circ C$
Max peak forward voltage	V_{FM} .975V	1.25V	1.35V	$I_{FM} = 70A: T_J = 25^\circ C^*$
Max reverse recovery time	t_{RR} 50 ns	60ns	75 ns	1/2A, 1A, 1/4A, $T_J = 25^\circ C$
Max peak reverse current	I_{RM} ---	3.0 mA	---	$V_{RRM}, T_J = 125^\circ C$
Max peak reverse current	I_{RM} ---	25 μA	---	$V_{RRM}, T_J = 25^\circ C$
Typical Junction Capacitance	C_J 300 pF	150 pF	150 pF	$V_R = 10V, f = 1Mhz, T_J = 25^\circ C$

*Pulse test: Pulse width 300 μsec , Duty cycle 2%

Thermal and Mechanical Characteristics

Storage temp range	T_{STG}	-65°C to 175°C
Operating junction temp range	T_J	-65°C to 175°C
Max thermal resistance	$R_{\theta JC}$	0.8°C/W Junction to case
Typical thermal resistance	$R_{\theta CS}$	0.2°C/W Case to sink
Mounting torque		25-30 inch pounds
Weight		.54 ounces (15.3 grams) typical

UFR70

Figure 1
Typical Forward Characteristics

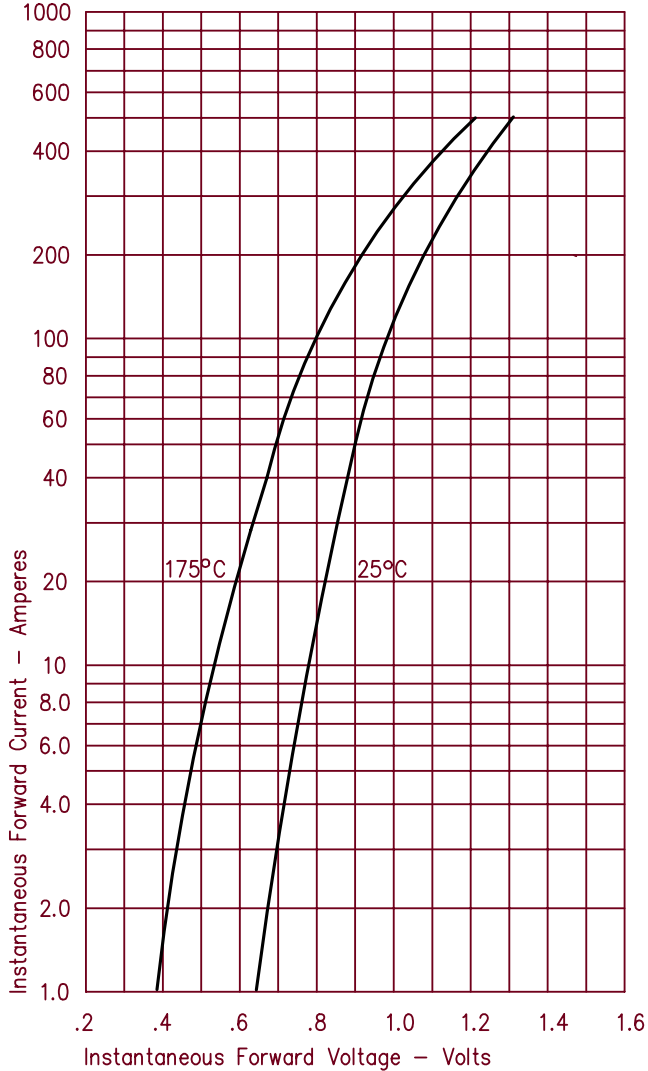

Figure 3
Typical Junction Capacitance

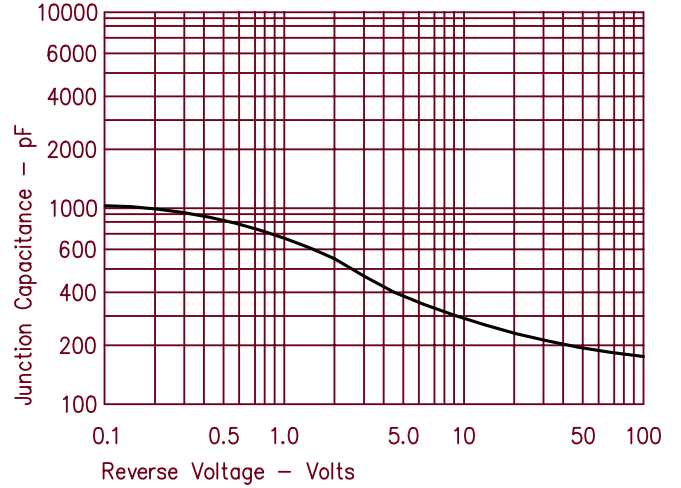

Figure 4
Forward Current Derating

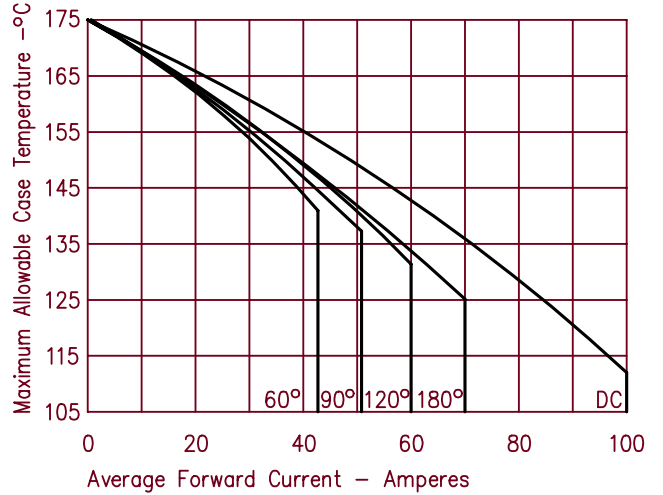

Figure 2
Typical Reverse Characteristics

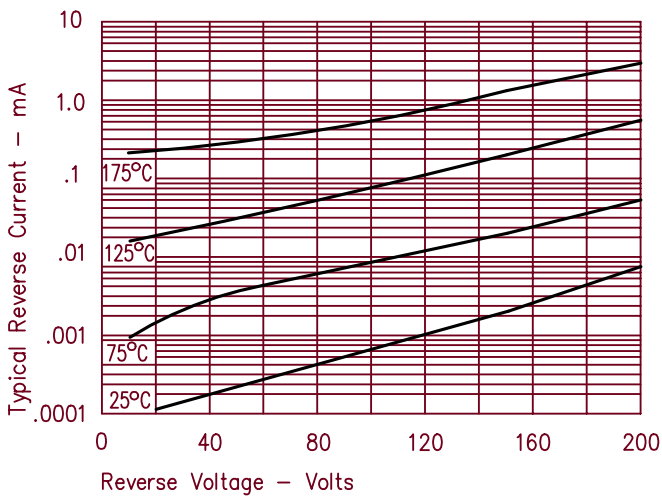
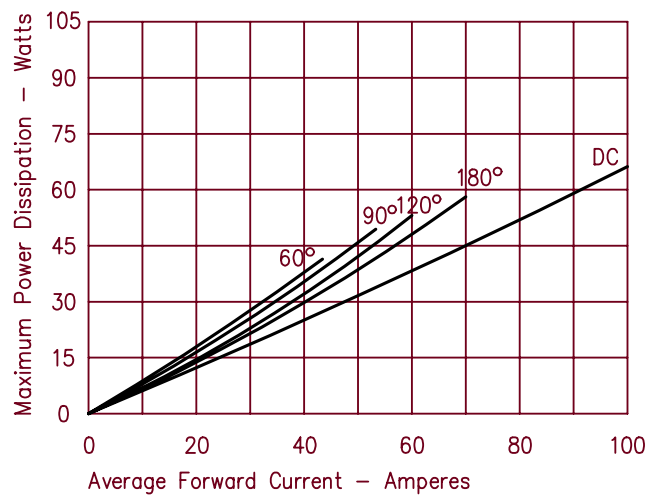

Figure 5
Maximum Forward Power Dissipation



UFR71

Figure 1
Typical Forward Characteristics

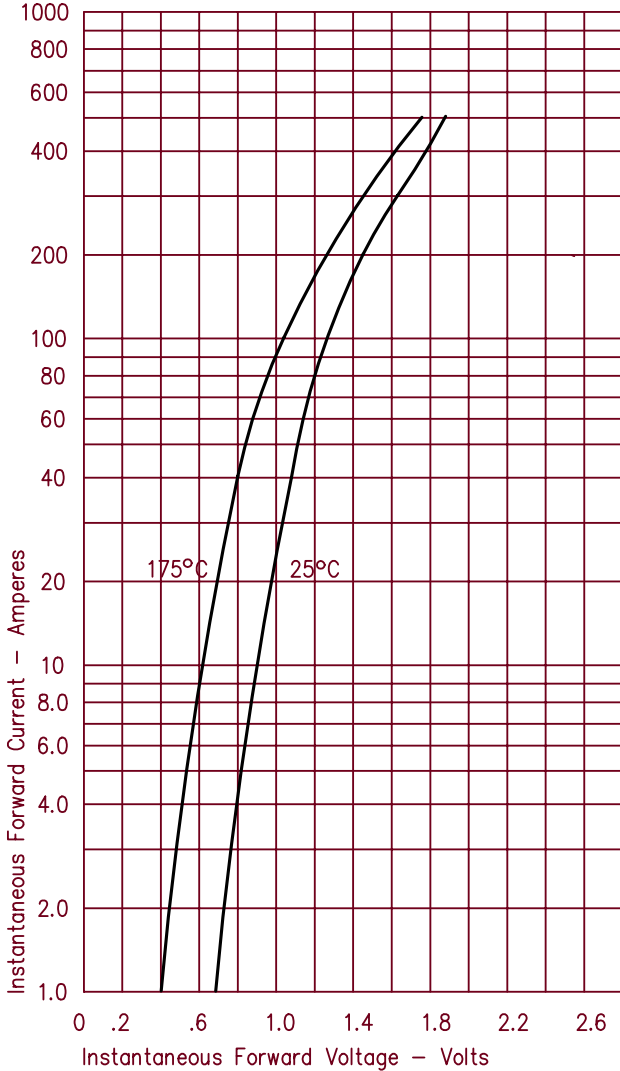

Figure 3
Typical Junction Capacitance

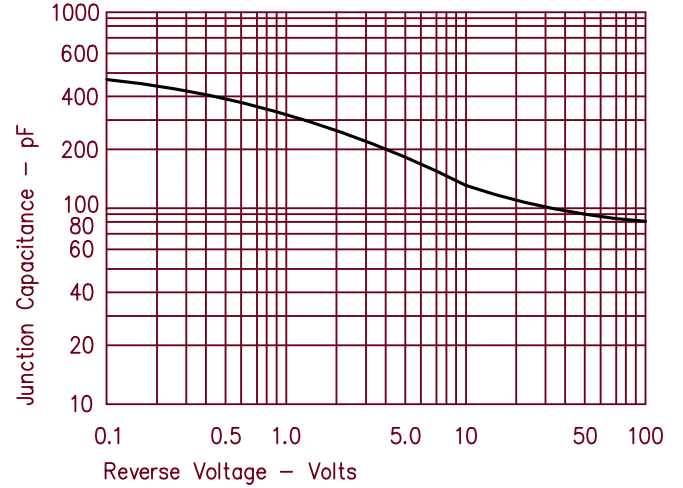

Figure 4
Forward Current Derating

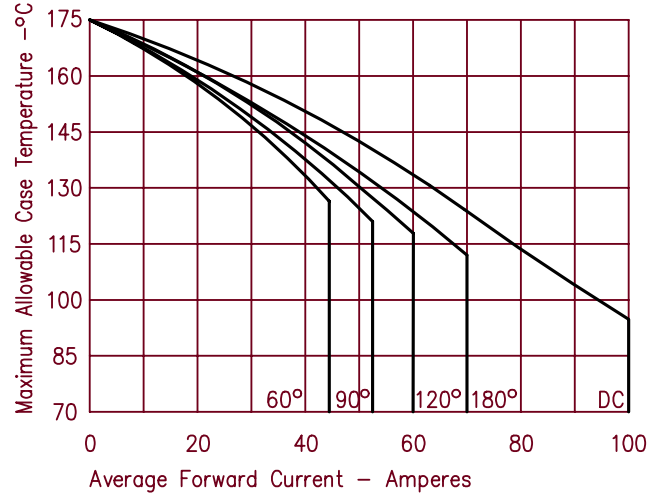

Figure 2
Typical Reverse Characteristics

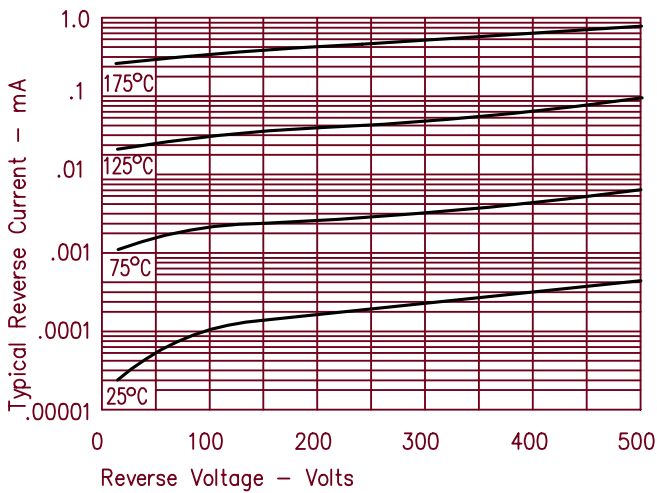
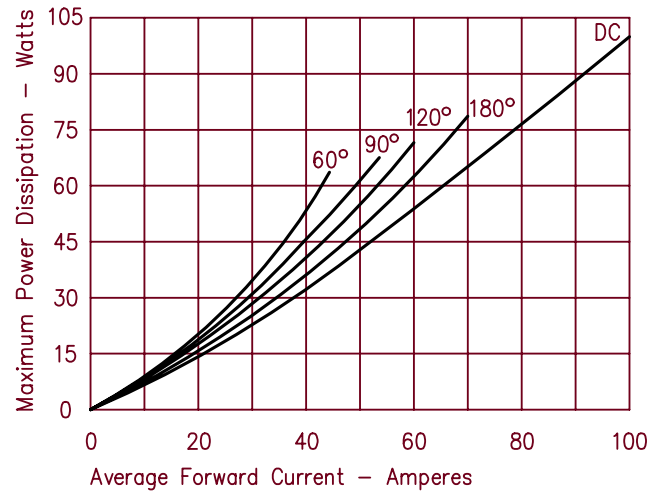

Figure 5
Maximum Forward Power Dissipation



UFR72

Figure 1
Typical Forward Characteristics

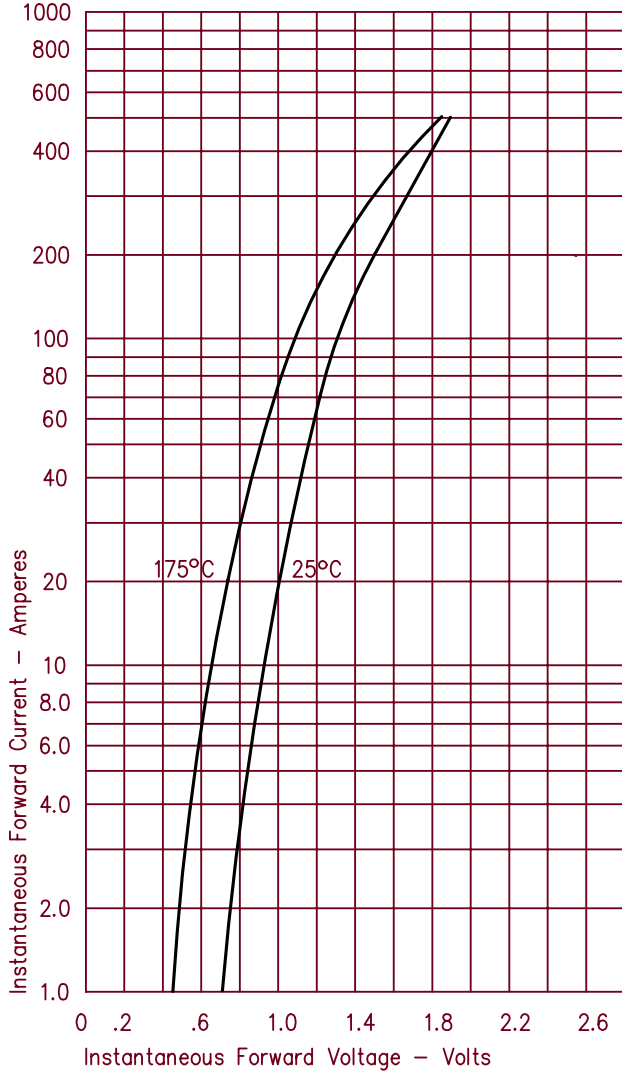

Figure 3
Typical Junction Capacitance

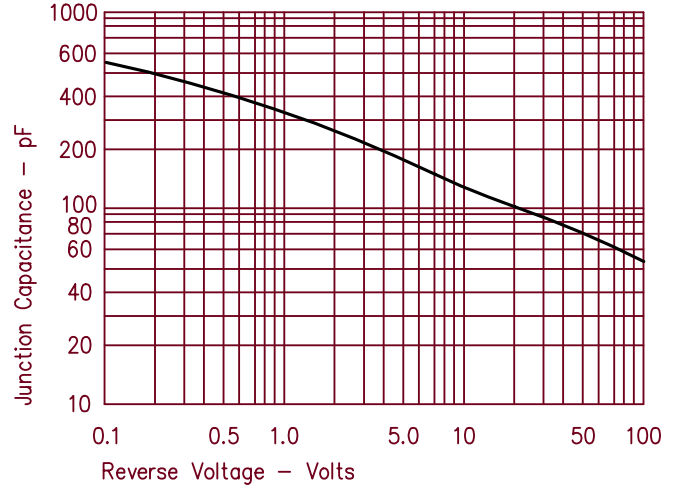

Figure 4
Forward Current Derating

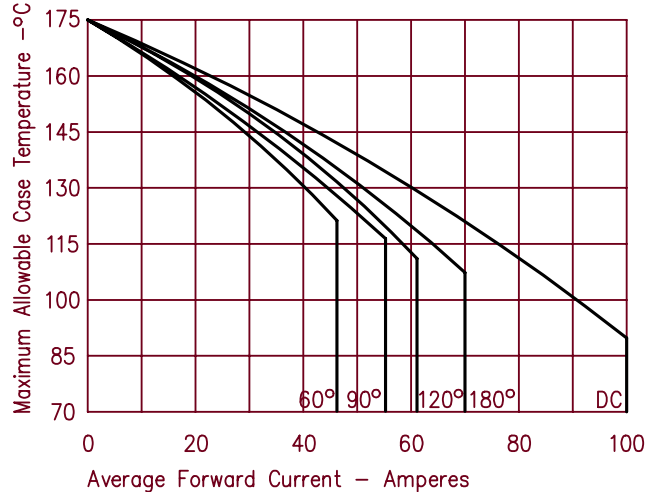

Figure 2
Typical Reverse Characteristics

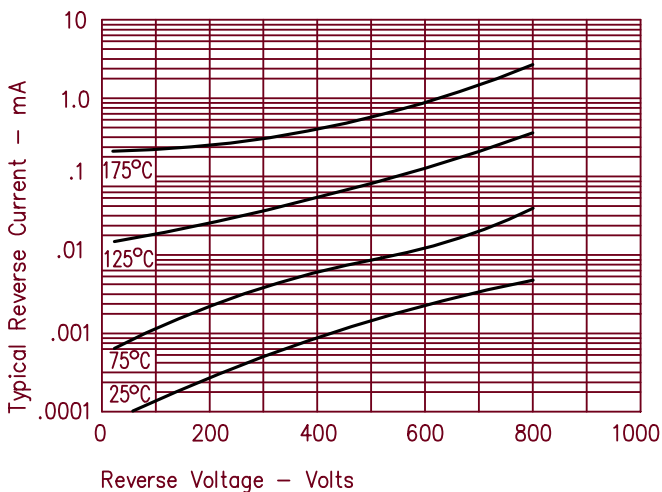

Figure 5
Maximum Forward Power Dissipation

