

**UM2300
 SERIES**

**PIN DIODE
 SWITCH**

Features

- LF band (100 KHz) PIN
- Long Lifetime (80 μ s typ.)
- High Power (1 KW CW)
- Low Loss (0.2 dB)
- Voltage Ratings to 1000 V
- High Isolation (35 dB)
- Very Low Distortion (IP3 = > 60 dBm)

Description

UM2300 Series PIN diodes are designed for transmit / receive switch and attenuator application in LF band (100 KHz) and above. As series configured switches, these long lifetime (80 μ s typ) diodes can control up to 2.5 KW CW in a 50 ohm system. In MF band, insertion loss is less than 0.2 dB and isolation is greater than 35 dB ('off' state).

The UM2300 series offers the lowest distortion performance in both transmit & receive modes. Less than 10 mA forward bias is required to obtain an IP3 of 60 dBm at 150 KHz with 1 watt per tone. The forward biased resistance/reactance vs. frequency characteristics are flat down to 10 KHz. Capacitance vs. reverse bias voltage characteristic is flat down to 1 MHz.

In attenuator configurations, the UM2300 produces extremely low distortion at low values of attenuator control current, & very low insertion loss (0.2 dB) in the ' 0 dB ' attenuator state.

Electrical Specifications (25°C)

Test	Min.	Typ.	Max.	Units	Conditions
Diode Resistance R_S		0.3	0.4	W	$F_1 = 1 \text{ MHz}, 100 \text{ mA}$
Capacitance C_T		15	20	pF	$F_2 = 1 \text{ MHz}, 100 \text{ V}$
Reverse Current I_R			10	mA	@ Rated Voltage
Carrier Lifetime t	60	80		μ s	$I_f = 10 \text{ mA} / 100 \text{ V}$
IP3	50	60		dBm	2 WATT total, $I_f = 25 \text{ mA}$
					$F_1 = 0.999 \text{ MHz}, F_2 = 1.001 \text{ MHz}$
					1.0 WATT/ tone
Thermal Resistance			1.0	°C / W	25°C Stud Temperature

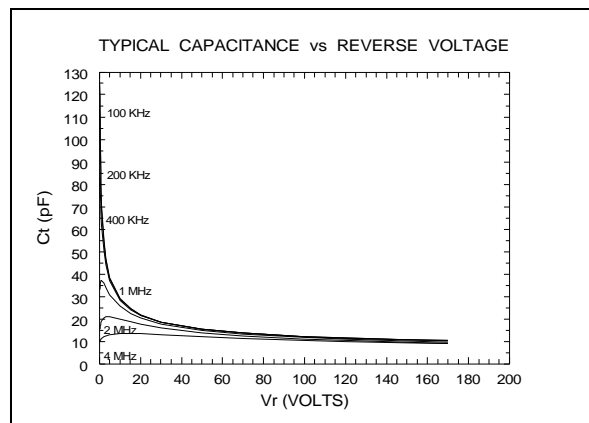

Voltage Ratings (25°C)

Reverse Voltage (V_R) @ $I_R = 10 \text{ mA}$	DEVICE
100 VOLTS.....	UM2301
200 VOLTS.....	UM2302
400 VOLTS.....	UM2304
600 VOLTS.....	UM2306
800 VOLTS.....	UM2308
1000 VOLTS.....	UM2310

**UM2300
 SERIES**

TYPICAL I-V CURVE

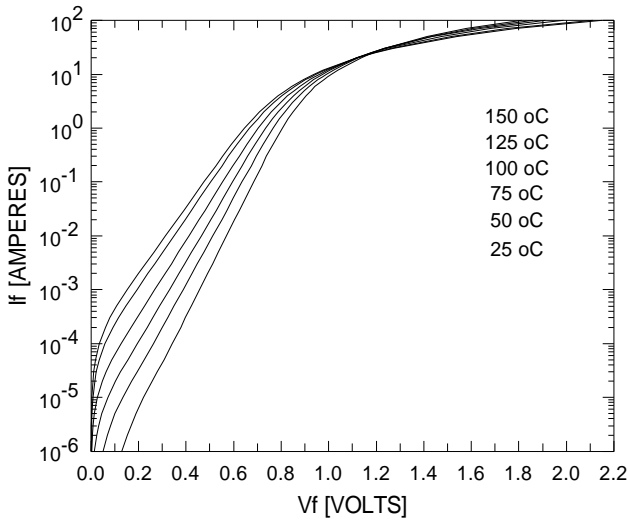

TYPICAL IR vs VR

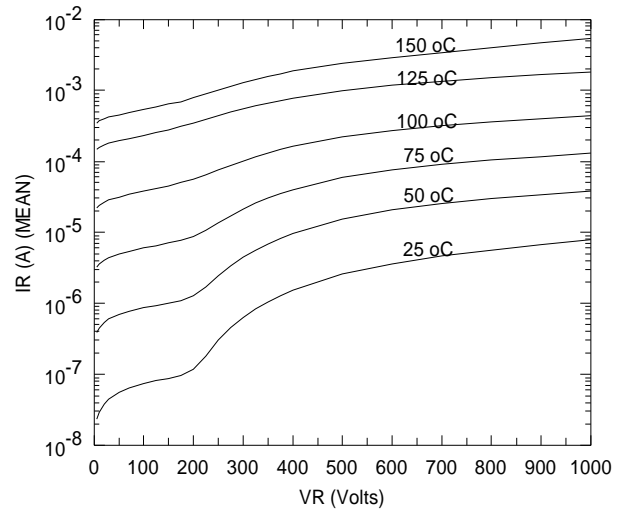

TYPICAL RS vs FORWARD BIAS CURRENT

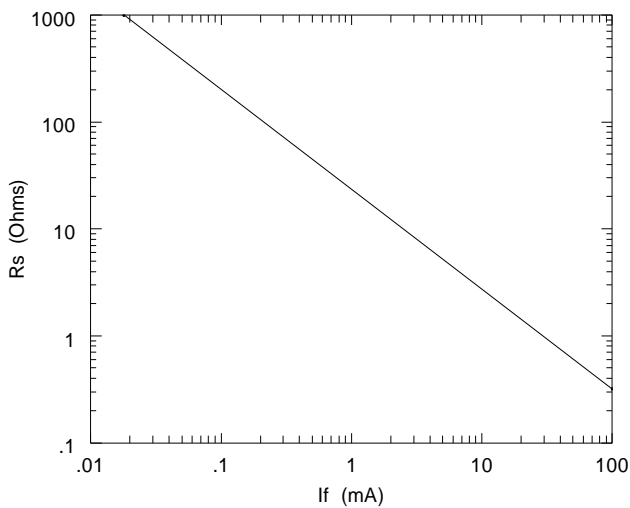

TYPICAL Rp vs REVERSE VOLTAGE

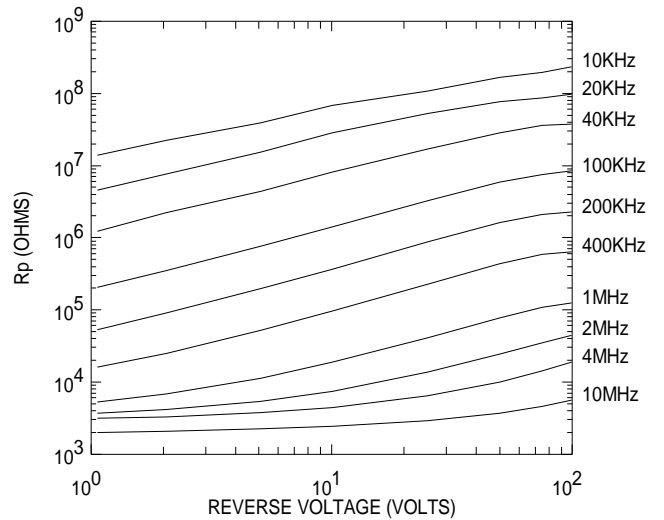

**UM2300
 SERIES**

TYPICAL THERMAL IMPEDANCE

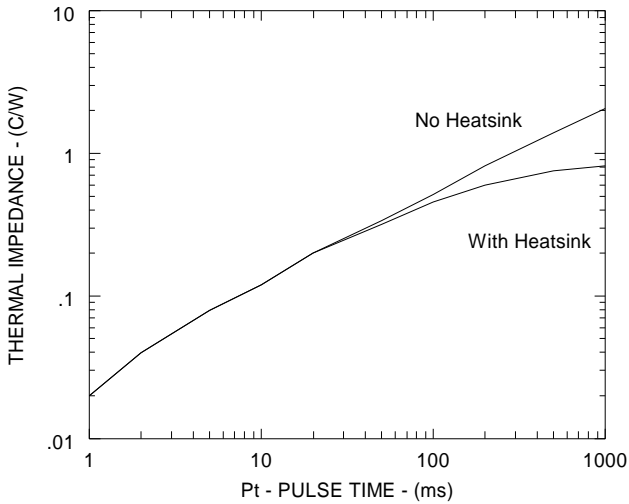

TYPICAL TCVf vs If

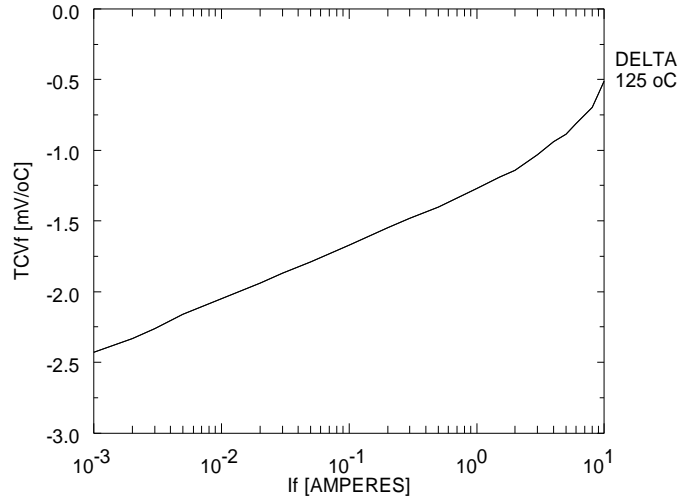

TYPICAL POWER LEVEL vs FORWARD BIAS CURRENT

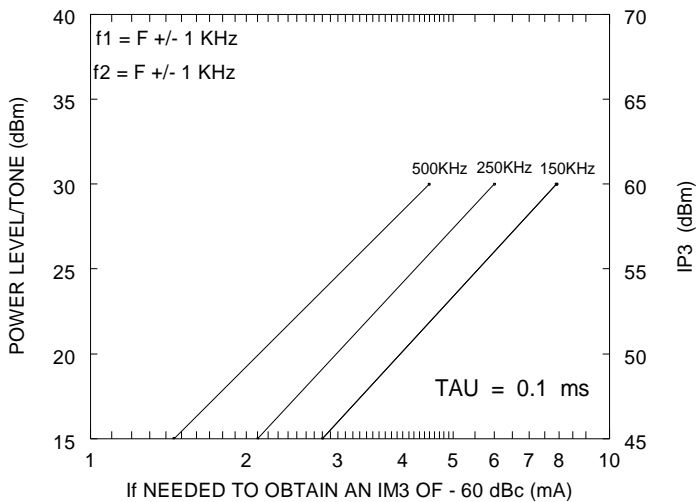

TEST CIRCUIT FOR DISTORTION MEASUREMENTS

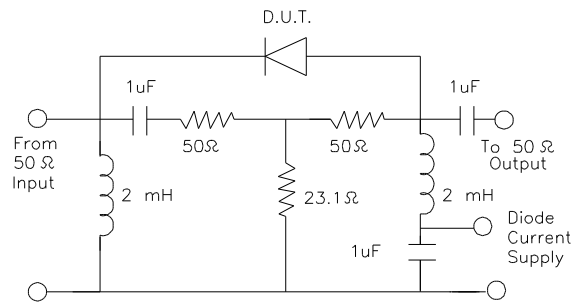

NOTE: Diode Current adjusted for 10 dB Attenuation

**UM2300
SERIES**

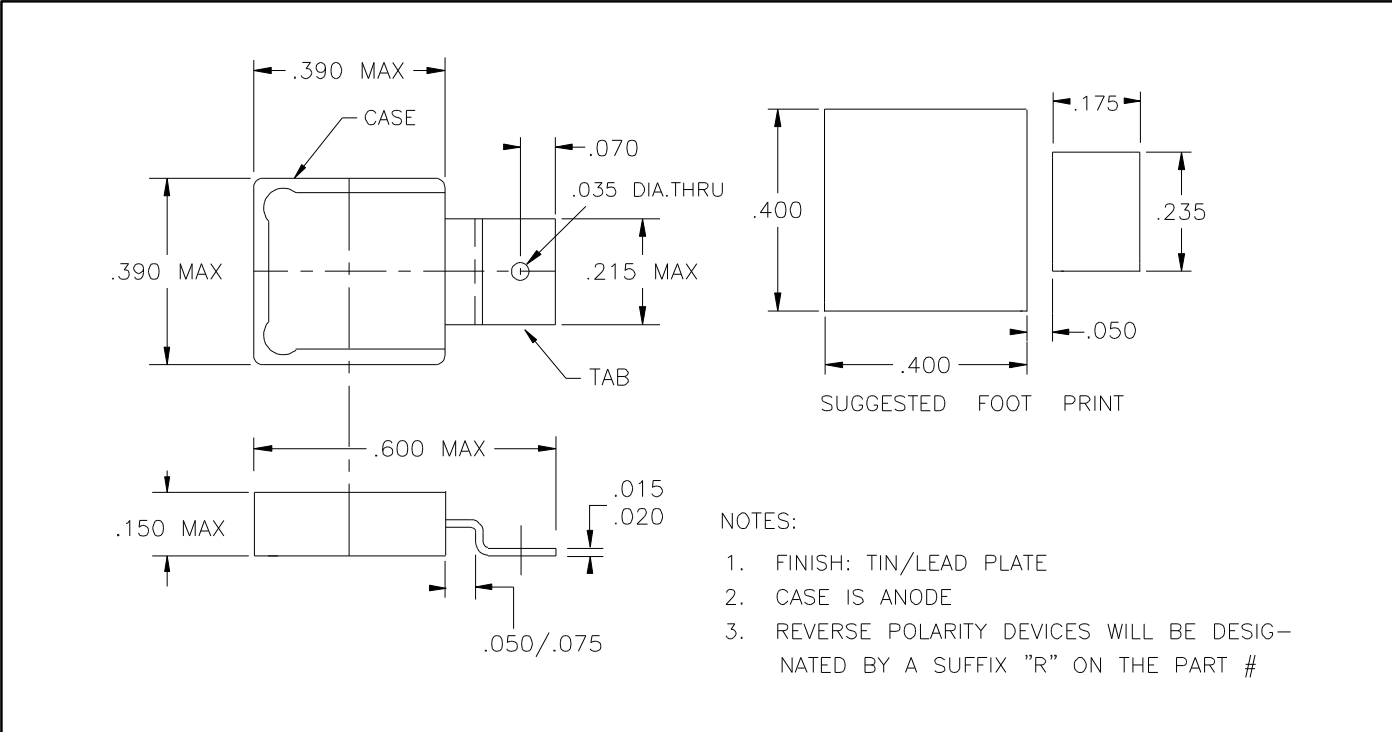

- NOTES:
1. FINISH: TIN/LEAD PLATE
 2. CASE IS ANODE
 3. REVERSE POLARITY DEVICES WILL BE DESIGNATED BY A SUFFIX "R" ON THE PART #

UM2300

