

RECTIFIERS

Standard Recovery, 7.5 Amp to 12 Amp

UT5105-UT5160
 UT6105-UT6160
 UT8105-UT8160
 UT5105HR2-UT5160HR2
 UT6105HR2-UT6160HR2
 UT8105HR2-UT8160HR2

2

FEATURES

- Rating: 12A
- Controlled Avalanche
- Miniature Package
- Surge Rating: 200A

DESCRIPTION

These series of high current rectifiers offers opportunity for size and weight reduction in high power supplies.

ABSOLUTE MAXIMUM RATINGS

Peak Inverse Voltage	12 Amp Series	9 Amp Series	7.5 Amp Series
50V	UT8105/8105HR2	UT6105/6105HR2	UT5105/5105HR2
100V	UT8110/8110HR2	UT6110/6110HR2	UT5110/5110HR2
200V	UT8120/8120HR2	UT6120/6120HR2	UT5120/5120HR2
400V	UT8140/8140HR2	UT6140/6140HR2	UT5140/5140HR2
600V	UT8160/8160HR2	UT6160/6160HR2	UT5160/5160HR2

	12 AMP SERIES	9 AMP SERIES	7.5 AMP SERIES
Maximum Average D.C. Output Current @ T _C = 100°C	12.0A	9.0A	7.5A
Non-Repetitive Sinusoidal Surge Current (8.3ms)	200A	175A	150A
Operating and Storage Temperature Range	-65°C to +175°C		
Thermal Resistance, Junction to Case	7.5°C/Watt		
Current Derating	See current vs. case temperature curve		

MECHANICAL SPECIFICATIONS

UT5105-UT5160 **UT6105-UT6160** **UT8105-UT8160**
UT5105HR2-UT5160HR2 **UT6105HR2-UT6160HR2** **UT8105HR2-UT8160HR2**

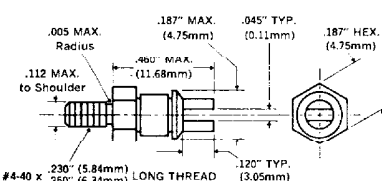

Part Identification: Numerals and polarity letter indicate UTR type number, e.g., UTR 4405.
Polarity: Cathode to Stud is standard. Reverse polarity denoted by "R" suffix.
Finish: Metal parts gold plated per MIL-G-45204, Type II.
Weight: 1.5 grams, typical.
 Also available with insulated stud. Reference Design Note 17.
Installation:
 Maximum unlubricated stud torque: 28 inch-ounces.
 Mounting hardware supplied.
 Do not use a screwdriver in the turret slot for installation purposes, or damage may result.

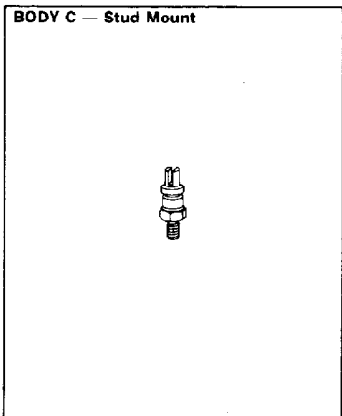

Microsemi Corp.
Watertown
the diode experts

ELECTRICAL SPECIFICATIONS (at 25°C unless noted)

Type	Peak Inverse Voltage	Maximum Forward Voltage	Max. Reverse Current at PIV	
			25°C	100°C
UT8105/8105HR2 UT8110/8110HR2 UT8120/8120HR2 UT8140/8140HR2 UT8160/8160HR2	50V 100V 200V 400V 600V	1V @ 8A	10 μ A	300 μ A
UT6105/6105HR2 UT6110/6110HR2 UT6120/6120HR2 UT6140/6140HR2 UT6160/6160HR2	50V 100V 200V 400V 600V	1V @ 6A	10 μ A	300 μ A
UT5105/5105HR2 UT5110/5110HR2 UT5120/5120HR2 UT5140/5140HR2 UT5160/5160HR2	50V 100V 200V 400V 600V	1V @ 5A	10 μ A	300 μ A

Typical Forward Voltage vs Forward Current.

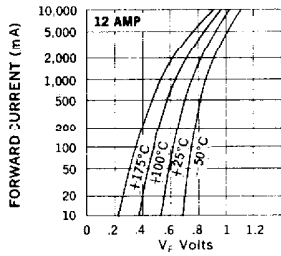

Typical Forward Voltage vs Forward Current

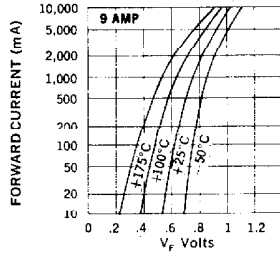

Typical Forward Voltage vs Forward Current

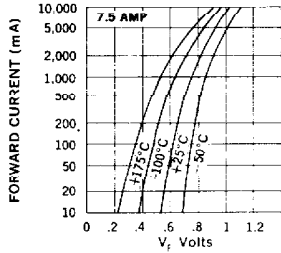

Typical P.I.V. vs Reverse Current

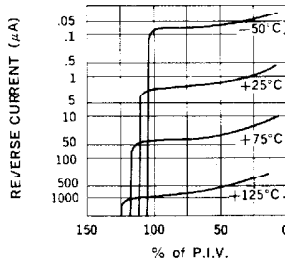

OPTIONAL HIGH RELIABILITY (HR2) SCREENING

The following tests are performed on 100% of the devices specified UT5105HR2 through UT8160HR2.

SCREEN	MIL-STD-750 METHOD	CONDITIONS
1. High Temperature	1032	24 Hours @ 175°C
2. Temperature Cycling	1051	C, 20 Cycles, -65 to +175°C. No dwell required @ 25°C, t ≥ 10 min. @ extremes.
3. Hermetic Seal a. Gross Leak	1071	E, ZYGLO
4. High Temperature Reverse Bias (HTRB)	1038	A, T _A = 150°C, V _R = 80% of rating, 48 hours
5. Interim Electrical Parameters	GO/NO GO	V _F and I _R @ 25°C
6. Power Burn-in	1038	B, T _A = 25°C, 96 Hours, I _O adjusted 150°C, < T _J < 175°C
7. Final Electrical Parameters	GO/NO GO	V _F + I _R @ 25°C PDA = 10% (Final Electricals)

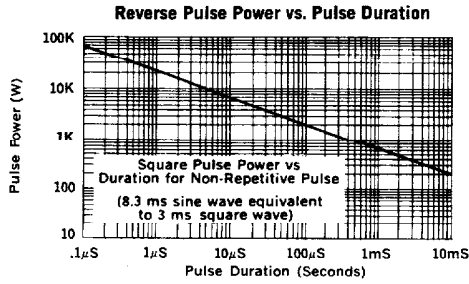
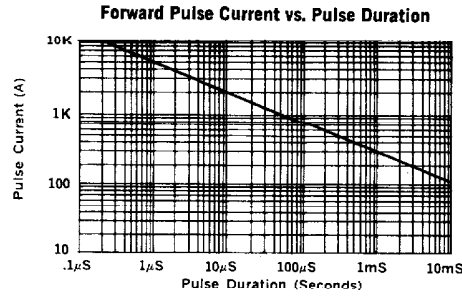
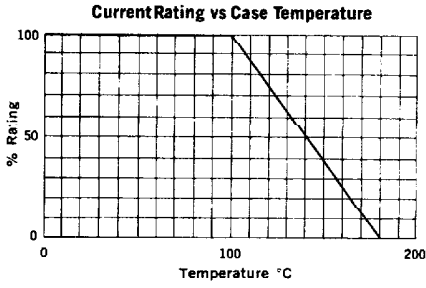

MECHANICAL SPECIFICATIONS

