

DESCRIPTION

The SG3546 is an undervoltage sensing circuit specifically designed for use as a reset controller in 3.3V microprocessor-based applications. Its micropower operation makes this device ideal for portable applications where extended battery life is required. The device offers a 1.2V temperature compensated bandgap reference, a

precision comparator with hysteresis and a high-current open collector output. This device operates from 1 to 10V input supply and drains <math><10\mu\text{A}</math> in the non-fault condition.

The SG3546 is available in an 8-pin 150mil SOIC package or a 3-pin TO-92 package and is rated for an ambient temperature of 0°C to 70°C.

KEY FEATURES

- LOW STANDBY CURRENT
- INTERNAL VOLTAGE THRESHOLD AT 2.95V
- TEMPERATURE COMPENSATED BANDGAP REFERENCE
- PRECISION COMPARATOR WITH 40MV OF HYSTERESIS
- CLAMP DIODE FOR DISCHARGING DELAY CAPACITOR
- OUTPUT CURRENT SINK CAPABILITY (typ 5mA)
- 1-10V INPUT SUPPLY RANGE
- AVAILABLE IN 150MIL, 8-PIN SOIC AND 3-PIN TO-92 PACKAGES

PRODUCT HIGHLIGHT

LOW-VOLTAGE MICROPROCESSOR RESET

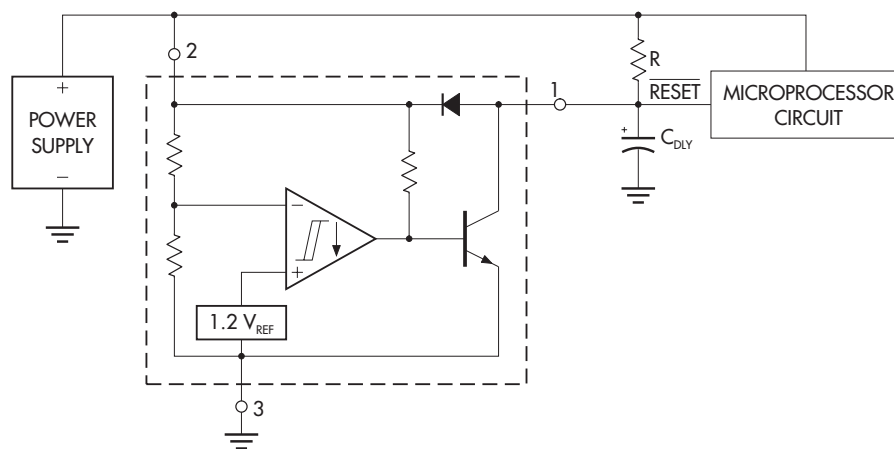

PACKAGE ORDER INFORMATION

T_A (°C)	DM Plastic SOIC 8-pin	LP Plastic TO-92 3-pin
0 to 70	SG3546DM	SG3546LP

Note: All surface-mount packages are available in Tape & Reel. Append the letter "T" to part number. (i.e. SG3546DMT)

FOR FURTHER INFORMATION CALL (714) 898-8121

3.3V UNDERVOLTAGE SENSING CIRCUIT

PRODUCTION DATA SHEET

ABSOLUTE MAXIMUM RATINGS (Note 1)

Input Supply Voltage (V_{IN}).....	-1V to 12V
RESET Output Voltage (V_{OUT})	-1V to 12V
Clamp Diode Forward Current	100mA
Operating Junction Temperature	
Plastic (DM - Package)	150°C
Storage Temperature Range	-65°C to 150°C
Lead Temperature (Soldering, 10 seconds)	300°C

Note 1. Values beyond which damage may occur. All voltages are specified with respect to ground, and all currents are positive into the specified terminal.

THERMAL DATA

DM PACKAGE:

THERMAL RESISTANCE-JUNCTION TO AMBIENT, θ_{JA}	165°C/W
---	---------

LP PACKAGE:

THERMAL RESISTANCE-JUNCTION TO AMBIENT, θ_{JA}	156°C/W
---	---------

Junction Temperature Calculation: $T_J = T_A + (P_D \times \theta_{JA})$.

The θ_{JA} numbers are guidelines for the thermal performance of the device/pc-board system. All of the above assume no ambient airflow.

PACKAGE PIN OUTS

RESET	□	1	□	8	□	N.C.
INPUT	□	2	□	7	□	N.C.
N.C.	□	3	□	6	□	N.C.
GROUND	□	4	□	5	□	N.C.

DM PACKAGE
(Top View)

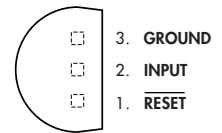

LP PACKAGE
(Top View)

BLOCK DIAGRAM

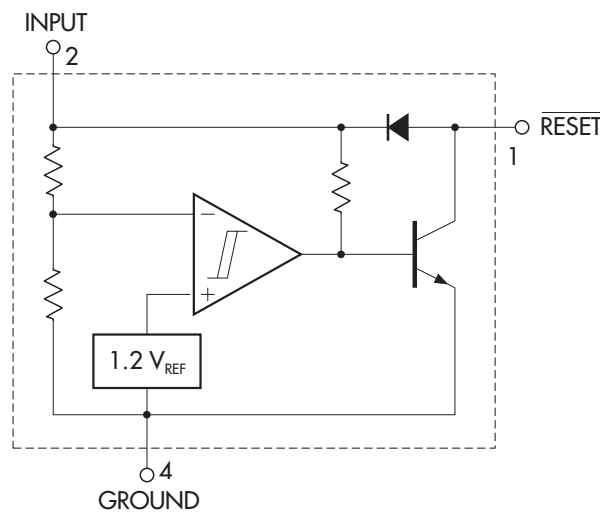

3.3V UNDERVOLTAGE SENSING CIRCUIT

PRODUCTION DATA SHEET

RECOMMENDED OPERATING CONDITIONS (Note 2)

Parameter	Symbol	Recommended Operating Conditions			Units
		Min.	Typ.	Max.	
Input Supply Voltage		1		10	V
RESET Output Voltage				10	V
Clamp Diode Forward Current				50	mA
Operating Ambient Temperature Range:					
SG3546	T_A	0		70	°C

Note 2. Range over which the device is guaranteed functional.

ELECTRICAL CHARACTERISTICS

(Unless otherwise specified, these specifications apply over the operating ambient temperatures of $0^\circ\text{C} \leq T_A \leq 70^\circ\text{C}$ for the SG3546. Low duty cycle pulse testing techniques are used which maintains junction and case temperatures equal to the ambient temperature.)

Parameter	Symbol	Test Conditions	SG3546			Units
			Min.	Typ.	Max.	
Total Device						
Operating Input Voltage Range	V_{IN}		1.0		10	V
Quiescent Input Current	I_{IN}	$V_{IN} = 3.3\text{V}$		10	20	μA
		$V_{IN} = 10\text{V}$		19	50	μA
Comparator Section						
Threshold Voltage						
High-State Output	V_{IH}	V_{IN} Increasing	2.75	2.81	3.0	V
Low-State Output	V_{IL}	V_{IN} Decreasing	2.75	2.86	3.0	V
Hysteresis	V_H			40		mV
RESET Output Section						
Output Sink Saturation	V_{OL}	$V_{IN} = 2.6\text{V}, I_{SINK} = 1\text{mA}$		0.05	0.40	V
		$V_{IN} = 1.0\text{V}, I_{SINK} = 100\mu\text{A}$		0.06	0.30	V
Output Sink Current	I_{SINK}	$V_{IN}, \text{RESET} = 2.6\text{V}$			20	mA
Output Off-State Leakage		$V_{IN}, \text{RESET} = 3.6\text{V}$			0.5	μA
		$V_{IN}, \text{RESET} = 10\text{V}$			2.0	μA
Clamp Diode Forward Voltage	V_F	Pin 1 to pin 2, ($I_F = 5.0\text{mA}$)	0.5		1.2	V

3.3V UNDERVOLTAGE SENSING CIRCUIT

PRODUCTION DATA SHEET

GRAPH / CURVE INDEX

Characteristic Curves

FIGURE

1. COMPARATOR THRESHOLD VOLTAGE vs. TEMPERATURE
2. $\overline{\text{RESET}}$ OUTPUT VOLTAGE vs. INPUT VOLTAGE
3. $\overline{\text{RESET}}$ OUTPUT SATURATION vs. SINK CURRENT
4. INPUT CURRENT vs. INPUT VOLTAGE
5. $\overline{\text{RESET}}$ DELAY TIME (LOW to HIGH)
6. $\overline{\text{RESET}}$ DELAY TIME (HIGH to LOW)

FIGURE INDEX

Application Circuits

FIGURE

7. SWITCHING THE LOAD OFF WHEN BATTERY REACHES BELOW V_{TH}
8. LOW VOLTAGE MICROPROCESSOR RESET
9. VOLTAGE MONITOR

3.3V UNDERVOLTAGE SENSING CIRCUIT

PRODUCTION DATA SHEET

CHARACTERISTIC CURVES

FIGURE 1. — COMPARATOR THRESHOLD VOLTAGE vs. TEMPERATURE

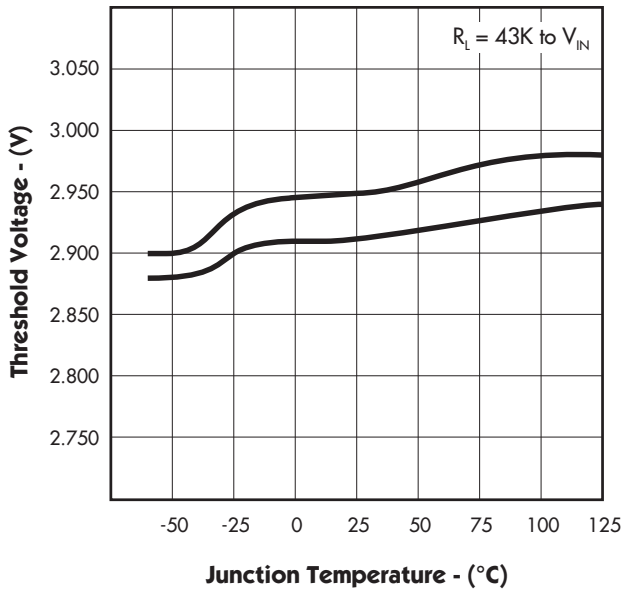

FIGURE 2. — RESET OUTPUT VOLTAGE vs. INPUT VOLTAGE

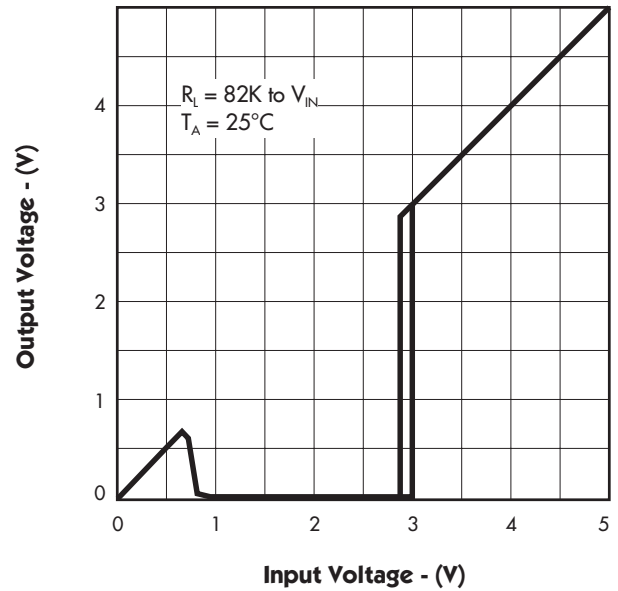

FIGURE 3. — RESET OUTPUT SATURATION vs. SINK CURRENT

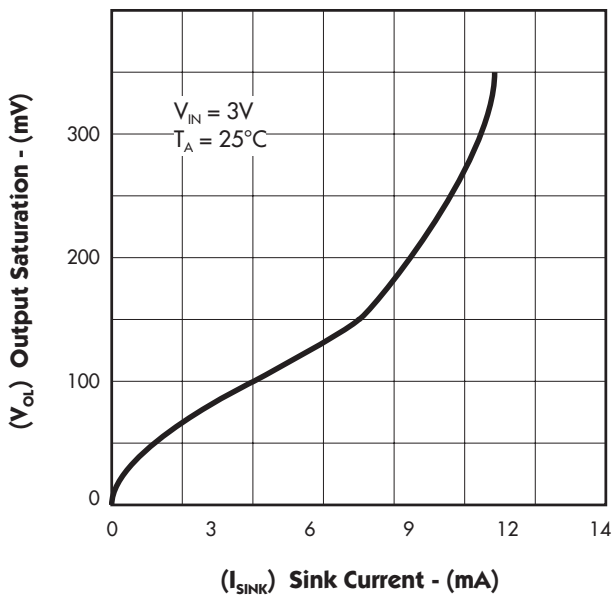
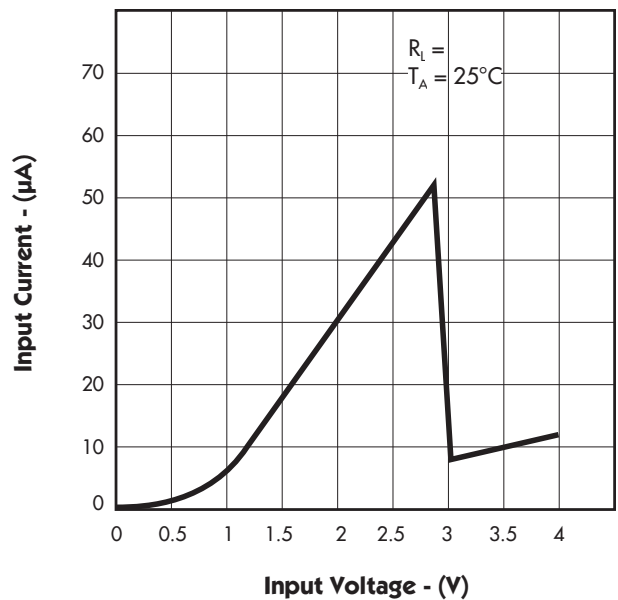

FIGURE 4. — INPUT CURRENT vs. INPUT VOLTAGE



3.3V UNDERVOLTAGE SENSING CIRCUIT

PRODUCTION DATA SHEET

CHARACTERISTIC CURVES

FIGURE 5. — $\overline{\text{RESET}}$ DELAY TIME (LOW TO HIGH)

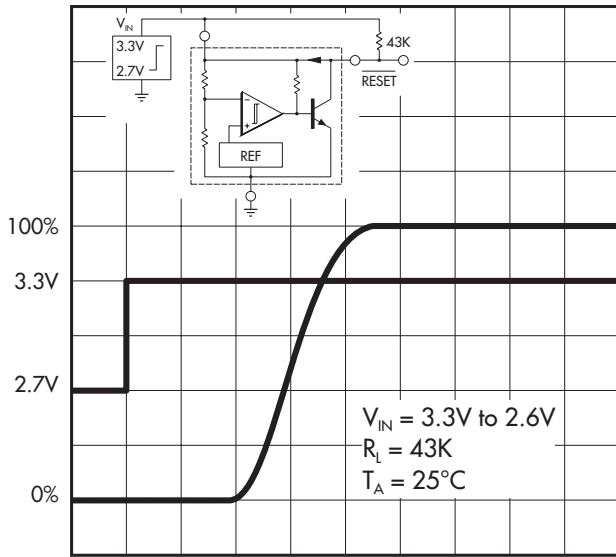

2 μ s/DIV.

FIGURE 6. — $\overline{\text{RESET}}$ DELAY TIME (HIGH TO LOW)

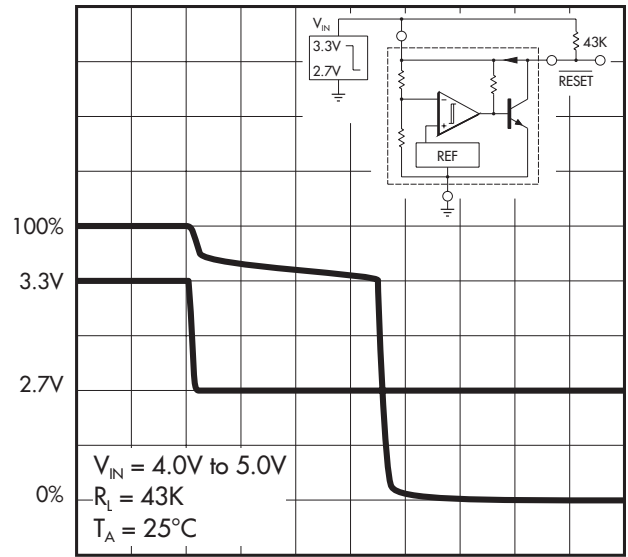

0.5 μ s/DIV.

3.3V UNDERVOLTAGE SENSING CIRCUIT

PRODUCTION DATA SHEET

TYPICAL APPLICATION CIRCUITS

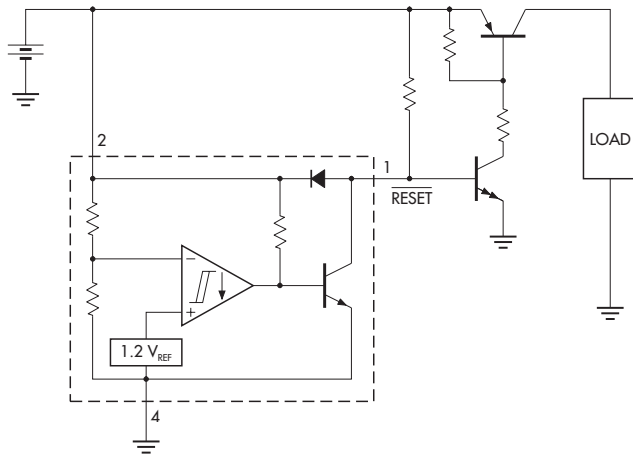
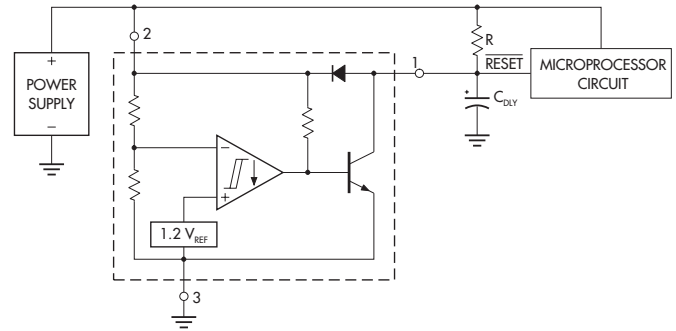

FIGURE 7. — SWITCHING THE LOAD OFF WHEN BATTERY VOLTAGE REACHES BELOW V_{TH}



A time-delayed reset can be accomplished with the addition of C_{DLY} . For systems with extremely fast power supply rise times ($< 500ns$), it is recommended that the RC_{DLY} time constant be greater than $5.0\mu s$. $V_{TH(MPU)}$ is the microprocessor reset input threshold.

$$t_{DLY} = R C_{DLY} \ln \left[\frac{1}{1 - \frac{V_{TH(MPU)}}{V_{IN}}} \right]$$

FIGURE 8. — LOW VOLTAGE MICROPROCESSOR RESET

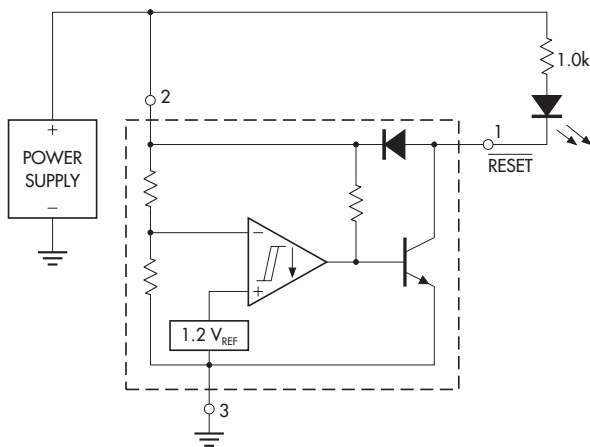

FIGURE 9. — VOLTAGE MONITOR