



M.S.KENNEDY CORP.

# HIGH CURRENT, SUPER LOW DROPOUT FIXED VOLTAGE REGULATORS

# 5010 SERIES

4707 Dey Road Liverpool, N.Y. 13088

(315) 701-6751

**FEATURES:**

- Extremely Low Dropout Voltage 0.45V @ 10 Amps
- Available in 3.3V, 5.0V and 12.0V versions
- Output Voltages Are Internally Set to  $\pm 1.5\%$  maximum
- TTL Level Enable Pin
- Electrically Isolated Case
- Low Quiescent Current
- Output Current to 10 Amps
- Available in Two Package Styles
- Available with Three Lead Form Options

**MIL-PRF-38534 QUALIFIED**

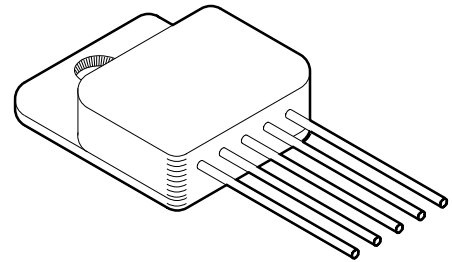

**DESCRIPTION:**

The MSK 5010 series voltage regulators are available in a +3.3V, +5.0V or +12.0V fixed output configuration. All three boast ultra low dropout specifications due to the utilization of a MOSFET output pass transistor with extremely low  $R_{ds(on)}$ . Dropout voltages of 0.45V at 10 amps are typical, in this configuration, which drives efficiency up and power dissipation down. Accuracy is guaranteed with a 1.5% maximum initial output voltage tolerance that varies only  $\pm 2\%$  with temperature. The MSK 5010 series is packaged in a space efficient 5 pin SIP that is electrically isolated from the internal circuitry allowing direct heat sinking for maximum heat dissipation.

**EQUIVALENT SCHEMATIC**

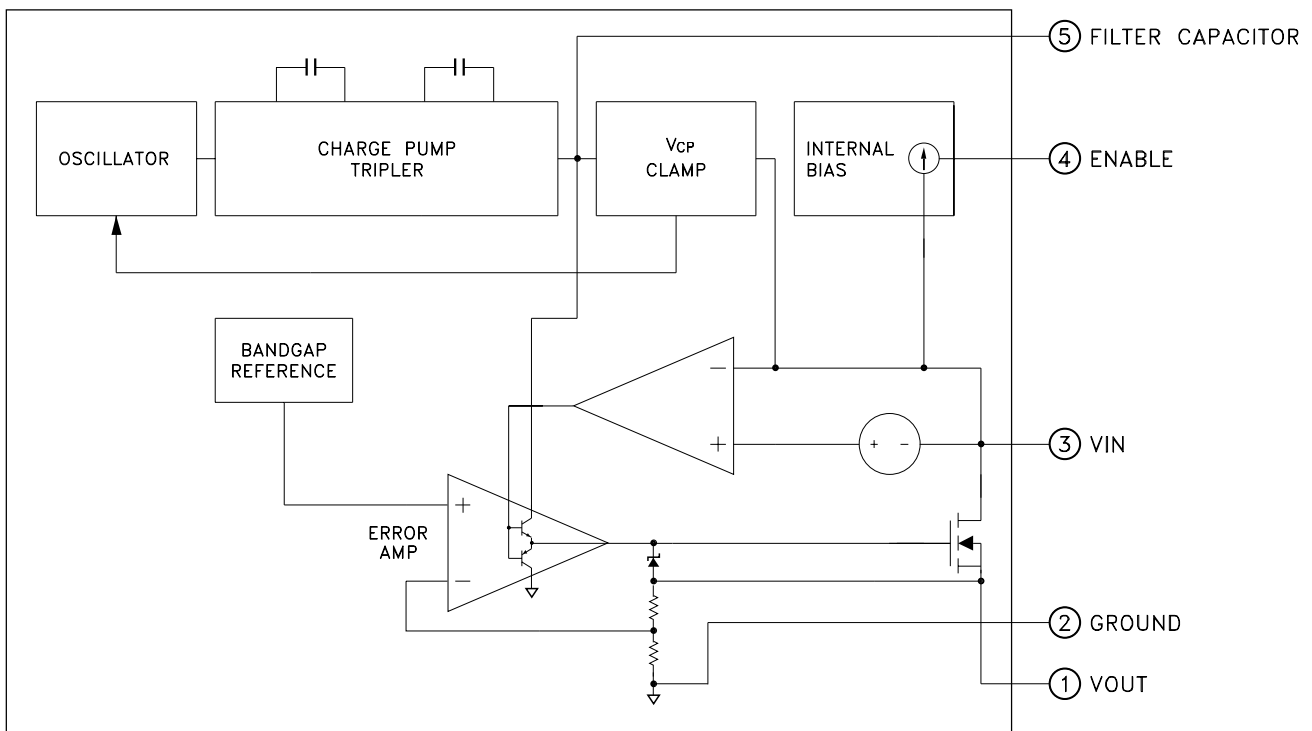

**TYPICAL APPLICATIONS**

- High Efficiency, High Current Linear Regulators
- Constant Voltage/Current Regulators
- System Power Supplies
- Switching Power Supply Post Regulators

## ABSOLUTE MAXIMUM RATINGS

$V_{IN}$	Input Voltage (WRT $V_{OUT}$ )	36V
$V_{EN}$	Enable Voltage	-0.3V to 36V
$I_{OUT}$	Output Current	10A within SOA
$T_J$	Junction Temperature	+175°C

$T_{ST}$	Storage Temperature Range	-65°C to +150°C
$T_{LD}$	Lead Temperature Range (10 Seconds)	300°C
$T_C$	Case Operating Temperature	-55°C to +125°C

## ELECTRICAL SPECIFICATIONS

Parameter	Test Conditions ③	Group A Subgroup	MSK 5010(B) SERIES			MSK 5010 SERIES			Units
			Min.	Typ.	Max.	Min.	Typ.	Max.	
Output Voltage Tolerance	$I_{OUT} = 100mA$ ; $V_{IN} = V_{OUT} + 3V$	1	-	±0.3	±1.5	-	±0.5	±1.5	%
		2,3	-	±1.0	±2.0	-	-	-	%
Dropout Voltage ②	$I_{OUT} = 0A$	1	-	0.002	0.010	-	0.002	0.015	V
	$I_{OUT} = 10A$	1	-	0.45	0.75	-	0.5	1.0	V
Load Regulation	$V_{IN} = V_{OUT} + 3V$ $100mA \leq I_{OUT} \leq 9A$	1	-	±0.5	±1.0	-	±0.5	±1.5	%
		2,3	-	±0.5	±2.0	-	-	-	%
Line Regulation	$(V_{OUT} + 1.5V) \leq V_{IN} \leq (V_{OUT} + 15V)$ $I_{OUT} = 100mA$	1	-	±0.3	±1.0	-	±0.5	±1.5	%
		2,3	-	±0.5	±1.0	-	-	-	%
Quiescent Current	$V_{EN} = V_{IN}$ ; $V_{IN} = V_{OUT} + 3V$ ; $I_{OUT} = 0A$	1,2,3	-	4.5	10	-	4.5	10	mA
	② $V_{EN} = 0V$ ; $V_{IN} = V_{OUT} + 3V$ ; $I_{OUT} = 0A$	1,2,3	-	0.15	5.0	-	0.15	5.0	μA
Ripple Rejection ②	$f = 120Hz$	-	-	45	-	-	45	-	dB
Thermal Resistance ②	Junction to Case	-	-	0.7	0.8	-	0.7	1.0	°C/W
Enable Input Voltage ②	HIGH	1	2.4	1.2	-	2.4	1.2	-	V
	LOW	1	-	1.2	0.8	-	1.2	0.8	V
Enable Input Current ②	HIGH	1	-	12.5	50	-	20	50	μA
	LOW	1	-	0.8	25	-	10	25	μA
Output Settling Time ② ⑧	To within 10mV	-	-	5	-	-	5	-	μS

### NOTES:

- ① Output decoupled to ground using 20μF minimum capacitor unless otherwise specified.
- ② This parameter is guaranteed by design but need not be tested.
- ③ Typical parameters are representative of actual device performance but are for reference only.
- ④ All output parameters are tested using a low duty cycle pulse to maintain  $T_J = T_C$ .
- ⑤ Industrial grade devices shall be tested to subgroup 1 unless otherwise specified.
- ⑥ Military grade devices ('B' suffix) shall be 100% tested to subgroups 1,2 and 3.
- Subgroup 1  $T_A = T_C = +25^\circ C$
- ⑦ Subgroup 2  $T_A = T_C = +125^\circ C$
- ⑧ Subgroup 3  $T_A = T_C = -55^\circ C$

Please consult the factory if alternate output voltages are required.  
After application of enable pulse

PART ⑦ NUMBER	OUTPUT VOLTAGE
MSK5010-3.3	+3.3V
MSK5010-5.0	+5.0V
MSK5010-12	+12.0V

## APPLICATION NOTES

### MINIMIZING OUTPUT RIPPLE:

The output voltage ripple of the MSK 5010 series voltage regulators can be minimized by placing a filter capacitor from the output to ground. The optimum value for this capacitor may vary from one application to the next and is best determined by experimentation. Transient load response can also be improved by placing a (10uF to 20uF) capacitor directly across the load.

### CASE CONNECTIONS:

The case of the MSK 5010 is electrically isolated from the internal circuitry so that a direct connection can be made to the heat sink for most efficient heat dissipation. However, it may be necessary in some applications to connect the case to ground. Grounding the case will help eliminate oscillations and produce a clean, noise free output.

### LOAD REGULATION:

For best results, the ground pin should be connected directly to the load (see next note). This effectively reduces the ground loop effect and eliminates excessive voltage drop in the sense leg. It is also important to keep the output connection between the regulator and the load as short as possible since this directly affects the load regulation. For example, if 20 gauge wire were used which has a resistance of about .008 ohms per foot, this would result in a drop of 8mV/ft at a load current of 1 amp.

### LOAD CONNECTIONS:

In voltage regulator applications where very large load currents are present, the load connection is very important. The path connecting the output of the regulator to the load must be extremely low impedance to avoid affecting the load regulation specifications. Any impedance in this path will form a voltage divider with the load. The same holds true for the connection from the low end of the load to ground. For best load regulation, the low end of the load must be connected directly to pin 2 of the MSK 5010 and not to a ground plane inches away from the hybrid.

### ENABLE/SHUTDOWN PIN:

The MSK 5010 series of voltage regulators are equipped with a TTL compatible ENABLE pin. A TTL high level on this pin activates the internal bias circuit and powers up the device. A TTL low level on this pin places the controller in shutdown mode and the device draws a maximum of 5μA of quiescent current.

### CHARGE CAPACITOR:

For all applications, the user must connect a 1.0uF capacitor from pin 5 directly to ground. This capacitor is part of the circuit which drives the gate of the internal MOSFET. Approximately three times the voltage seen on the input will appear across this capacitor. Careful attention must be paid to capacitor voltage rating since voltages larger than the power supply are present.

### HEAT SINK SELECTION:

To select a heat sink for the MSK 5010, the following formula for convective heat flow must be used.

Governing Equation:

$$T_j = P_d \times (R_{\theta jc} + R_{\theta cs} + R_{\theta sa}) + T_a$$

WHERE:

$T_j$  = Junction Temperature

$P_d$  = Total Power Dissipation

$R_{\theta jc}$  = Junction to Case Thermal Resistance

$R_{\theta cs}$  = Case to Heat Sink Thermal Resistance

$R_{\theta sa}$  = Heat Sink to Ambient Thermal Resistance

$T_a$  = Ambient Temperature

First, the power dissipation must be calculated as follows:

$$\text{Power Dissipation} = (V_{in} - V_{out}) \times I_{out}$$

Next, the user must select a maximum junction temperature. The absolute maximum allowable junction temperature is 175°C. The equation may now be rearranged to solve for the required heat sink to ambient thermal resistance ( $R_{\theta sa}$ ).

EXAMPLE;

An MSK 5010-3.3 is configured for  $V_{in} = +7V$  and  $V_{out} = +3.3V$ .  $I_{out}$  is a continuous 10A DC level. The ambient temperature is +25°C. The maximum desired junction temperature is 150°C.  $R_{\theta jc} = 0.8^\circ C/W$  and  $R_{\theta cs} = 0.15^\circ C/W$  typically.

$$\begin{aligned} \text{Power Dissipation} &= (7V - 3.3V) \times (10A) \\ &= 37 \text{ Watts} \end{aligned}$$

Solve for  $R_{\theta sa}$ :

$$R_{\theta sa} = \left[ \frac{150^\circ C - 25^\circ C}{37W} \right] - 0.8^\circ C/W - 0.15^\circ C/W$$

In this example, a heat sink with a thermal resistance of no more than 2.43°C/W must be used to maintain a junction temperature of no more than 150°C. The Thermalloy Corporation makes a heat sink with a thermal resistance of 2.2°C/W that would work well for this application. (See Thermalloy part number 7023)

### POWER DISSIPATION:

The output pass transistor in the MSK 5010 is rated to dissipate nearly 100 watts. The limiting factor of this device is effective dissipation of heat generated under such conditions. For example, to dissipate 100 watts, calculations show that the MSK 5010 would have to be bolted to the underbelly of a submarine submerged in the Arctic Ocean! Careful consideration must be paid to heat dissipation and junction temperature when applying this device.

# TYPICAL PERFORMANCE CURVES

DROPOUT VOLTAGE vs OUTPUT CURRENT

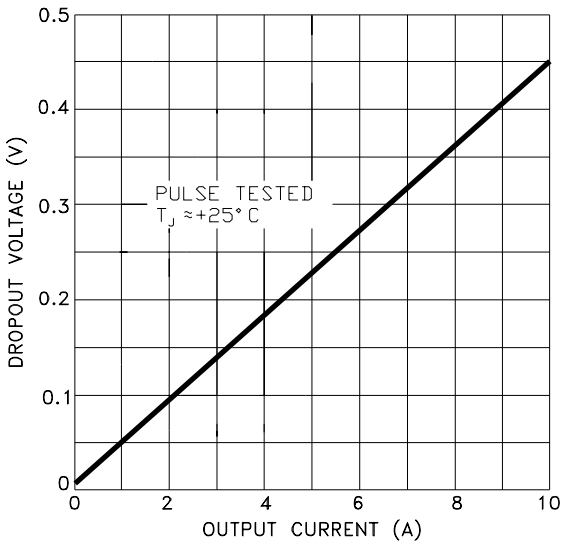

LINE REGULATION

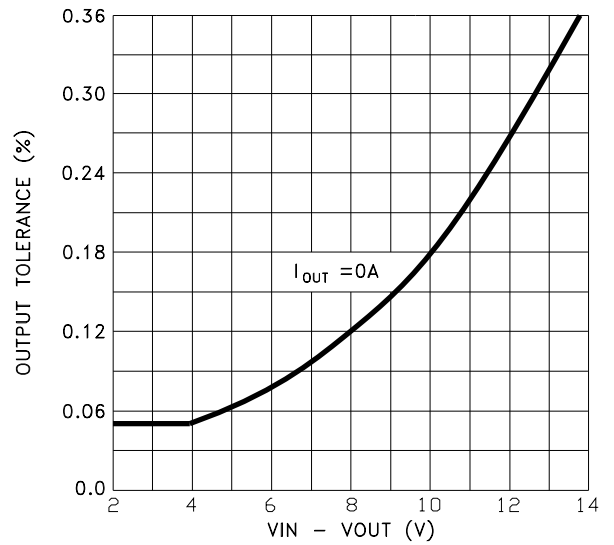

RIPPLE REJECTION vs FREQUENCY

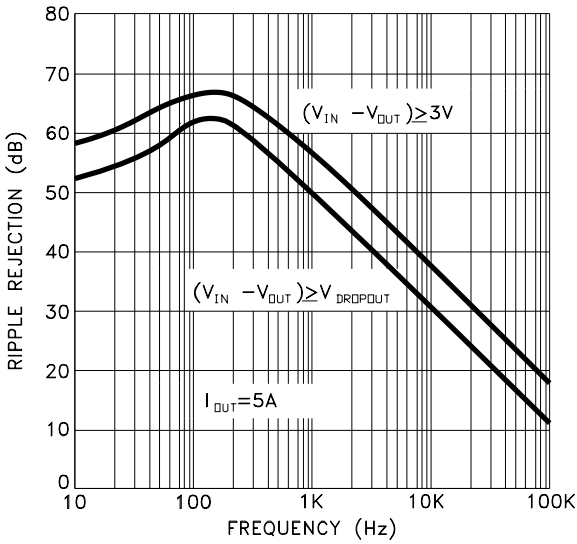

LOAD REGULATION

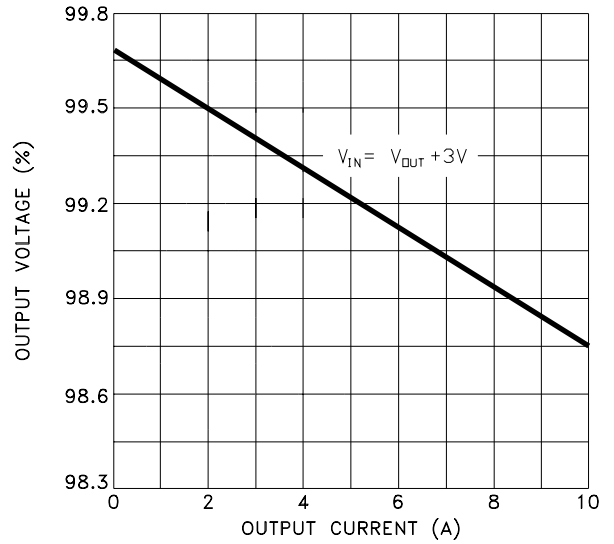

POWER DISSIPATION vs AMBIENT TEMPERATURE vs THERMAL RESISTANCE OF HEAT SINK CHOSEN

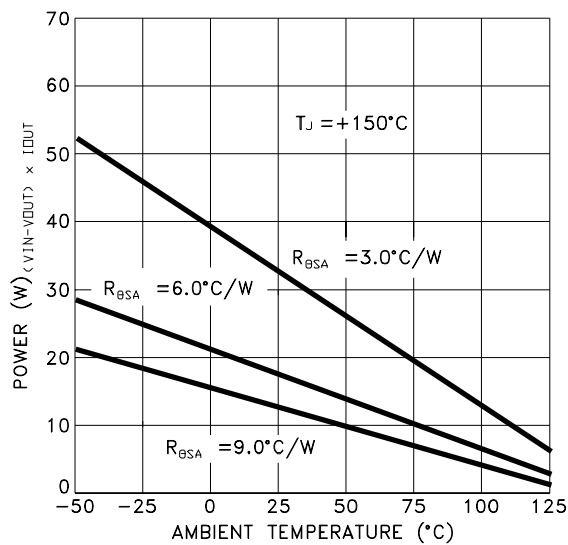

## MECHANICAL SPECIFICATIONS

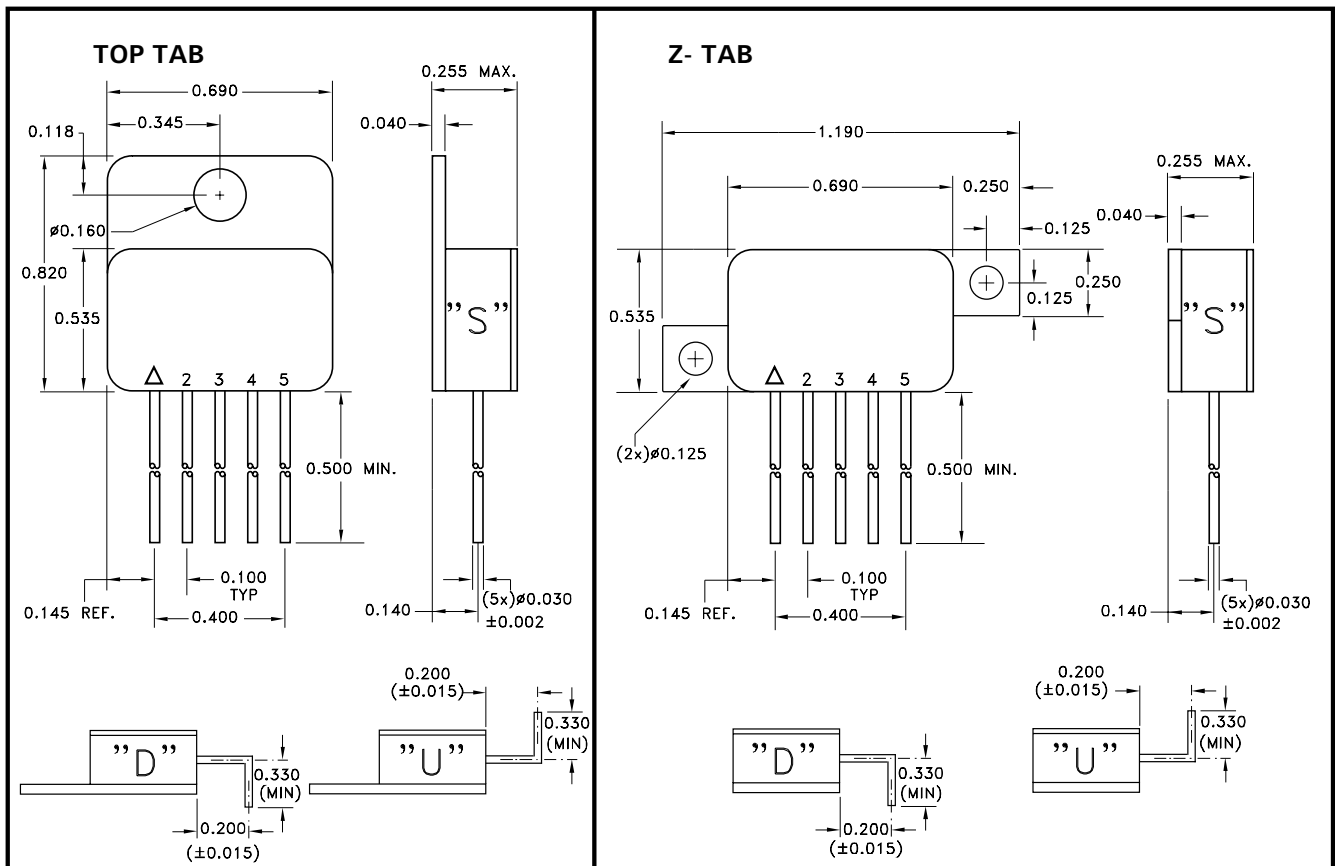

NOTE: ALL DIMENSIONS ARE  $\pm 0.010$  INCHES UNLESS OTHERWISE LABELED.  
ESD Triangle indicates Pin 1.

## ORDERING INFORMATION

MSK5010-3.3 B T U

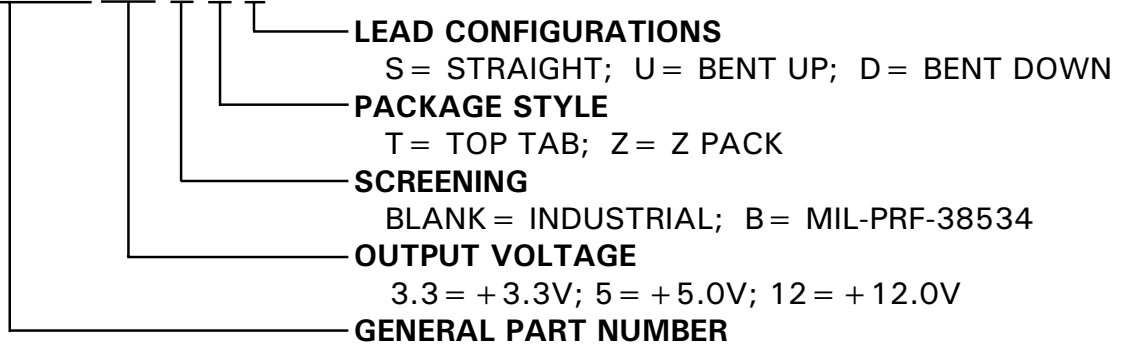

The above example is a +3.3V, Military regulator using the top tab package with leads bent up.

M.S. Kennedy Corp.  
4707 Dey Road, Liverpool, New York 13088  
Phone (315) 701-6751  
FAX (315) 701-6752  
www.mskennedy.com

The information contained herein is believed to be accurate at the time of printing. MSK reserves the right to make changes to its products or specifications without notice, however, and assumes no liability for the use of its products.