



M.S.KENNEDY CORP.

VERY HIGH CURRENT, LOW DROPOUT VOLTAGE REGULATORS

5175 SERIES

4707 Dey Road Liverpool, N.Y. 13088

(315) 701-6751

FEATURES:

- Electrically Isolated Top Tab or Z Tab SIP
- Extremely Low Dropout Voltage: 425mV @ 7.5 Amps
- Available in 3.3V, 5.0V, 12.0V and Adjustable Versions
- Open Collector Error Flag Output
- TTL Level Enable Pin: Zero Current Shutdown Mode
- Reverse Battery and Load Dump Protection
- Low Ground Current: 120mA Typical at Full Load
- 1% Maximum Guaranteed Accuracy
- Output Current to 7.5 Amps

MIL-PRF-38534 QUALIFIED

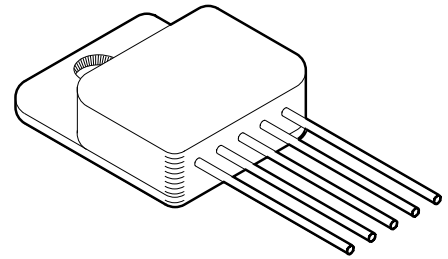

DESCRIPTION:

The MSK 5175 series voltage regulators are available in +3.3V, +5.0V, +12.0V or adjustable output configurations. All boast ultra low dropout specifications due to the utilization of a super PNP output pass transistor with monolithic technology. Dropout voltages of 425mV at 7.5 amps are typical in this configuration, which drives efficiency up and power dissipation down. Accuracy is guaranteed with a 1% maximum output voltage tolerance. The series also offers a TTL/CMOS compatible on/off enable function as well as an output flag pin. The MSK 5175 series is packaged in a space efficient 5 pin power SIP available in two styles with three lead bend options.

EQUIVALENT SCHEMATIC

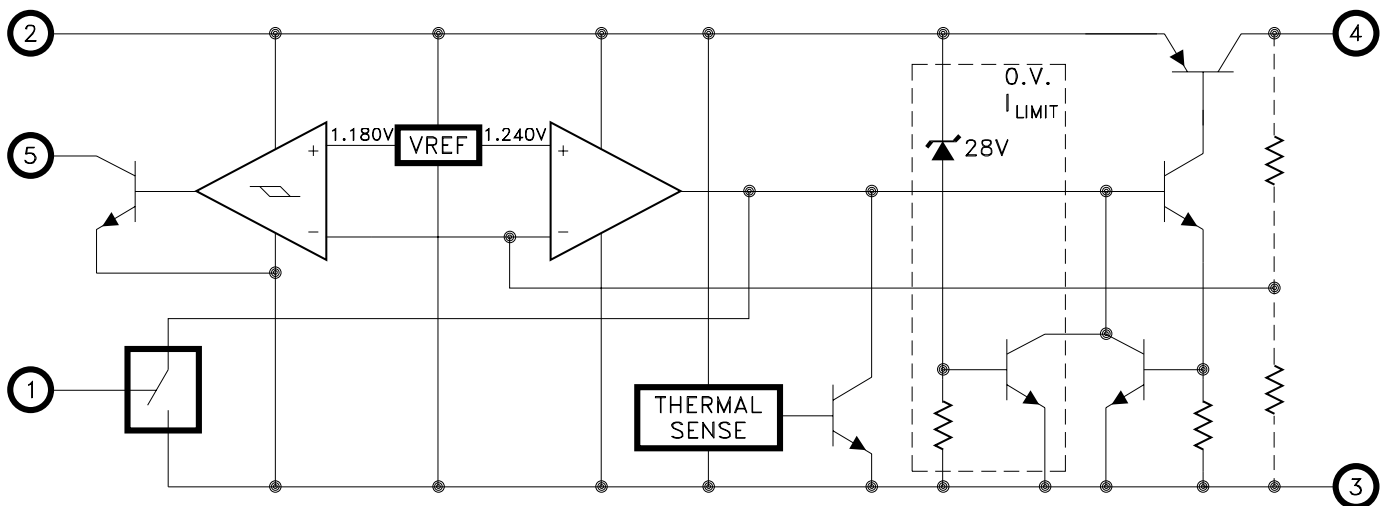

Schematic shown for fixed output voltage versions

TYPICAL APPLICATIONS

- High Efficiency, Ultra High Current Linear Regulators
- Constant Voltage/Current Regulators
- System Power Supplies
- Switching Power Supply Post Regulators
- Battery Powered Equipment

PIN-OUT INFORMATION

MSK5175-00	MSK5175-3.3,-5.0,-12
1 Enable	1 Enable
2 Vin	2 Vin
3 Ground	3 Ground
4 Vout	4 Vout
5 Adjust	5 Flag

ABSOLUTE MAXIMUM RATINGS

V_{INP}	Input Voltage (100ms 1%D.C.)	-20V to +60V
V_{IN}	Input Voltage	26V
V_{EN}	Enable Voltage	-0.3V to 26V
I_{OUT}	Output Current	8A

T_{ST}	Storage Temperature Range	-65°C to +150°C
T_{LD}	Lead Temperature (10 Seconds Soldering)	300°C
T_J	Operating Temperature	MSK 5175 Series: -40°C to +85°C MSK 5175B Series: -55°C to +125°C

ELECTRICAL SPECIFICATIONS

Parameter	Test Conditions ① ③	Group A Subgroup	MSK 5175B SERIES			MSK 5175 SERIES			Units
			Min.	Typ.	Max.	Min.	Typ.	Max.	
Output Voltage Tolerance	$I_{OUT} = 10mA$; $V_{IN} = V_{OUT} + 1V$	1	-	± 0.5	± 1.0	-	± 0.5	± 1.0	%
		2,3	-	± 1.0	± 2.0	-	-	-	%
Dropout Voltage	② $\Delta V_{OUT} = -1\%$; $I_{OUT} = 250mA$	1	-	80	200	-	80	225	mV
	② $\Delta V_{OUT} = -1\%$; $I_{OUT} = 7.5A$	1	-	425	600	-	425	625	mV
Load Regulation	$V_{IN} = V_{OUT} + 5V$ $10mA \leq I_{OUT} \leq 7.5A$	1	-	± 0.2	± 1.0	-	± 0.2	± 1.2	%
		2,3	-	± 0.3	± 2.0	-	± 0.3	-	%
Line Regulation	$(V_{OUT} + 1V) \leq V_{IN} \leq 26V$ $I_{OUT} = 10mA$	1	-	± 0.05	± 0.5	-	± 0.05	± 0.6	%
		2,3	-	± 0.5	± 1.0	-	± 0.5	-	%
Output Current Limit ②	$V_{OUT} = 0V$; $V_{IN} = V_{OUT} + 1V$	-	-	9.5	15	-	9.5	15	A
Ground Current ②	$V_{IN} = V_{OUT} + 1V$; $I_{OUT} = 4A$	-	-	35	75	-	35	80	mA
	$V_{IN} = V_{OUT} + 1V$; $I_{OUT} = 7.5A$	-	-	120	-	-	120	-	mA
Output Noise ②	$C_L = 33\mu F$; $10Hz \leq f \leq 100KHz$	-	-	260	-	-	260	-	μV
Enable Input Voltage ②	HIGH/ON	1	2.4	1.2	-	2.4	1.2	-	V
	LOW/OFF	1	-	1.2	0.8	-	1.2	0.8	V
Enable Input Current ②	HIGH/ON	1	-	20	75	-	20	75	μA
	LOW/OFF	1	-	1	2	-	1	2	μA
Shutdown Output Current ②	$V_{ENABLE} \leq 0.8V$	-	-	10	20	-	10	20	μA
Flag Output Leakage ② ⑨	$V_{OH} = 26V$	-	-	0.01	2	-	0.01	2	μA
Flag Output On Voltage ⑨	$I_{OL} \leq 250\mu A$; $V_{IN} = V_{OUT} - 2V$	1	-	0.2	0.4	-	0.2	0.4	V
Flag Threshold ② ⑨	$V_{IN} = V_{OUT} - 7\%$	-	-	75	-	-	75	-	mV
Reference Voltage ⑧	Normal Operation	1	1.22	1.24	1.26	1.22	1.24	1.26	V
Reference Voltage Temp Drift ② ⑧	Normal Operation	-	-	20	-	-	20	-	ppm/°C
Adjust Pin Bias Current ② ⑧	Full Temp; $V_{IN} = V_{OUT} + 1V$	-	-	40	120	-	40	150	nA
Thermal Resistance ②	Junction to Case	-	-	0.9	1.3	-	0.9	1.5	°C/W
Thermal Shutdown ②	T_J	-	-	135	-	-	135	-	°C

NOTES:

- ① Output decoupled to ground using 33 μF minimum capacitor unless otherwise specified.
- ② This parameter is guaranteed by design but need not be tested.
Typical parameters are representative of actual device performance but are for reference only.
- ③ All output parameters are tested using a low duty cycle pulse to maintain $T_J = T_C$.
- ④ Industrial grade devices shall be tested to subgroup 1 unless otherwise specified.
- ⑤ Military grade devices ('B' suffix) shall be 100% tested to subgroups 1,2 and 3.
- ⑥ Subgroup 1 $T_C = +25^\circ C$
Subgroup 2 $T_J = +125^\circ C$
Subgroup 3 $T_A = -55^\circ C$
- ⑦ Please consult the factory if alternate output voltages are required.
- ⑧ Applies to MSK5175-00 adjustable version only.
- ⑨ Applies to fixed output devices only.

PART NUMBER	OUTPUT VOLTAGE
MSK5175-00	Adjustable
MSK5175-3.3	+ 3.3V
MSK5175-5.0	+ 5.0V
MSK5175-12	+ 12.0V

APPLICATION NOTES

REGULATOR PROTECTION:

The MSK 5175 series is fully protected against reversed input polarity, overcurrent faults, overtemperature conditions (Pd) and transient voltage spikes of up to 60V. If the regulator is used in dual supply systems where the load is returned to a negative supply, the output voltage must be diode clamped to ground.

OUTPUT CAPACITOR:

The output voltage ripple of the MSK 5175 series voltage regulators can be minimized by placing a filter capacitor from the output to ground. The optimum value for this capacitor may vary from one application to the next, but a minimum of 33µF is recommended for optimum performance. Transient load response can also be improved by placing a capacitor directly across the load.

LOAD CONNECTIONS:

In voltage regulator applications where very large load currents are present, the load connection is very important. The path connecting the output of the regulator to the load must be extremely low impedance to avoid affecting the load regulation specifications. Any impedance in this path will form a voltage divider with the load. The MSK 5175 series requires a minimum of 10mA of load current to stay in regulation.

ENABLE PIN:

The MSK 5175 series of voltage regulators are equipped with a TTL compatible ENABLE pin. A TTL high level on this pin activates the internal bias circuit and powers up the device. A TTL low level on this pin places the controller in shutdown mode and the device draws only 5µA of quiescent current. If the enable function is not used, simply connect the enable pin to the input.

FLAG OUTPUT PIN:

All of the fixed output voltage versions of the MSK 5175 series are equipped with a flag output pin. Since the flag pin is an open collector configuration it can be pulled up to any voltage between 3V and 26V. This feature allows direct interfacing to practically any logic. This active low output has a typical level of 0.22V when the flag comparator detects an "out of regulation" condition. Flag states include low input voltage, out of regulation and output current limit. Extremely high level input voltage transients will also cause the flag output pin to activate.

DEVICE/CASE CONNECTION:

The MSK 5175 series are highly thermally conductive devices and the thermal path from the package heat sink to the internal junctions is very short. Since the case is electrically isolated from the internal circuitry, the package can be directly connected to a heat sink.

HEAT SINK SELECTION:

To select a heat sink for the MSK 5175, the following formula for convective heat flow may be used.

Governing Equation:

$$T_j = P_d \times (R_{\theta jc} + R_{\theta cs} + R_{\theta sa}) + T_a$$

WHERE:

T_j = Junction Temperature

P_d = Total Power Dissipation

$R_{\theta jc}$ = Junction to Case Thermal Resistance

$R_{\theta cs}$ = Case to Heat Sink Thermal Resistance

$R_{\theta sa}$ = Heat Sink to Ambient Thermal Resistance

T_a = Ambient Temperature

First, the power dissipation must be calculated as follows:

$$\text{Power Dissipation} = (V_{in} - V_{out}) \times I_{out}$$

Next, the user must select a maximum junction temperature. The absolute maximum allowable junction temperature is 125°C. The equation may now be rearranged to solve for the required heat sink to ambient thermal resistance ($R_{\theta sa}$).

EXAMPLE;

An MSK 5175-3.3 is configured for $V_{in} = +5V$ and $V_{out} = +3.3V$. I_{out} is a continuous 1A DC level. The ambient temperature is +25°C. The maximum desired junction temperature is 125°C.

$R_{\theta jc} = 1.3^\circ\text{C/W}$ and $R_{\theta cs} = 0.5^\circ\text{C/W}$ typically.

$$\begin{aligned} \text{Power Dissipation} &= (5V - 3.3V) \times (1A) \\ &= 1.7 \text{ Watts} \end{aligned}$$

Solve for $R_{\theta sa}$:

$$\begin{aligned} R_{\theta sa} &= \left[\frac{125^\circ\text{C} - 25^\circ\text{C}}{1.7\text{W}} \right] - 1.3^\circ\text{C/W} - 0.5^\circ\text{C/W} \\ &= 57.02^\circ\text{C/W} \end{aligned}$$

In this example, a heat sink with a thermal resistance of no more than 57°C/W must be used to maintain a junction temperature of no more than 125°C.

MSK5175-00 OUTPUT ADJUSTMENT:

The MSK 5175-00 is an adjustable version in the series of high performance regulators. The diagram below illustrates proper adjustment technique for the output voltage. The series resistance of $R_1 + R_2$ should be selected to pass the minimum regulator output current requirement of 10mA.

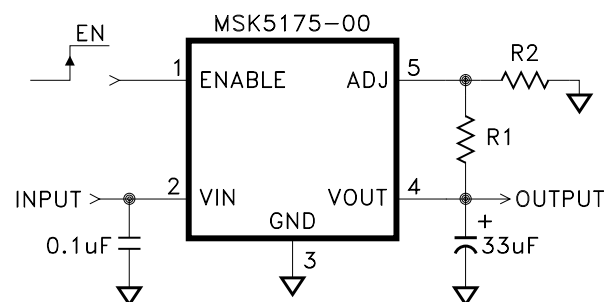

$$V_{OUT} = 1.240V \times [1 + (R_1/R_2)]$$

TYPICAL PERFORMANCE CURVES

DROPOUT vs OUTPUT CURRENT

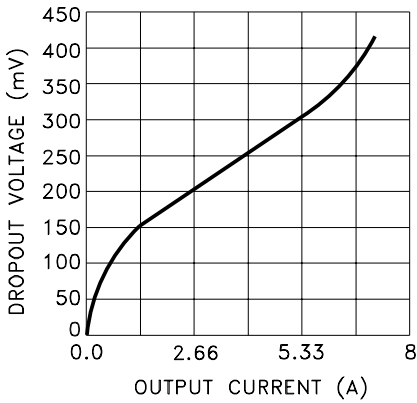

DROPOUT vs TEMPERATURE

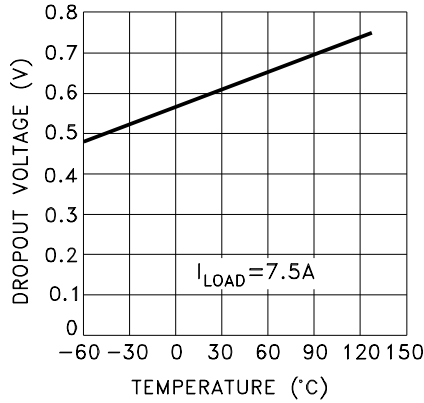

GROUND CURRENT vs. OUTPUT CURRENT

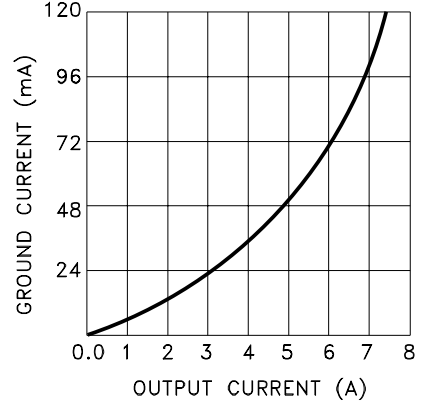

GROUND CURRENT vs. TEMPERATURE

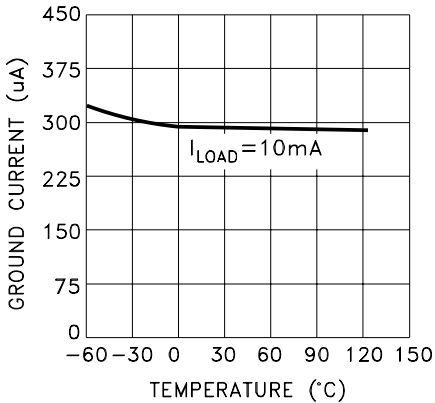

SHORT CIRCUIT CURRENT vs. TEMP.

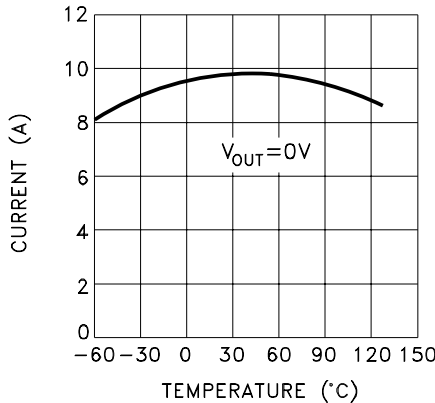

ENABLE CURRENT vs. TEMPERATURE

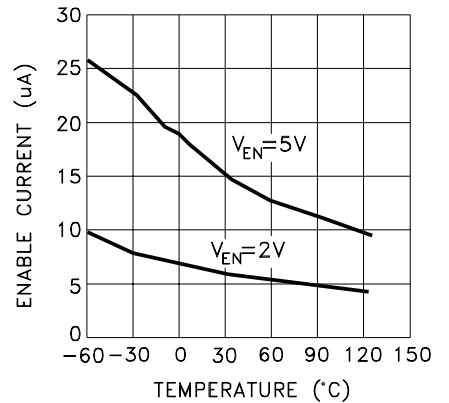

LOAD TRANSIENT RESPONSE

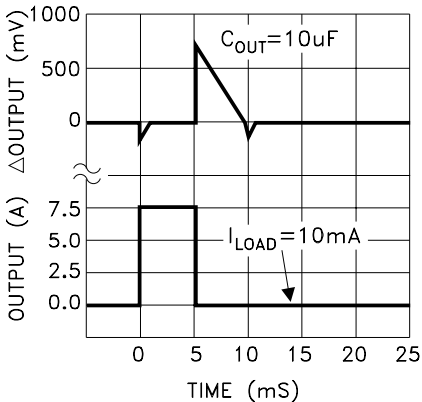

ADJUST PIN CURRENT vs. TEMP.

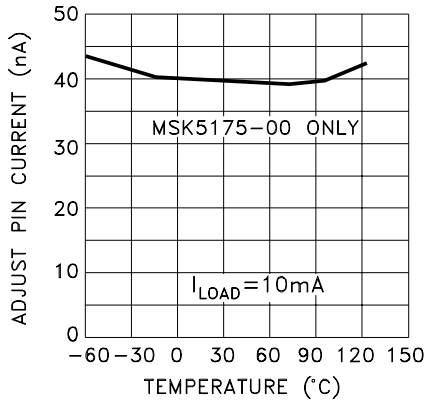

LINE TRANSIENT RESPONSE

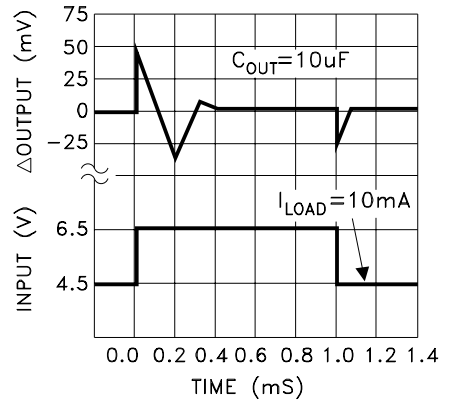

OUTPUT IMPEDANCE vs. FREQUENCY

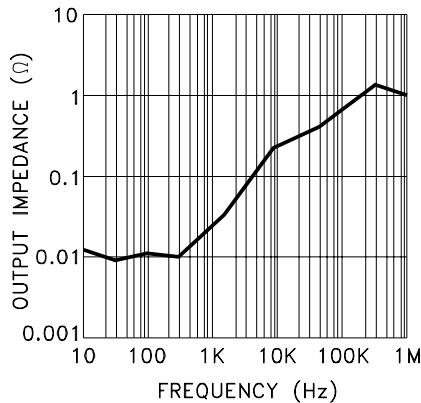

MECHANICAL SPECIFICATIONS

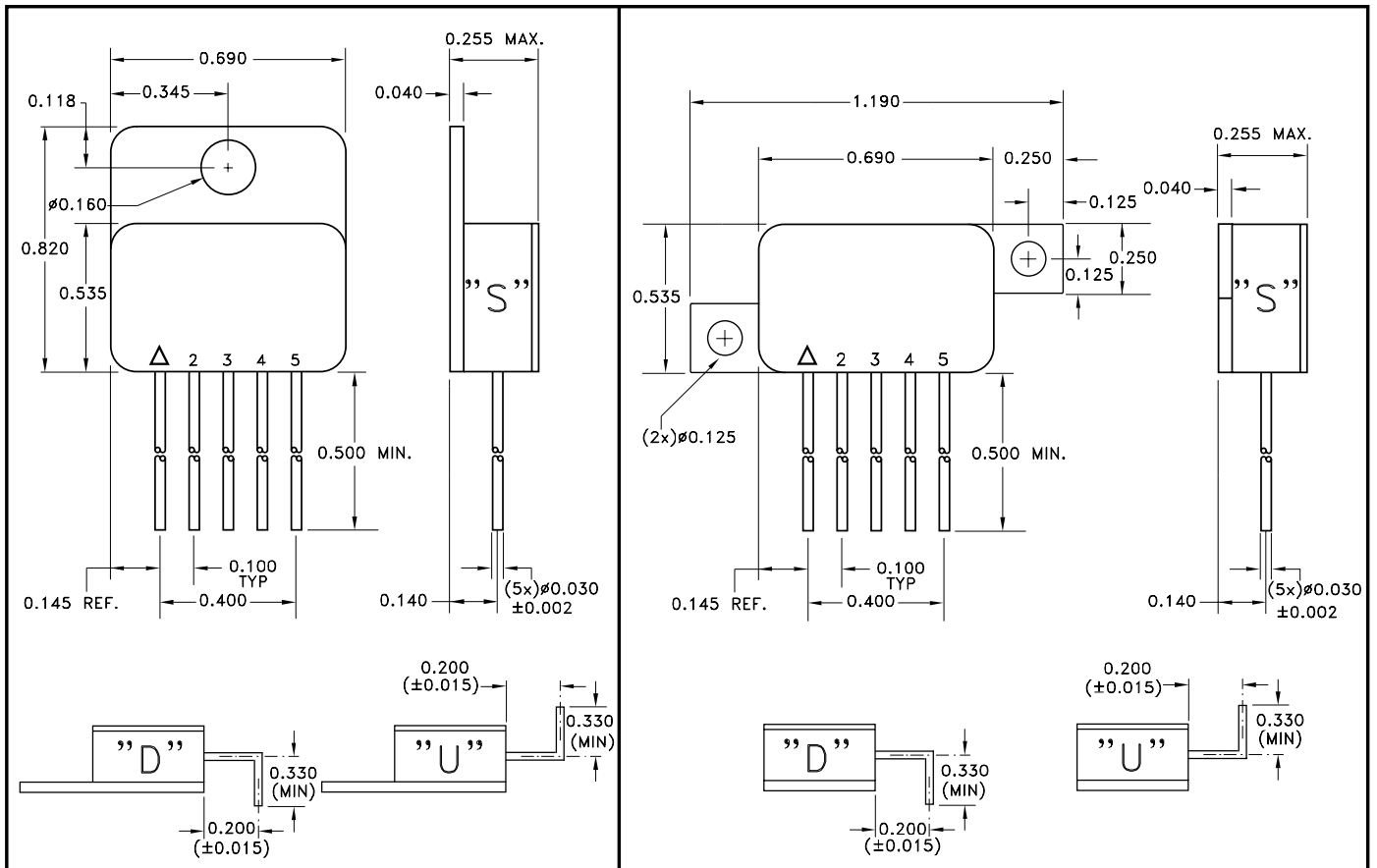

NOTE: ALL DIMENSIONS ARE ± 0.010 INCHES UNLESS OTHERWISE LABELED.
ESD Triangle indicates Pin 1.

ORDERING INFORMATION

MSK5175-3.3 B T U

LEAD CONFIGURATIONS

S = STRAIGHT; U = BENT UP; D = BENT DOWN

PACKAGE STYLE

T = TOP TAB; Z = Z PACK

SCREENING

BLANK = INDUSTRIAL; B = MIL-PRF-38534

OUTPUT VOLTAGE

00 = ADJ; 3.3 = +3.3V; 5.0 = +5.0V; 12 = +12.0V

GENERAL PART NUMBER

The above example is a +3.3V, Military regulator using the top tab package with leads bent up.

M.S. Kennedy Corp.
4707 Dey Road, Liverpool, New York 13088
Phone (315) 701-6751
FAX (315) 701-6752
www.mskennedy.com

The information contained herein is believed to be accurate at the time of printing. MSK reserves the right to make changes to its products or specifications without notice, however, and assumes no liability for the use of its products.