

FEATURES

1. Low on resistance for normally-closed type

This has been realized thanks to the built-in MOSFET processed by our proprietary method, DSD (Double-diffused and Selective Doping) method.

Cross section of the normally-closed type of power MOS

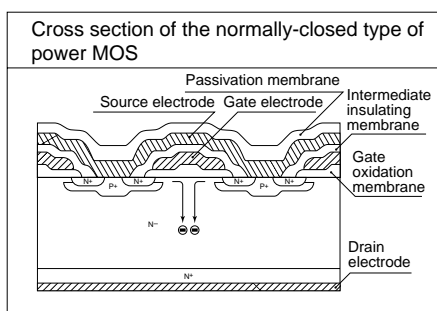

2. Reinforced insulation 5,000 V type

More than 0.4 mm internal insulation distance between inputs and outputs. Conforms to EN41003, EN60950 (reinforced insulation).

3. Compact 4-pin DIP size

The device comes in a compact (W)6.4×(L)4.78×(H)3.2mm (W).252×(L).188×(H).126inch, 4-pin DIP size

4. Controls low-level analog signals

PhotoMOS relays feature extremely low closed-circuit offset voltage to enable control of low-level analog signals without distortion.

5. High sensitivity, low ON resistance

Can control a maximum 0.13 A load current with a 5 mA input current. Low ON resistance of 18Ω (AQY410EH). Stable operation because there are no metallic contact parts.

6. Low-level off state leakage current

TYPICAL APPLICATIONS

- Modem
- Telephone equipment
- Security equipment
- Sensors

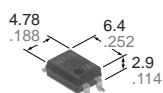
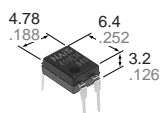

mm inch

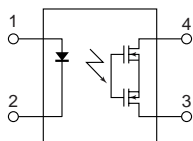

TYPES

Type	I/O isolation voltage	Output rating*		Part No.				Packing quantity	
				Through hole terminal	Surface-mount terminal				
		Load voltage	Load current		Tube packing style		Tape and reel packing style		Tube
AC/DC type	Reinforced 5,000 V	350 V	130 mA	AQY410EH	AQY410EHA	AQY410EHAX	AQY410EHAZ	1 tube contains 100 pcs. 1 batch contains 1,000 pcs.	
		400 V	120 mA	AQY414EH	AQY414EHA	AQY414EHAX	AQY414EHAZ		

*Indicate the peak AC and DC values.

Note: For space reasons, the initial letters of the product number "AQY", the SMD terminal shape indicator "A" and the package type indicator "X" and "Z" are omitted from the seal.

RATING

1. Absolute maximum ratings (Ambient temperature: 25°C 77°F)

Item		Symbol	AQY410EH (A)	AQY414EH (A)	Remarks
Input	LED forward current	I_F	50 mA		
	LED reverse voltage	V_R	3 V		
	Peak forward current	I_{FP}	1 A		f = 100 Hz, Duty factor = 0.1%
	Power dissipation	P_{in}	75 mW		
Output	Load voltage (peak AC)	V_L	350 V	400 V	
	Continuous load current	I_L	0.13 A	0.12 A	
	Peak load current	I_{peak}	0.4 A	0.3 A	100 ms (1 shot), $V_L = DC$
	Power dissipation	P_{out}	500 mW		
Total power dissipation		P_T	550 mW		
I/O isolation voltage		V_{iso}	5,000 V AC		
Temperature limits	Operating	T_{opr}	-40°C to +85°C -40°F to +185°F		Non-condensing at low temperatures
	Storage	T_{stg}	-40°C to +100°C -40°F to +212°F		

2. Electrical characteristics (Ambient temperature: 25°C 77°F)

Item		Symbol	AQY410EH (A)	AQY414EH (A)	Condition
Input	LED operate (OFF) current	Typical	1.4 mA	1.3 mA	I _L =Max.
		Maximum	3.0 mA		
	LED reverse (ON) current	Minimum	0.4 mA		I _L =Max.
		Typical	1.3 mA	1.2 mA	
LED dropout voltage	Typical	1.14 (1.25 V at I _F = 50 mA)		I _F = 5 mA	
	Maximum	1.5 V			
Output	On resistance	Typical	18Ω	26Ω	I _F = 0 mA I _L = Max. Within 1 s on time
		Maximum	25Ω	35Ω	
	Off state leakage current	Maximum	10μA		I _F = 5 mA V _L = Max.
Transfer characteristics	Operate (OFF) time*	Typical	1.0 ms	0.8 ms	I _F = 0 mA-->5 mA I _L = Max.
		Maximum	3.0 ms		
	Reverse (ON) time*	Typical	0.3 ms	0.2 ms	I _F = 5 mA-->0 mA I _L = Max.
		Maximum	1.0 ms		
	I/O capacitance	Typical	0.8 pF		f = 1MHz V _B = 0
Maximum		1.5 pF			
Initial I/O isolation resistance	Minimum	R _{iso}	1,000MΩ		500 V DC

Note: Recommendable LED forward current I_F = 5 to 10mA.

For type of connection, see page 32.

*Operate/Reverse time

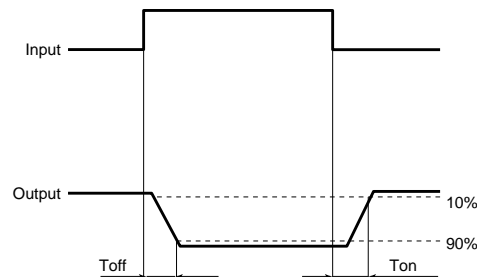

- For Dimensions, see Page 27.
- For Schematic and Wiring Diagrams, see Page 32.
- For Cautions for Use, see Page 36.

REFERENCE DATA

1. Load current vs. ambient temperature characteristics

Allowable ambient temperature: -40°C to +85°C
-40°F to +185°F

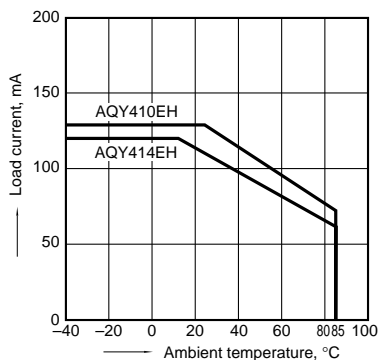

2. On resistance vs. ambient temperature characteristics

Measured portion: between terminals 3 and 4;
LED current: 0 mA; Load voltage: Max.(DC);
Continuous load current: Max. (DC)

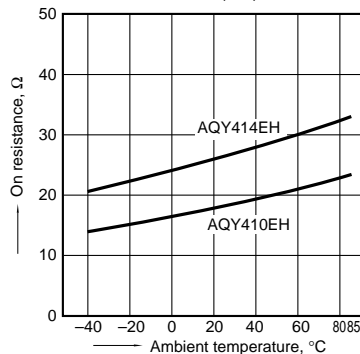

3. Operate (OFF) time vs. ambient temperature characteristics

LED current: 5 mA; Load voltage: Max. (DC);
Continuous load current: Max. (DC)

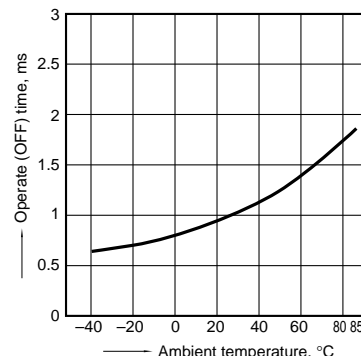

AQY410EH

4. Reverse (ON) time vs. ambient temperature characteristics

LED current: 5 mA; Load voltage: Max. (DC);
Continuous load current: Max. (DC)

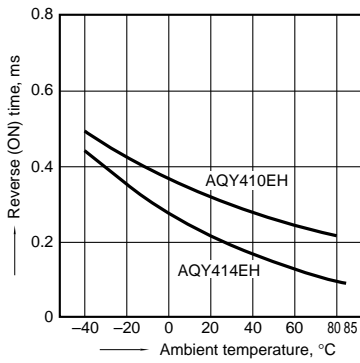

5. LED operate (OFF) current vs. ambient temperature characteristics

Load voltage: Max. (DC);
Continuous load current: Max. (DC)

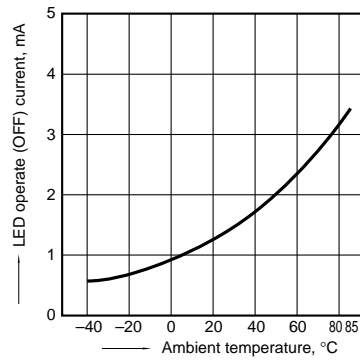

6. LED reverse (ON) current vs. ambient temperature characteristics

Load voltage: Max. (DC);
Continuous load current: Max. (DC)

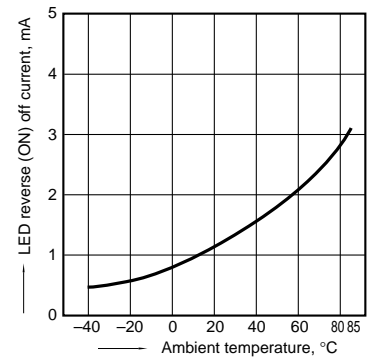

7. LED dropout voltage vs. ambient temperature characteristics

LED current: 5 to 50 mA

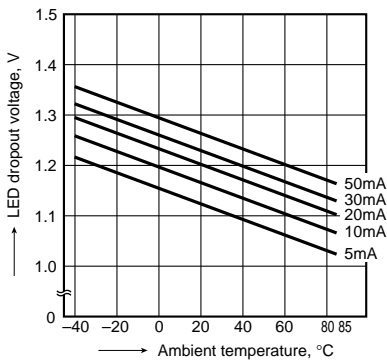

8. Voltage vs. current characteristics of output at MOS portion

Measured portion: between terminals 3 and 4;
Ambient temperature: 25°C 77°F

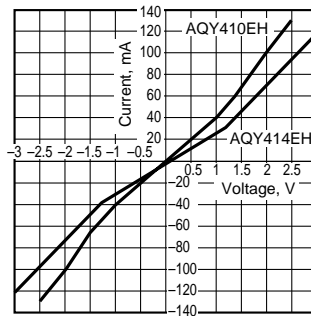

9. Off state leakage current

Measured portion: between terminals 3 and 4;
Ambient temperature: 25°C 77°F

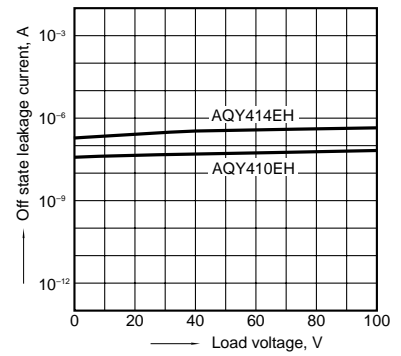

10. LED forward current vs. Operate (OFF) time characteristics

Measured portion: between terminals 3 and 4;
Load voltage: Max. (DC); Continuous load current: Max. (DC); Ambient temperature: 25°C 77°F

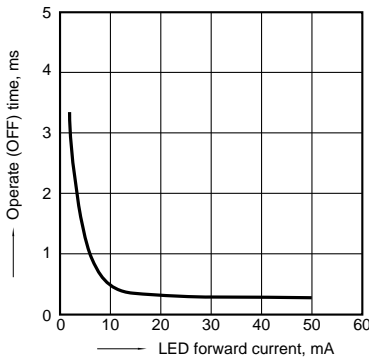

11. LED forward current vs. Reverse (ON) time characteristics

Measured portion: between terminals 3 and 4;
Load voltage: Max. (DC); Continuous load current: Max. (DC); Ambient temperature: 25°C 77°F

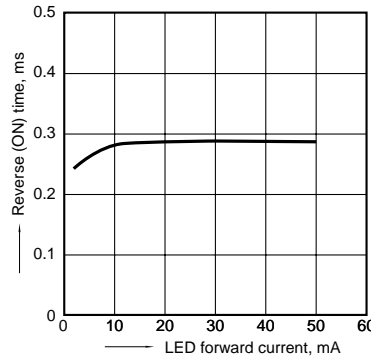

12. Applied voltage vs. output capacitance characteristics

Measured portion: between terminals 3 and 4;
Frequency: 1 MHz; Ambient temperature: 25°C 77°F

