

Nais

4 GHz 2 FORM C MICROWAVE RELAY

RM-RELAYS

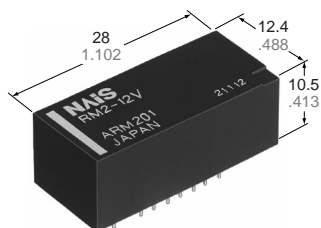

mm inch

- **Excellent high frequency characteristics**
Isolation: Min. 40dB (at 4 GHz)
Insertion loss Max. 1.0dB (at 4 GHz)
V.S.W.R.: Max. 1.5 (at 4 GHz)
- **High sensitivity in small size**
Size: 28.0 × 12.4 × 10.5 mm 1.102 × .488 × .413 inch
Nominal operating power: 360 mW (single side stable type)
- **Sealed construction for automatic cleaning**
- **Latching types are also available**

SPECIFICATIONS

Contact

Arrangement	2 Form C	
Initial contact resistance, max. (By HP4328A)	100 mΩ	
Rating	Nominal switching capacity	0.01 A 24 V DC 10 W (at 1.2 GHz, Impedance 50Ω)
High frequency characteristics (Impedance 50Ω)	Isolation	Min. 40 dB (at 4 GHz)
	Insertion loss	Max. 1.0 dB (at 4 GHz)
	V.S.W.R.	Max. 1.5 (at 4 GHz)
Expected life (min. operations)	Mechanical	5×10 ⁶
	Electrical (at 20 cpm)	3×10 ⁵ (0.01 A 24 V DC) 1×10 ⁵ (10 W at 1.2 GHz, Impedance 50Ω)

Coil (at 25°C, 68°F)

	Nominal operating power
Single side stable	360 mW
1 coil latching	250 mW
2 coil latching	500 mW

Remarks

- * Specifications will vary with foreign standards certification ratings.
- *¹ Measurement at same location as "Initial breakdown voltage" section
- *² Detection current: 10mA
- *³ Excluding contact bounce time
- *⁴ Half-wave pulse of sine wave: 11ms, detection time: 10μs
- *⁵ Half-wave pulse of sine wave: 6ms
- *⁶ Detection time: 10μs

Characteristics

Max. operating speed (at rated load)	20 cpm	
Initial insulation resistance* ¹	Min. 100 MΩ at 500 V DC	
Initial breakdown voltage* ²	Between open contacts	500 Vrms for 1 min.
	Between contact and coil	1,000 Vrms for 1 min.
	Between contact and earth terminal	500 Vrms for 1 min.
Operate time [Set time]* ³ (at nominal voltage)	Approx. 6 ms [Approx. 3ms]	
Release time (without diode)[Reset time]* ³ (at nominal voltage)	Approx. 3 ms [Approx. 3ms]	
Temperature rise	Max. 60°C with nominal coil voltage across coil and at nominal switching capacity	
Shock resistance	Functional* ⁴	Min. 98 m/s ² {10 G}
	Destructive* ⁵	Min. 980 m/s ² {100 G}
Vibration resistance	Functional* ⁶	10 to 55 Hz at double amplitude of 1.5 mm
	Destructive	10 to 55 Hz at double amplitude of 2 mm
Conditions for operation, transport and storage (Not freezing and condensing at low temperature)	Ambient temp.	-40°C to 60°C -40°F to 140°F
	Humidity	5 to 85% R.H.
Unit weight	Approx. 7 g .247 oz	

TYPICAL APPLICATIONS ORDERING INFORMATION

- Measuring equipment (Attenuator circuits)
- Audio visual equipment
- Communication equipment

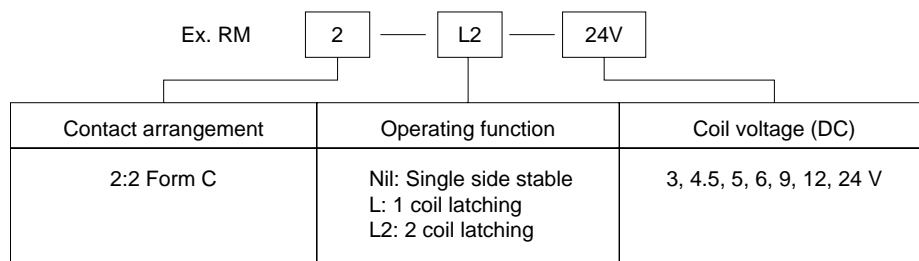

Note: Standard packing; Carton: 20 pcs. Case 200 pcs.

RM

TYPES ANE COIL DATA (at 20°C 68°F)

• Single side stable type

Part No.	Nominal voltage, V DC	Pick-up voltage, max. V DC	Drop-out voltage, min. V DC	Coil resistance, Ω ($\pm 10\%$)	Nominal operating current, mA	Nominal operating power, mW	Max. allowable voltage, V DC (at 60°C 140°F)
RM2-3V	3	2.25	0.3	25	120	360	3.3
RM2-4.5V	4.5	3.375	0.45	56	80	360	4.95
RM2-5V	5	3.75	0.5	69	72	360	5.5
RM2-6V	6	4.5	0.6	100	60	360	6.6
RM2-9V	9	6.75	0.9	225	40	360	9.9
RM2-12V	12	9	1.2	400	30	360	13.2
RM2-24V	24	18	2.4	1,600	15	360	26.4

• 1 coil latching type

Part No.	Nominal voltage, V DC	Set voltage, max. V DC	Reset voltage, max. V DC	Coil resistance, Ω ($\pm 10\%$)	Nominal operating current, mA ($\pm 10\%$)	Nominal operating power, mW	Max. allowable voltage, V DC (at 60°C 140°F)
RM2-L-3V	3	2.25	2.25	36	83.3	250	3.3
RM2-L-4.5V	4.5	3.375	3.375	81	55.6	250	4.95
RM2-L-5V	5	3.75	3.75	100	50	250	5.5
RM2-L-6V	6	4.5	4.5	144	41.7	250	6.6
RM2-L-9V	9	6.75	6.75	324	27.8	250	9.9
RM2-L-12V	12	9	9	576	20.8	250	13.2
RM2-L-24V	24	18	18	2,304	10.4	250	26.4

• 2 coil latching type

Part No.	Nominal voltage, V DC	Set voltage, max. V DC	Reset voltage, max. V DC	Coil resistance, Ω ($\pm 10\%$)		Nominal operating current, mA ($\pm 10\%$)		Nominal operating power, mW		Max. allowable voltage, V DC (at 60°C 140°F)
				Set coil	Reset coil	Set coil	Reset coil	Set coil	Reset coil	
RM2-L2-3V	3	2.25	2.25	18	18	166.7	166.7	500	500	3.3
RM2-L2-4.5V	4.5	3.375	3.375	40.5	40.5	111.1	111.1	500	500	4.95
RM2-L2-5V	5	3.75	3.75	50	50	100	100	500	500	5.5
RM2-L2-6V	6	4.5	4.5	72	72	83.3	83.3	500	500	6.6
RM2-L2-9V	9	6.75	6.75	162	162	55.6	55.6	500	500	9.9
RM2-L2-12V	12	9	9	288	288	41.7	41.7	500	500	13.2
RM2-L2-24V	24	18	18	1,152	1,152	20.8	20.8	500	500	26.4

DIMENSIONS

mm inch



Single side stable and 1 coil latching

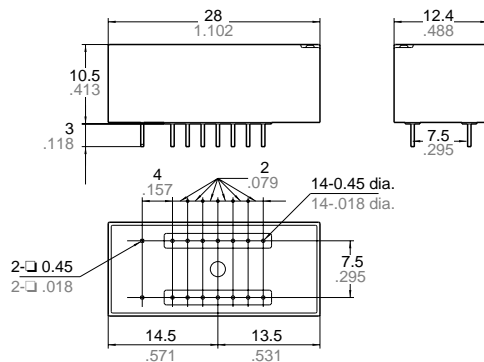

2 coil latching

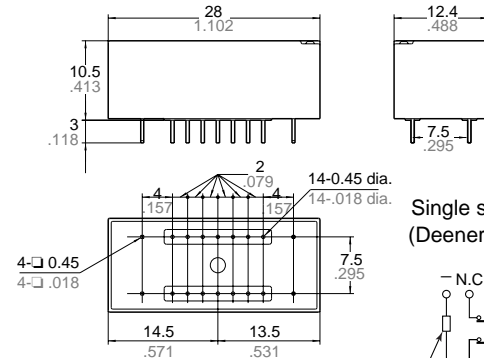

General tolerance: $\pm 0.3 \pm 0.12$

PC board pattern (Bottom view)

Single side stable and 1 coil latching

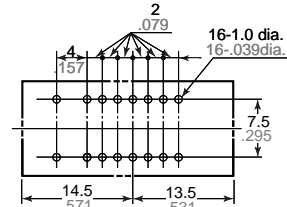

2 coil latching

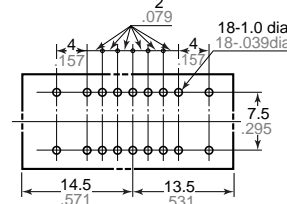

Tolerance: $\pm 0.3 \pm 0.12$

Schematic (Bottom view)

Single side stable (Deenergized condition)

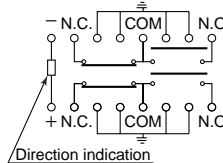

1 coil latching (Reset condition)

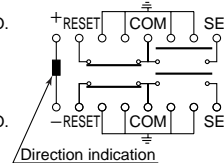

2 coil latching (Reset condition)

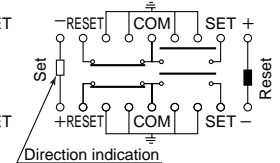

REFERENCE DATA

1. High frequency characteristics
 Sample: RM2-12V
 Measuring method: Impedance 50 Ω

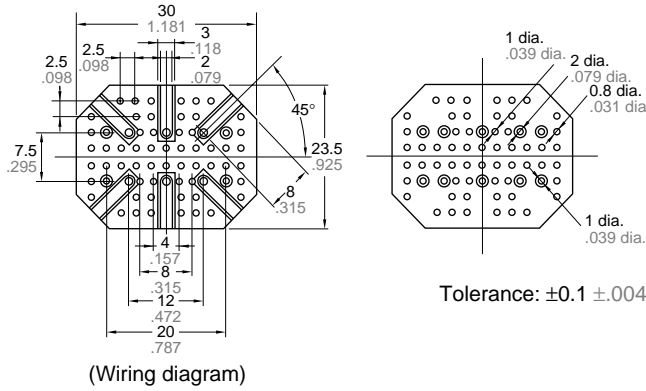

mm inch

PC board
 • Double-sided through hole
 • Material: Glass-PTFE

Tolerance: $\pm 0.1 \pm 0.004$

(Wiring diagram)

• Isolation

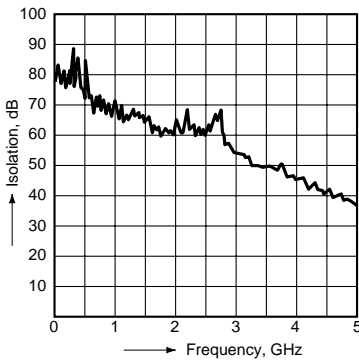

• Insertion loss

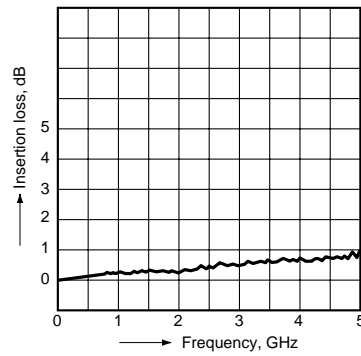

• V.S.W.R.

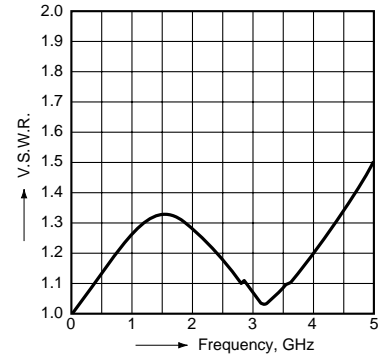

2. Coil temperature rise

Sample: RM2-12V; No. of samples: n = 5
 Carrying current: 10 mA
 Point measured: Inside the coil
 Ambient temperature: 27 to 28°C 80.6 to 82.4°F

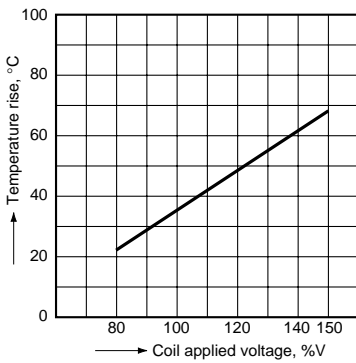

3.-(1) Operate/Release time

(Single side stable)
 Sample: RM2-12V; No. of samples: n = 6

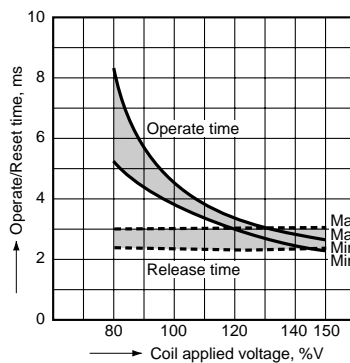

3.-(2) Set/Reset time (Latching)

Sample: RM2-L2-5V
 No. of samples: n = 5

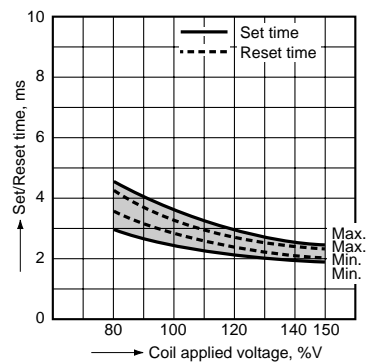

4. Mechanical life test

Sample: RM2-12V; No. of samples: n = 10

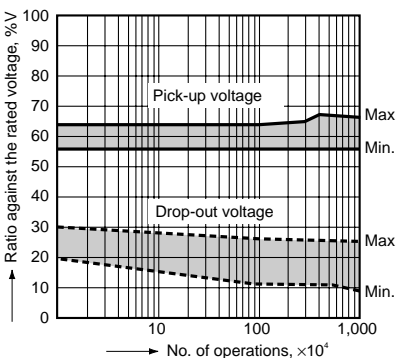

5. Electrical life test (0.01 A 24 V DC)

Sample: RM2-5V; No. of samples: n = 6
 Change of pick-up and drop-out voltage

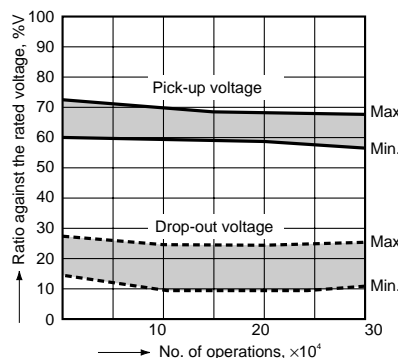

Change of contact resistance

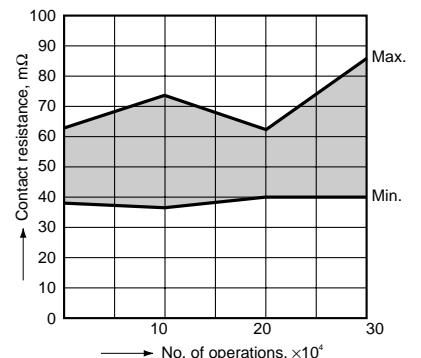

RM

6. Ambient temperature characteristics

Sample: RM2-12V; No. of samples: n = 5

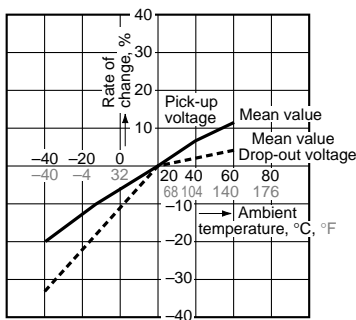

7. Contact resistance distribution (initial)

Sample: RM2-12V

No. of samples: n = 50 (50 × 4 contacts)

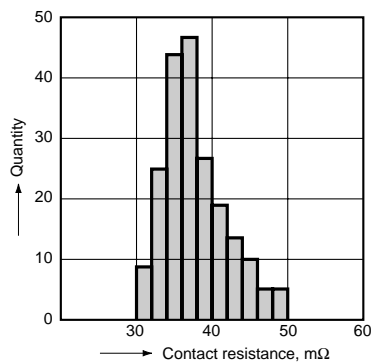

8.-(1) Influence of adjacent mounting

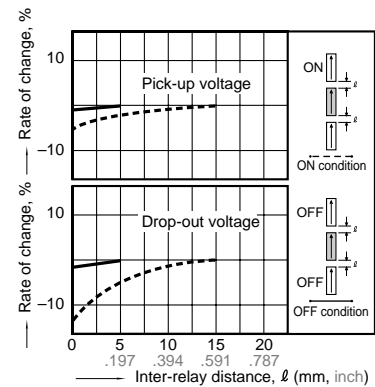

8.-(2) Influence of adjacent mounting

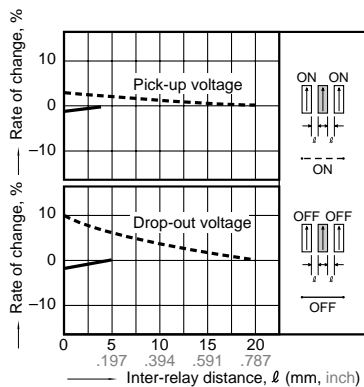

NOTE

1. Soldering

Soldering should be done under the following conditions.

Temperature	260°C 500°F	350°C 662°F
Time	Within 10 s	Within 3 s

For Cautions for Use, see Relay Technical Information (Page 48 to 76).