

TFT COLOR LCD MODULE

NL10276AC28-01L

**36 cm (14.1 inches), 1024 × 768 pixels, Full-color,
Multi-scan function, Built-in CRT interface board**

DESCRIPTION

NL10276AC28-01L is a TFT (thin film transistor) active matrix color liquid crystal display (LCD) comprising amorphous silicon TFT attached to each signal electrode, a driving circuit, a CRT interface board and a backlight. NL10276AC28-01L has a built-in backlight with an inverter.

The 36 cm (14.1 inches) diagonal display area contains 1024 × 768 pixels and can display full-color (more than 16 million colors simultaneously). Also, it has wide viewing angle and multi-scan function.

FEATURES

- High Luminance (200 cd/m². typ.)
- Low reflection
- CRT interface board
- Auto recognition of input signal:
 - Analog RGB signals, Synchronous signals (Hsync, Vsyn, Composite)
 - Digital control: e.g. Brightness, Display Position
 - Free supply voltage sequence
 - Corresponding to DDC1 and DDC2B
 - Corresponding to VESA DPMS
- Multi-scan function: e.g. XGA, SVGA, VGA, VGA-TEXT, MAC
- Incorporated edge type backlight (Two lamps into two lamp holders, Inverter)
- Lamp unit replaceable
 - (note)
 - VESA : Video Electronics Standards Association
 - DPMS : Display Power Management Signaling
 - DDC1 : Display Data Channel 1
 - DDC2B: Display Data Channel 2B

APPLICATIONS

- Desk-top type of PC
- Engineering workstation
- Display terminals for control system
- Monitors for process controller

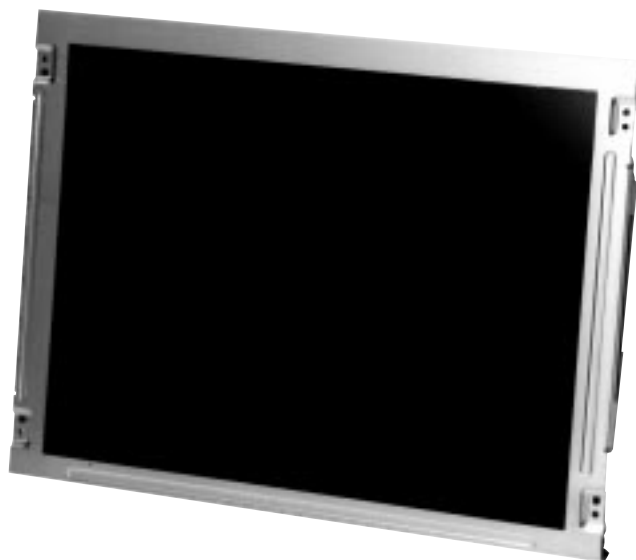

On Screen Display

Application with the OSD function might conflict with patents in Europe and/or the U.S.A.
If you apply the OSD function, appreciate the patents at your side.

The information in this document is subject to change without notice.
Please confirm with the delivery specification before starting to design the system.

STRUCTURE AND FUNCTIONS

A color TFT (thin film transistor) LCD module is comprised of a TFT liquid crystal panel structure, LSIs for driving the TFT array, and a backlight assembly. The TFT panel structure is created by sandwiching liquid crystal material in the narrow gap between a TFT array glass substrate and a color filter glass substrate. After the driver LSIs are connected to the panel, the backlight assembly is attached to the backside of the panel.

RGB (red, green, blue) data signals from a source system is modulated into a form suitable for active matrix addressing by the onboard signal processor and sent to the driver LSIs which in turn addresses the individual TFT cells.

Acting as an electro-optical switch, each TFT cell regulates light transmission from the backlight assembly when activated by the data source. By regulating the amount of light passing through the array of red, green, and blue dots, color images are created with clarity.

OUTLINE OF CHARACTERISTICS (at room temperature)

Items	Description
Display area	285.696 (H) × 214.272 (V) mm
Drive system	a-Si TFT active matrix
Display colors	Full-color
Number of pixels	1024 (H) × 768 (V)
Pixel arrangement	RGB vertical stripe
Pixel pitch	0.279 (H) × 0.279 (V) mm
Module size	330.0 (H) × 255.0 (V) × 19.8 (D) mm (typ.)
Weight	1230 g (typ.)
Contrast ratio	150:1 (typ.)
Viewing angle (more than the contrast ratio of 10:1)	<ul style="list-style-type: none"> • Horizontal : 50° (typ., left side, right side) • Vertical : 20° (typ., up side), 35° (typ., down side)
Designed viewing direction	<ul style="list-style-type: none"> • Optimum grayscale ($\gamma = 2.2$): perpendicular • Wider viewing angle with contrast ratio: down side (6 o'clock) • Wider viewing angle without image reversal: up side (12 o'clock)
Color gamut	40% (typ., At center, To NTSC)
Response time	11 ms (typ.), "white 100%" to "black 10%"
Luminance	200 cd/m ² (typ.)
Input signals	Analog RGB signals, Synchronous signals (Hsync and Vsync or Composite)
Backlight	Edge light type: two cold cathode fluorescent lamps with an inverter Lamp holder: 141LHS08 Inverter: 141PW111
Supply voltage	12 V, 12 V (Logic/LCD driving, Backlight)
Power consumption	16.0 W (typ.)

BLOCK DIAGRAM OF BASIC STRUCTURE

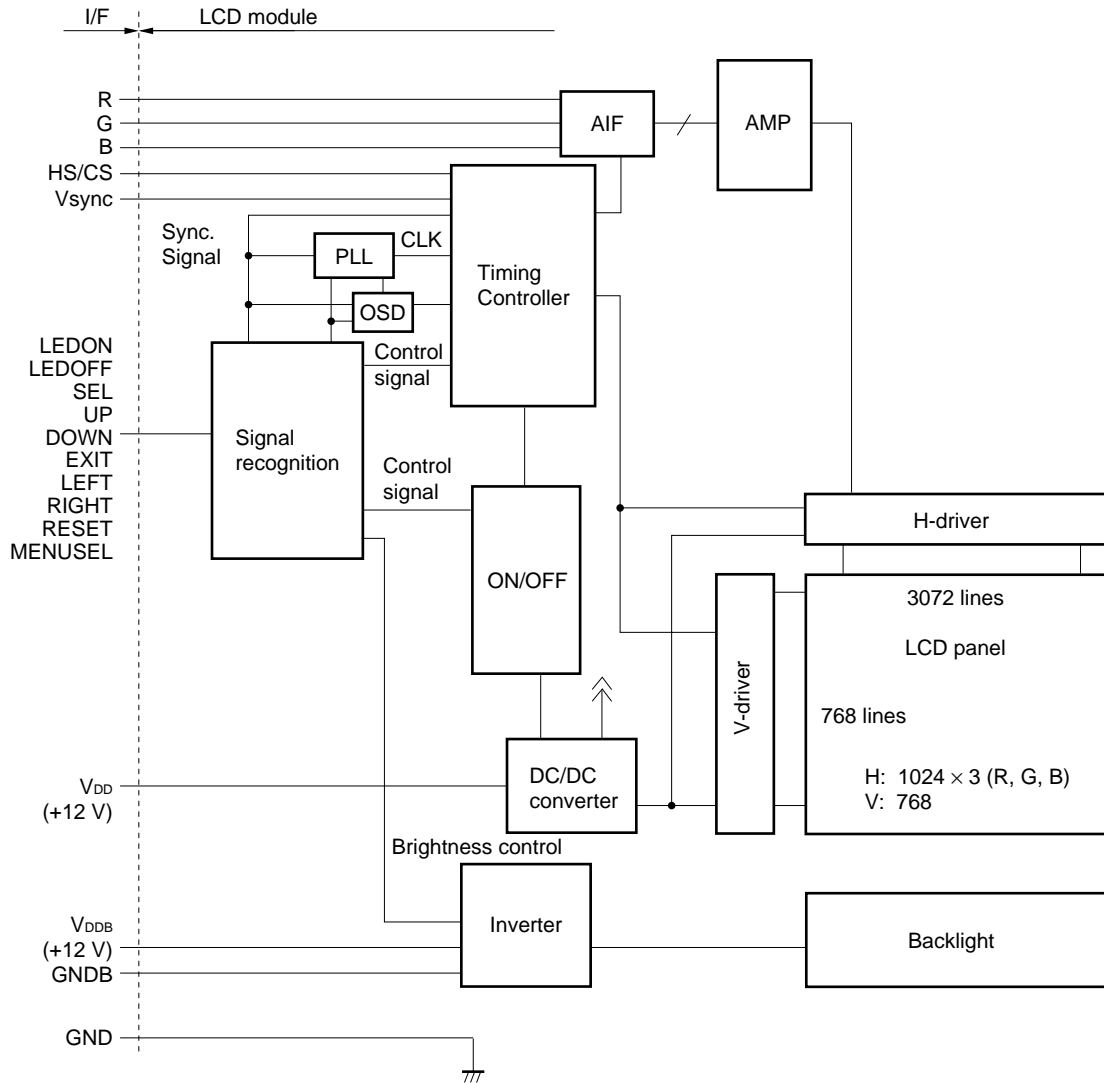

HS : Hsync
 CS : Composite synchronous signal

Note: Neither GND nor GNDB is connected to frame. These should be connected in customers' equipment.

GENERAL SPECIFICATIONS

Item	Description	Unit
Module size	330 ± 0.5 (H) × 255.0 ± 0.5 (V) × 20.5 (max.) (D)	mm
Display area	285.696 (H) × 214.272 (V)	mm
Number of dots	1024 × 3 (H) × 768 (V)	dots
Pixel pitch	0.279 (H) × 0.279 (V)	mm
Dot pitch	0.093 (H) × 0.279 (V)	mm
Pixel arrangement	RGB (Red, Green, Blue) vertical stripe	–
Display colors	Full color	color
Weight	1,350 (max.)	g

ABSOLUTE MAXIMUM RATINGS

Parameter	Symbol	Rating	Unit	Remarks	
Supply voltage	V _{DD}	–0.3 to + 14	V	T _a = 25°C	
	V _{DDB}	–0.3 to + 14	V		
Logic input voltage	V _{In1}	–0.3 to + 5.5	V	T _a = 25°C V _{DD} = 12 V	
R,G,B input voltage	V _{In2}	–6.0 to + 6.0	V		
Storage temp.	T _{st}	–20 to + 60	°C	–	
Operating temp.	T _{op}	0 to 50	°C	Module surface	Note
Relative Humidity		≤ 95%	%	T _a ≤ 40°C	No condensation
		≤ 85%		40 < T _a ≤ 50°C	
Absolute humidity	Absolute humidity shall not exceed T _a = 50°C, RH = 85 %		g/m ³	T _a > 50°C	

Note: Measured at the LCD panel (Including self-fever)

ELECTRICAL CHARACTERISTICS

(1) Logic, LCD driving, Backlight

(T_a = 25°C)

Item	Symbol	Min.	Typ.	Max.	Unit	Remarks
Supply voltage	V _{DD}	11.4	12.0	12.6	V	Logic and LCD driving
	V _{DDB}	11.4	12.0	12.6	V	Backlight
Logic input "L" voltage	V _{IL}	0	–	0.8	V	HS/CS, Vsync, UP, DOWN, SEL, RESET, EXIT, RIGHT, LEFT, DDCCLK, DDCDAT
Logic input "H" voltage	V _{IH}	2.2	–	5.25	V	
Logic output "L" voltage	V _{OL}	–	–	0.4	V	DDCDAT
Logic output "H" voltage	V _{OH}	2.4	–	–	V	
Logic input "L" current	I _{IL}	–1	–	–	μA	HS/CS, Vsync
Logic input "H" current	I _{IH}	–	–	1	μA	
Logic output "L" current 1	I _{OL1}	–	–	100	μA	DDCDAT
Logic output "H" current 1	I _{OH1}	–100	–	–	μA	
Supply current (Pixel checked pattern)	I _{DD}	–	630	900	mA	V _{DD} = 12.0 V
		–	170	200	mA	Power saving mode V _{DD} = 12.0 V
	I _{DDB}	–	700	900	mA	V _{DDB} = 12.0 V (Max. luminance)
		–	0.3	10	mA	Power saving mode V _{DDB} = 12.0 V

(2) Video signal (R, G, B) input

(T_a = 25°C)

Items	Min.	Typ.	Max.	Unit	Remarks
Maximum amplitude (white - black)	0 (black)	0.7 (white)	*A	V _{p-p}	Note
DC input level (black)	–0.5	–	+2.5	V	–
Sync level	–0.2	0.3	*B (0.6)	V _{p-p}	G terminal (sync on green)
*A + *B	–	–	1.4	V _{p-p}	–

Note: Contrast adjustment is needed if the amplitude exceeds 0.7 V_{p-p}.

Supply Voltage Sequence

- (1) Please note that the supply voltage must not be applied to the module while the control signals (SEL, UP, DOWN, EXIT, LEFT, RIGHT and RESET) are connected to GND. Otherwise the module may cause malfunction.
- (2) If the power supply voltage is applied while UP and DOWN are connected to GND, the input control signals become an ineffective mode. To reset this mode, turn off the power once and turn on the power while UP and DOWN are connected to GND. Then, the mode will be released.
- (3) Do not change MENUSEL setting while the module is operated.
MENUSEL selection (Hierarchical type or Toggle type) is set when the power supply voltage is applied.
- (4) Inverter current wave
Inverter current wave is as follows.

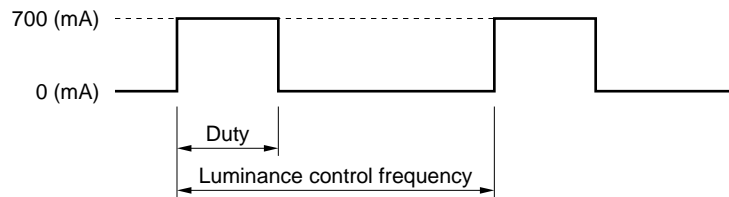

maximum luminance control: 100 % (Duty)
 minimum luminance control: 20 % (Duty)
 Luminance control frequency = Input Vsync frequency × K
 Input Vsync frequency ≤ 75 Hz: K = 4.6
 Input Vsync frequency > 75 Hz: K = 3.6

- (5) Ripple of supply voltage
Please note that the ripple at the input connector of the module should be within the values shown in this table. If the ripple is beyond these values, the noise may appear on the screen.

Supply voltage	V _{DD} (for logic and LCD driver)	V _{DDB} (for backlight)
Acceptable range	≤ 100 mVp-p	≤ 200 mVp-p

Note: The acceptable range of ripple voltage includes spike noise.

Example of the power supply connection

a) Separate the power supply

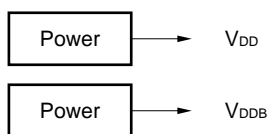

b) Put the filter

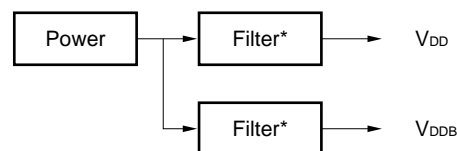

Filter* (reference value)
 L = 10 μH to 100 μH
 C = 10 μF to 100 μF

INTERFACE AND CONNECTOR PIN ASSIGNMENT

(1) Logic and LCD driving

CN1

Part No. : 1-353119-4

Adaptable socket : 1-353068-4

Supplier : Japan AMP Ltd.

Pin No.	Symbols	Pin No.	Symbols
1	B	8	Vsync
2	GND	9	GND
3	G	10	HS/CS
4	GND	11	GND
5	R	12	DDCCLK
6	GND	13	N.C.
7	GND	14▼	DDCDAT

Figure from socket view

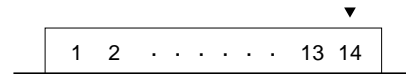

Note 1: N.C. (No connection) must be open.

CN3

Part No. : DF14A-25P-1.25H

Adaptable socket : DF14-25S-1.25C

Supplier : HIROSE ELECTRIC CO., LTD.

Pin No.	Symbols	Pin No.	Symbols
1▼	LEDON	14	EXIT
2	LEDOFF	15	GND
3	GND	16	N.C.
4	N.C.	17	GND
5	N.C.	18	GND
6	RIGHT	19	MENUSEL
7	LEFT	20	N.C.
8	RESET	21	N.C.
9	N.C.	22	N.C.
10	GND	23	GND
11	SEL	24	N.C.
12	UP	25	N.C.
13	DOWN		

Figure from socket view

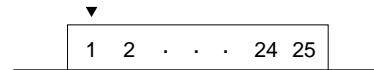

Note 1: N.C. (No connection) must be open.

CN5

Part No. : IL-Z-8PL-SMTY

Adaptable socket : IL-Z-8S-S125C3

Supplier : Japan Aviation Electronics Industry Limited (JAE)

Pin No.	Symbols	Pin No.	Symbols
1	V _{DD}	5	GND
2	V _{DD}	6	GND
3	V _{DD}	7	GND
4	V _{DD}	8▼	GND

Figure from socket view

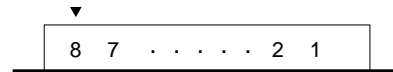

(2) Backlight

CN201

Part No. : IL-Z-11PL1-SMTY

Adaptable socket : IL-Z-11S-S125C3

Supplier : Japan Aviation Electronics Industry Limited (JAE)

Pin No.	Symbols	Pin No.	Symbols
1	V _{DDB}	7	N.C.
2	V _{DDB}	8	N.C.
3	V _{DDB}	9	N.C.
4	GNDB	10	N.C.
5	GNDB	11▼	N.C.
6	GNDB		

Figure from socket view

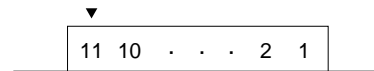

Note 1: N.C. (No connection) must be open.

Rear view

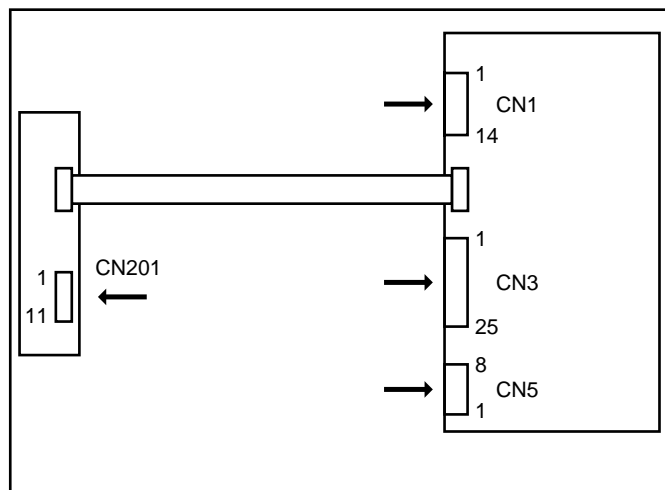

(3) PIN FUNCTION

Symbol	I/O	Logic	Description
HS/CS	Input	Negative	Horizontal synchronous signal input or composite synchronous signal input (TTL level), Positive/Negative auto recognition
Vsync	Input	Negative	Vertical synchronous signal input (TTL level) Positive/Negative auto recognition, Clock input for DDC1
R	Input	–	Red video signal input (0.7 Vp-p, input impedance 75 Ω)
G	Input	–	Green video signal input (0.7 Vp-p, input impedance 75 Ω)
B	Input	–	Blue video signal input (0.7 Vp-p, input impedance 75 Ω)
LEDON	Output	Positive	Indicator for LED power on “H”: LED select, “L”: Other status
LEDOFF	Output	Positive	Indicator for power save mode “H”: Power mode select, “L”: Other status
DDCCLK	Input	Positive	CLK for DDC2B
DDCDAT	Input/ Output	Positive	Data for DDC1/2B read/write
SEL	Input	Negative	Control function select signal (TTL level) SEL is pulled up in the module. Detail of the functions are mentioned in Page 13 CONTROL FUNCTIONS . “H” or “open”: SEL off, “L”: SEL on
UP	Input	Negative	Control signal (TTL level) The signal increases the value of the functions selected. UP is pulled up in the module. “H” or “open”: UP off, “L”: UP on
DOWN	Input	Negative	Control signal (TTL level) The signal decreases the value of the functions selected. DOWN is pulled up in the module. “H” or “open”: DOWN off, “L”: DOWN on
EXIT	Input	Negative	Control function exit signal (TTL level) EXIT is pulled up in the module. “H” or “open”: EXIT off, “L”: EXIT on
RIGHT Note1	Input	Negative	Control signal (TTL level) The signal increases the value of the functions selected. RIGHT is pulled up in the module. “H” or “open”: RIGHT off, “L”: RIGHT on
LEFT Note1	Input	Negative	Control signal (TTL level) The signal decreases the value of the functions selected. LEFT is pulled up in the module. “H” or “open”: LEFT off, “L”: LEFT on
RESET Note1	Input	Negative	Control signal (TTL level) The signal initializes the selected function. RESET is pulled up in the module. “H” or “open”: RESET off, “L”: RESET on
MENUSEL	Input	–	OSD design select signal (TTL level) MENUSEL is pulled up in the module. “H or open”: Hierarchical type “L”: Toggle type For detail, see Page 10 OSD MENU SELECT .

Symbol	I/O	Logic	Description
V _{DD}	–	–	Power supply for Logic and LCD driving +12 V (±5%)
V _{DDB}	–	–	Power supply for backlight +12 V (±5%)
GND	–	–	Ground for system
GNDB	–	–	Ground for backlight

Notes 1: This terminal becomes effective only when the value of Button Sel is 7.

Detail of the functions is mentioned in Page 27 **INITIAL VALUE CHANGE FUNCTIONS**.

2: Ground for system (GND) and backlight (GNDB) are not connected in the module.

3: 12 V for backlight should be started up within 300 ms, otherwise, the protection circuit makes the backlight turn off.

(4) OSD MENU SELECT

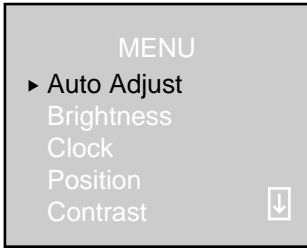
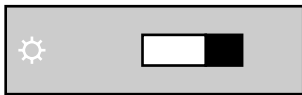
OSD menu type	Hierarchical type	Toggle type
MENUSEL	“H” or “open”	“L”
How to adjust	For details, see Page 27 INITIAL VALUE CHANGE FUNCTIONS . 	For details, see Page 27 INITIAL VALUE CHANGE FUNCTIONS . 

Notes 1: If OSD menu type is changed, the adjustment of the type becomes default value.

Then, It takes 5 seconds to display the changed menu after the supply voltage is input again.

And, Indicators for both LEDON and LEDOFF are “ON” at one time during the 5 seconds.

2: The Initial value of Contrast ratio is as follows.

Hierarchical type: 128:1 (typ.)

Toggle type: 100:1 (typ.)

3: On Screen Display

Application with the OSD function might conflict with patents in Europe and/or the U.S.A.

If you apply the OSD function, appreciate the patents at your side.

(5) Equivalent circuit

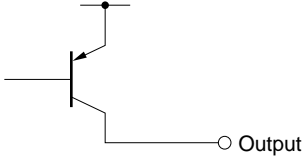
Symbol	I/O	Equivalent circuit
LEDON LEDOFF	Output	RN2306 (Toshiba) Or equivalent 

<Example of LED circuit>

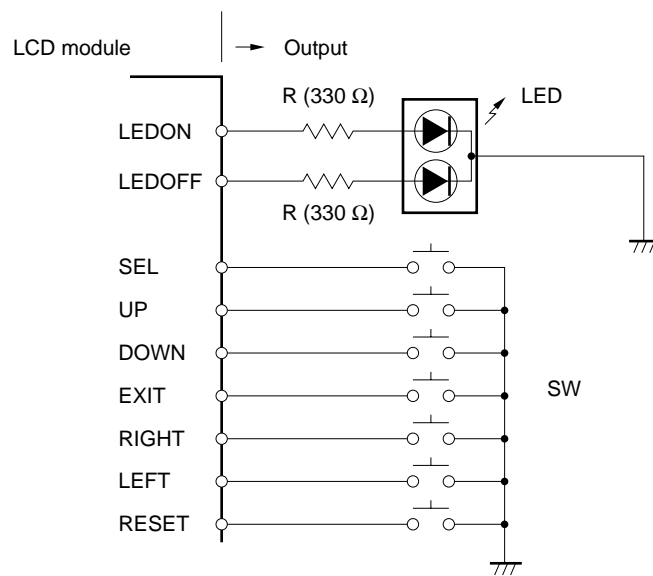

INPUT SIGNALS

(1) SYNCHRONOUS SIGNAL

This module is corresponding to the synchronous signals below.

Auto recognition mode	Synchronous signal		
	HS/CS	Vsync	Sync. On Green
Separate synchronous signal mode (HS, Vsync)	Input	Input	Input or no input
Composite synchronous mode	Input (cs)	No input	Input or no input
Sync. On Green mode	No input	No input	Input
Power saving mode	Input (HS)	No input	Input or No input
	No input	Input	Input or no input
	No Input	No input	No input

Notes 1: Power saving mode corresponds to VESA DPMA.

2: The module recognizes Sync on Green signal automatically, when the FUNC in SOG Sel of Sel Data is "Y". Refer to Page 27 **INITIAL VALUE CHANGE FUNCTION**.

(2) PRESET TIMING

The 14 types of display timing shown below are preset in this module. The input synchronous signals are automatically recognized.

Preset No.	Display size	Vsync (Hz)	Hsync (kHz)	SYSTEM CLK (MHz)	V Pulse (H)	V B.Porch (H)	H Pulse (CLK)	H B.Porch (CLK)	Sync Logic V, H	Remarks
1	640 × 400	56.432	24.830	21.053	8	25	96	48	-, -	*
2	640 × 480	59.992	31.469	25.175	2	33	96	48	-, -	VGA
3	720 × 400	70.087	31.469	28.322	2	35	108	45	+, -	VGA TXT
4	800 × 600	60.317	37.879	40.000	4	23	128	88	+, +	VESA
5	640 × 480	66.667	35.000	30.240	3	39	64	96	SonG	Macintosh
6	640 × 480	75.000	37.500	31.500	3	16	64	120	-, -	VESA
7	720 × 400	85.039	37.927	35.500	3	42	36	144	+, -	VESA
8	640 × 480	85.008	43.269	36.000	3	25	48	112	-, -	*
9	1024 × 768	60.004	48.363	65.000	6	29	136	160	-, -	VESA
10	800 × 600	75.000	46.875	49.500	3	21	80	160	+, +	VESA
11	832 × 624	74.565	49.735	57.283	3	39	64	224	SonG	Macintosh
12	800 × 600	85.061	53.674	56.250	3	27	64	152	+, +	*
13	1024 × 768	70.069	56.476	75.000	6	29	136	144	+, +	VESA
14	1024 × 768	75.029	60.023	78.750	3	28	96	176	+, +	VESA

* Out of specification.

- Notes 1:** Even if the preset timing is entered, a little adjustment of the functions such as Horizontal period, CLK-delay and display position, are required. The adjusted values are memorized in every preset No.
- 2:** This module recognizes the synchronous signals with near preset timing of the frequency of HS, Vsync, even in the case that the signals other than the preset timing were entered. For instance, the module shows the display with presetting number 6 in the case of the following conditions: 640 × 480 dot; HS: 37.861kHz; Vsync: 72.809 Hz. Please note that using out of the preset timings may cause wrong magnification ratio, unfitness of control functions or other improper displays.
- 3:** The display color scale may be different between Sync on Green Input and the others.

CONTROL FUNCTIONS

(1) EXPANSION MODES

Expansion mode is a function to expand the screen size in different resolutions. For example, VGA signal has 640 × 480 pixels. But, if the display data can be expanded to 1.6 times vertically and horizontally, VGA screen image can be displayed fully on the screen of XGA resolution.

This module automatically recognizes the timing shown in “PRESET TIMING” as an expansion mode.

Please adopt this mode after evaluating display quality, because the appearance in expansion mode may become bad in some cases.

The followings show display magnifications for each mode.

Input display	Number of pixels	Magnification	
		Vertical	Horizontal
XGA	1024 × 768	1.0	1.0
SVGA	800 × 600	1.25	1.25
VGA	640 × 480	1.6	1.6
VGA text	720 × 400	1.92 / 1.6 hierarchical / toggle	1.42
MAC	832 × 624	1.2	1.2

<DISPLAY IMAGE>

(a) SVGA mode (800 × 600)

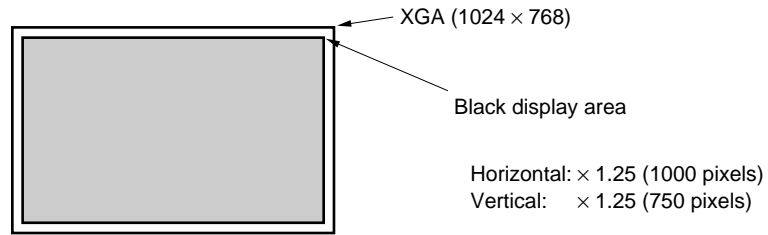

(b) VGA mode (640 × 480)

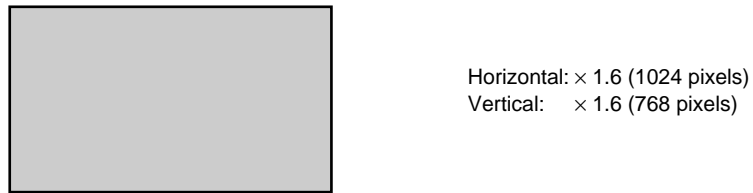

(c) VGA text mode (720 × 400)

(i) Hierarchical type

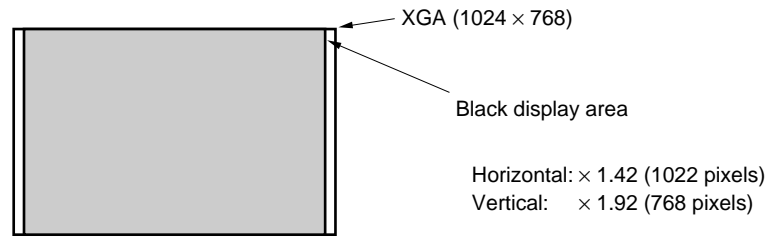

(ii) Hierarchical type

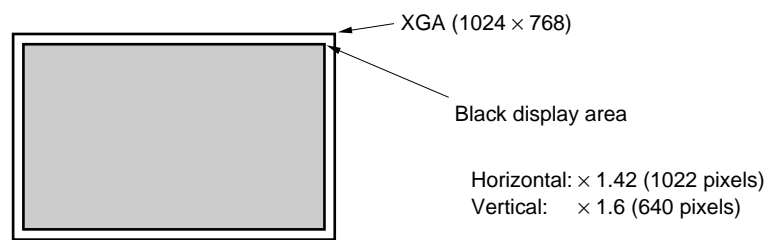

(d) 832 × 624 MAC mode (832 × 624)

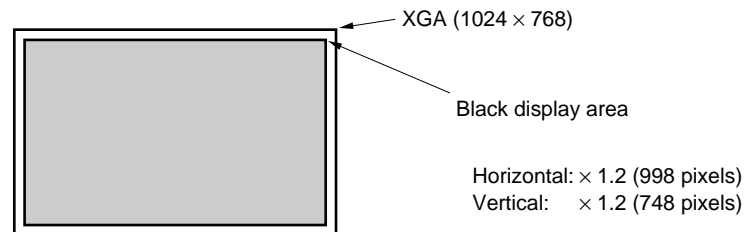

(2) DDC FUNCTION

This function is corresponding to VESA DDC™ and EDID™ (Structure Version 1).

Follow the specifications of the IC when you write data. Then VCLK should be fixed on “H.”

Please write a data into necessary addresses in advance when you use this function. Data “55H” in address “00H” and “FFH” in other address are already programmed when shipping. The input equivalent circuit diagram is as follow.

EDID: Extended Display Identification Data

<Internal circuit diagram>

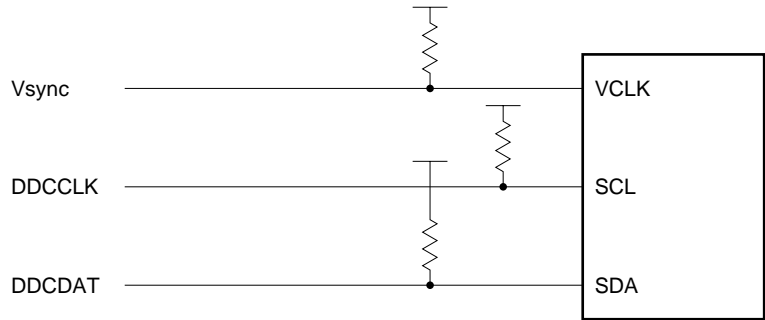

Product: Microchip Technology Inc.
24LCS21
or equivalent

(3) DPMS

This function is corresponding to VESA DPMS™ Standard.

VESA DPMS Standard						NL10276AC28-01L	
State	Signal			Power saving	Recovery time	Power saving	Recovery time
	Horizontal	Vertical	Video				
On	Pulses	Pulses	Active	None	Not applicable	None	Not applicable
Stand-by	No pulses	Pulses	Blanked	Minimum	Short	Maximum	Short
Suspend	Pulses	No pulses	Blanked	Substantial	Longer	Maximum	Short
Off	No pulses	No pulses	Blanked	Maximum	System dependent	Maximum	Short

(4) CONTROL FUNCTION ITEMS

No.	Form		Function items
1	Auto adjust		Clock and Position auto adjust
2	Brightness		Brightness of backlight control
3	Clock	H. Size	Horizontal display period adjust
		Clock Phase	CLK-phase adjust
4	Position	H. Position	Horizontal position adjust
		V. Position	Vertical position adjust
5	Contrast	W, R, G, B	White-level of video signals; synchronous color and each color are controllable.
		W	White-level of video signal synchronous color control
6	Color Level	W, R, G, B	Color-level of video signals; synchronous color and each color are controllable.
		W	Color-level of video signal synchronous color control
7	Information		Video signal information Display multi-scan function, Hsync and Vsync frequency
8	OSD Position		OSD position adjust The display position of OSD can be moved.
9	Config		Sync on Green signal. Response or non-response to Sync on Green signal is selected. When non-response is selected by Page 27 INITIAL VALUE CHANGE FUNCTIONS , config is not displayed.
10	All Reset		Reset to initial value. The values in No. 1 to No. 6, No. 8 and No. 9 are returned to the initial values.

In order to achieve the best picture quality, the above functions should be adjusted by setting SEL, UP, DOWN, LEFT, RIGHT, RESET and EXIT signals. Each adjusted value is memorized as soon as SEL is selected or time out mode is valid and the memorized values are not affected even if the power is switched off. But the selected value is not memorized in case where a selected mode is changed to another or the power is turned off before time out.

(5) FLOW CHART OF CONTROL FUNCTIONS

(a) Hierarchical type (4 switches used for adjustment; SEL; UP; DOWN; EXIT)

* For details, see Page 27 INITIAL VALUE CHANGE FUNCTIONS – 6. Sel Data, Button Sel -

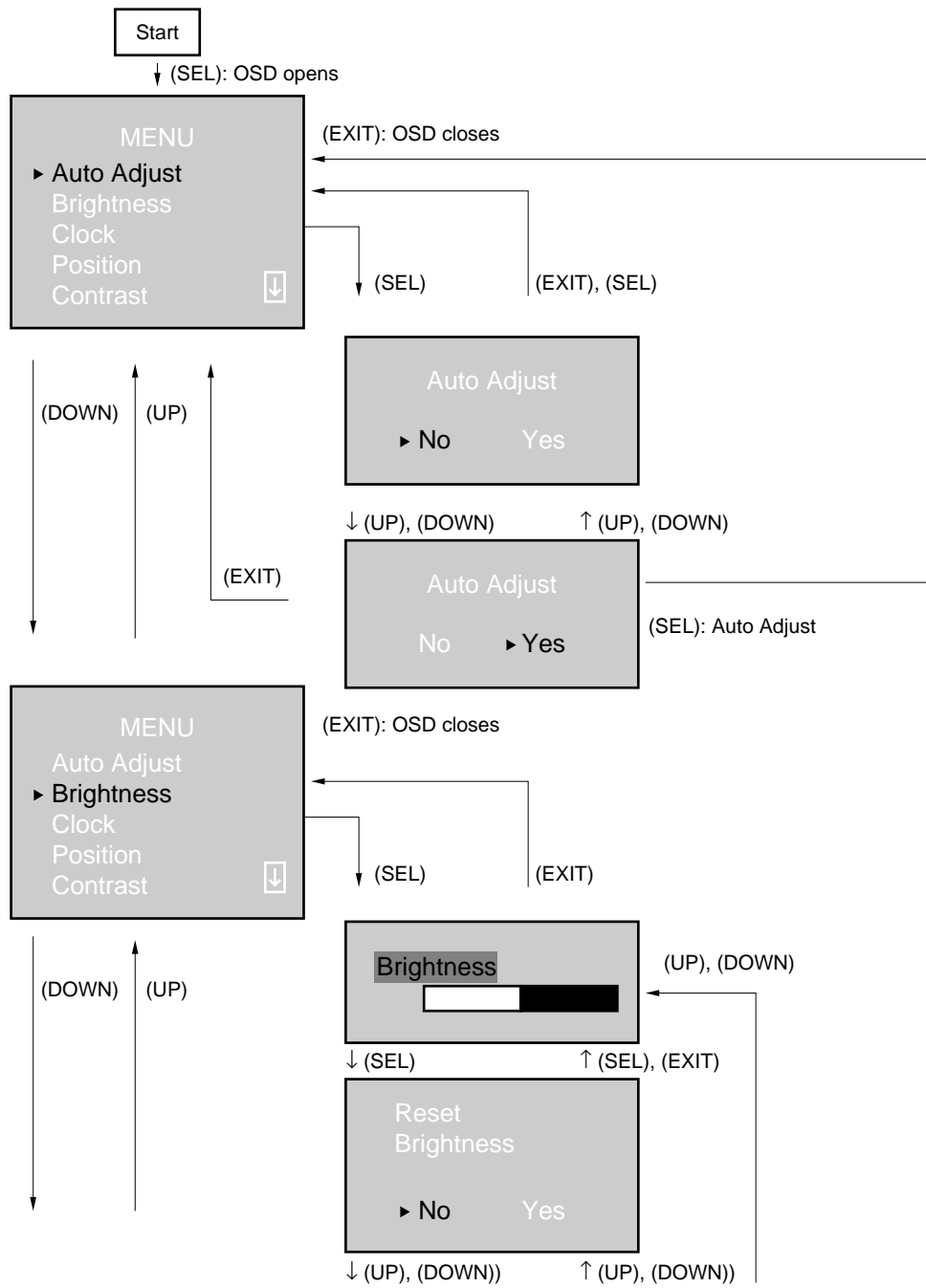

Continue to next page

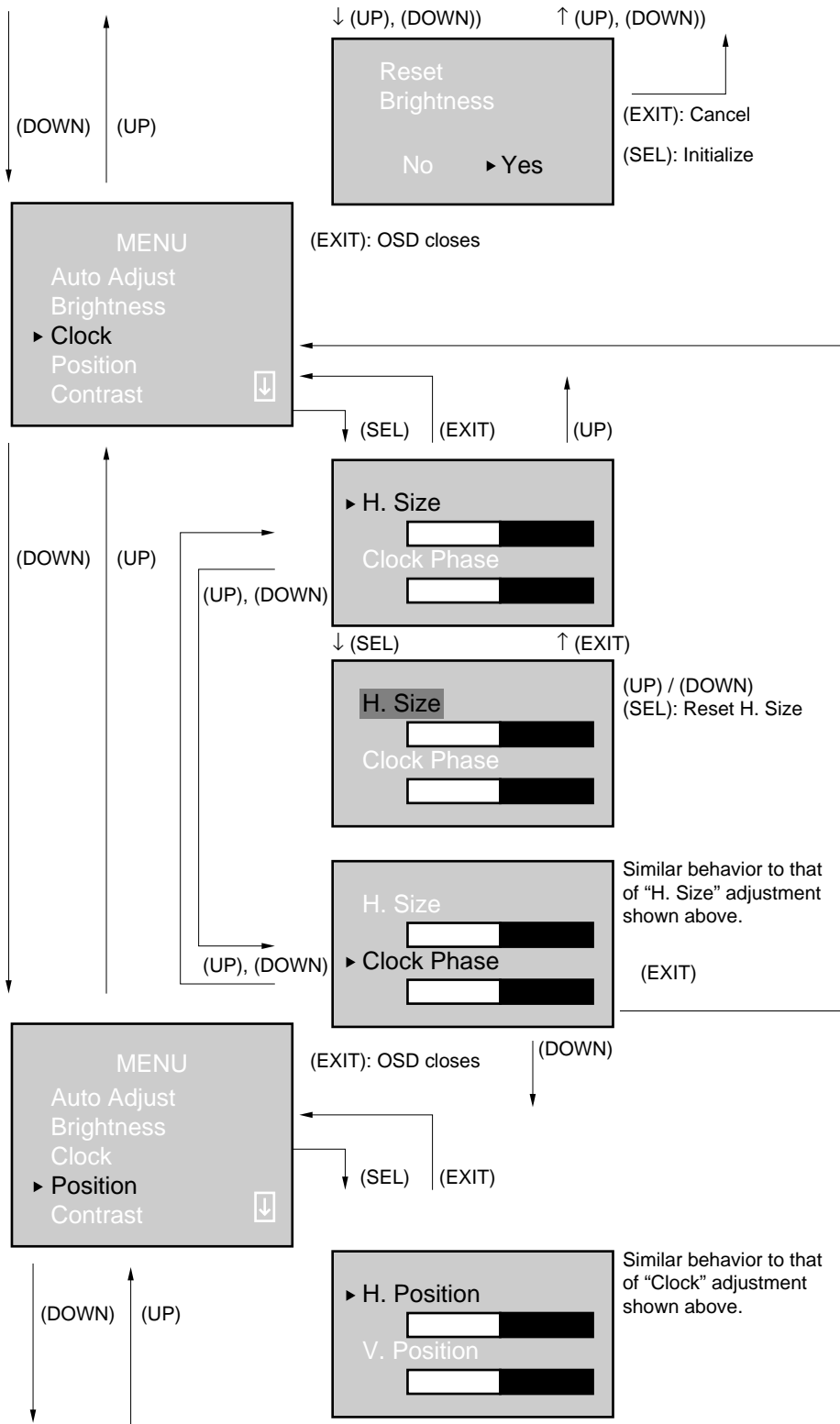

Continue to next page

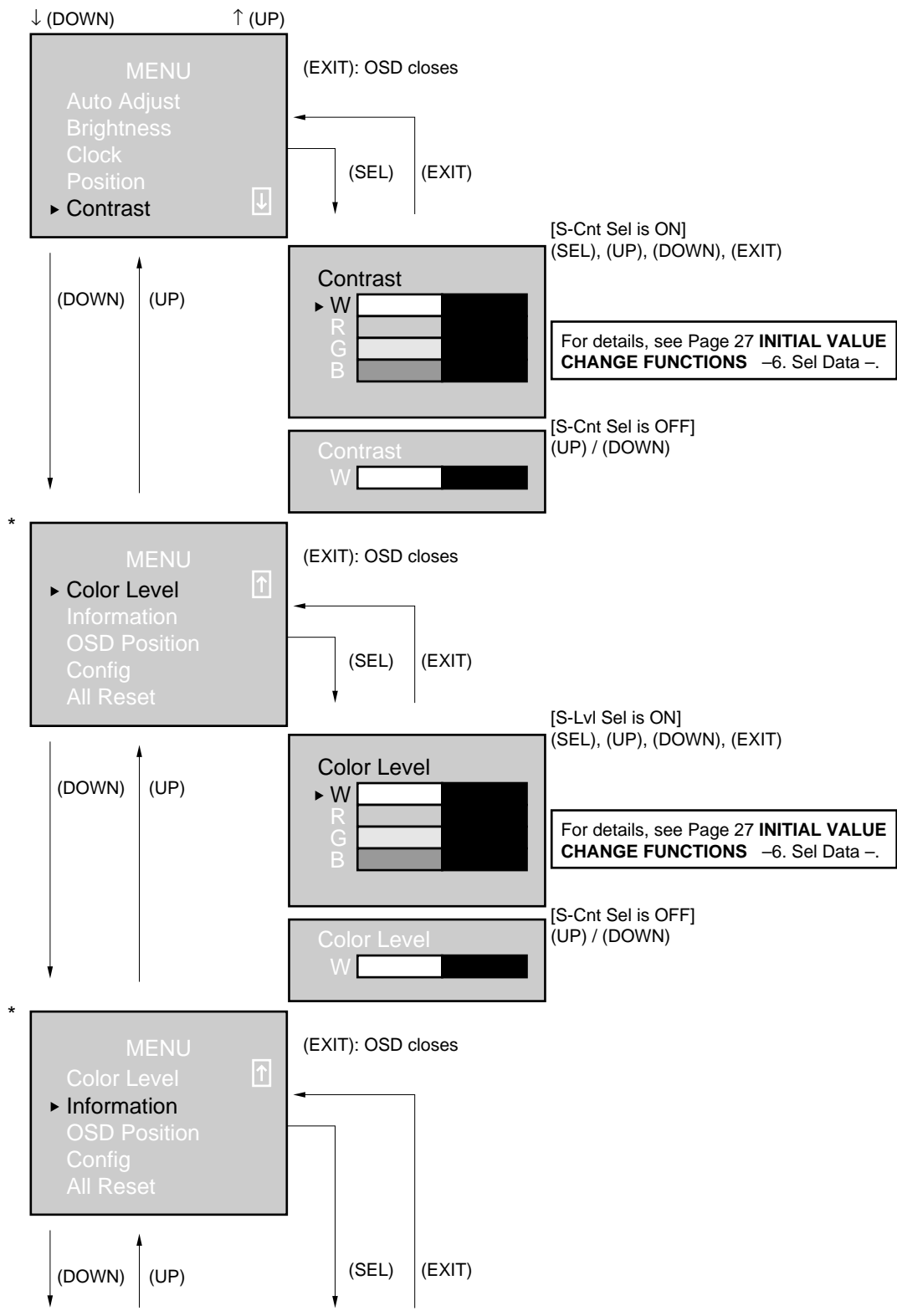

Continue to next page

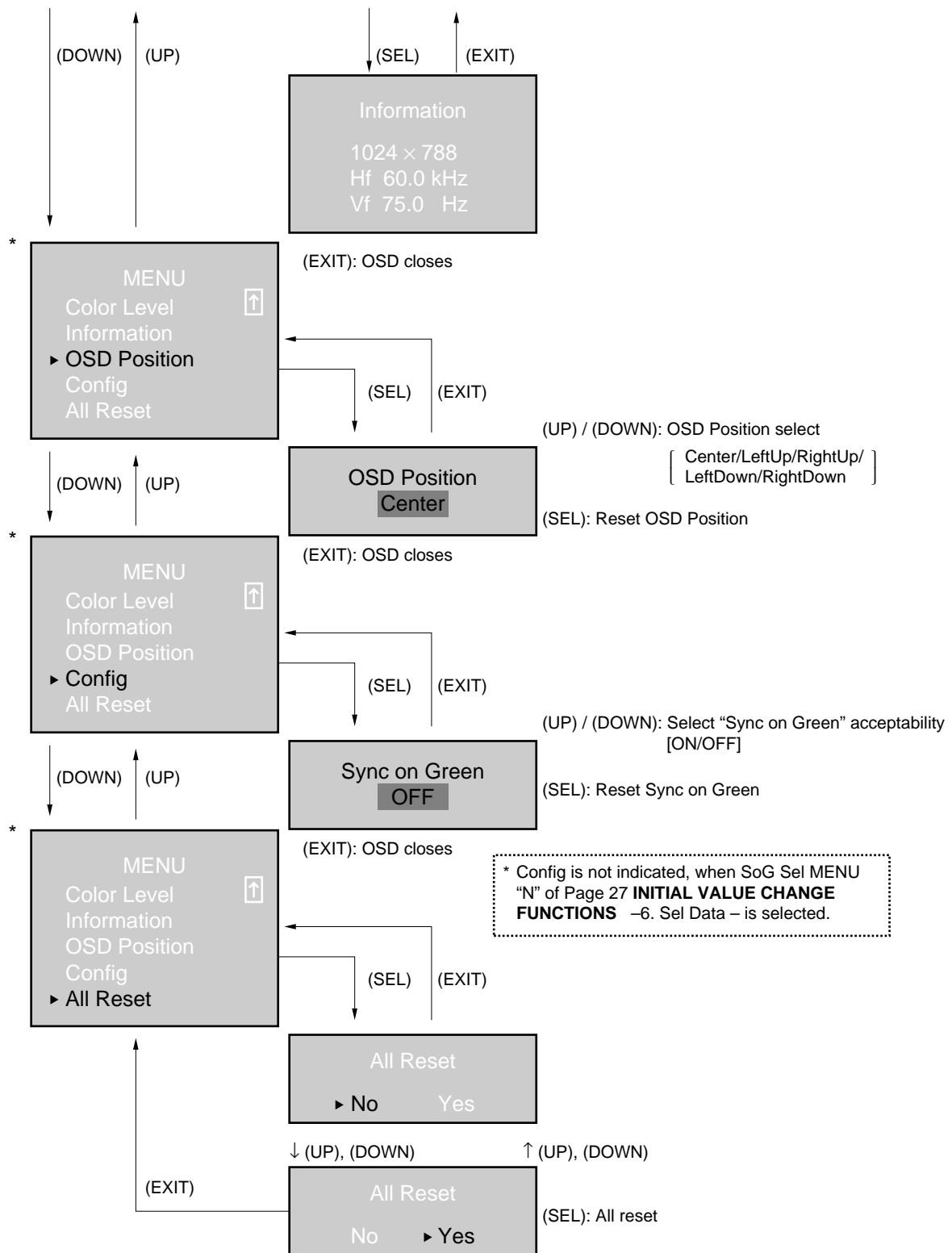

(b) Hierarchical type (7 switches used for adjustment: SEL; UP, DOWN; EXIT; LEFT; RIGHT; RESET)

* For details, see Page 27 **INITIAL VALUE CHANGE FUNCTIONS** – 6. Sel Data, Button Sel -.

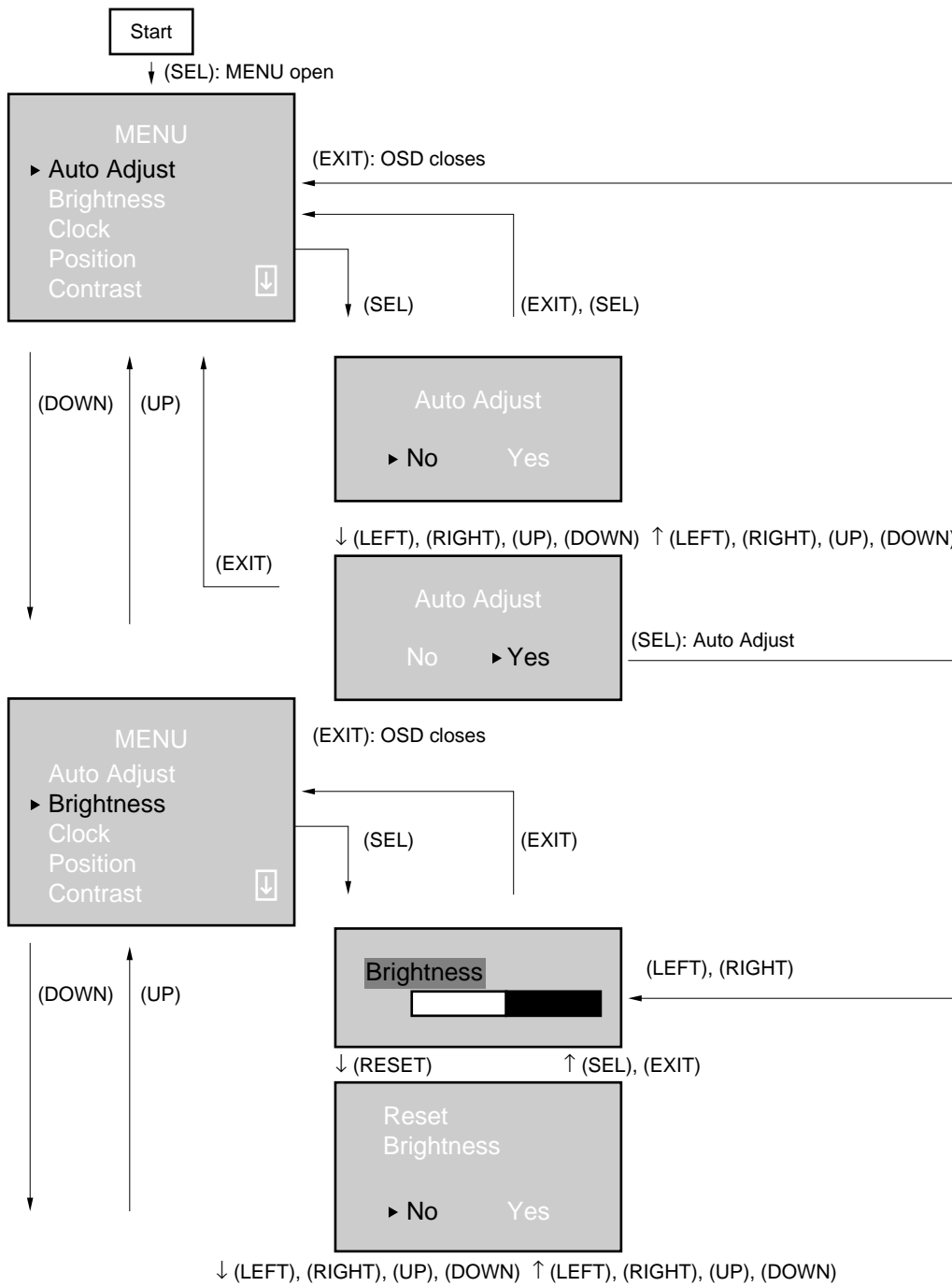

Continue to next page

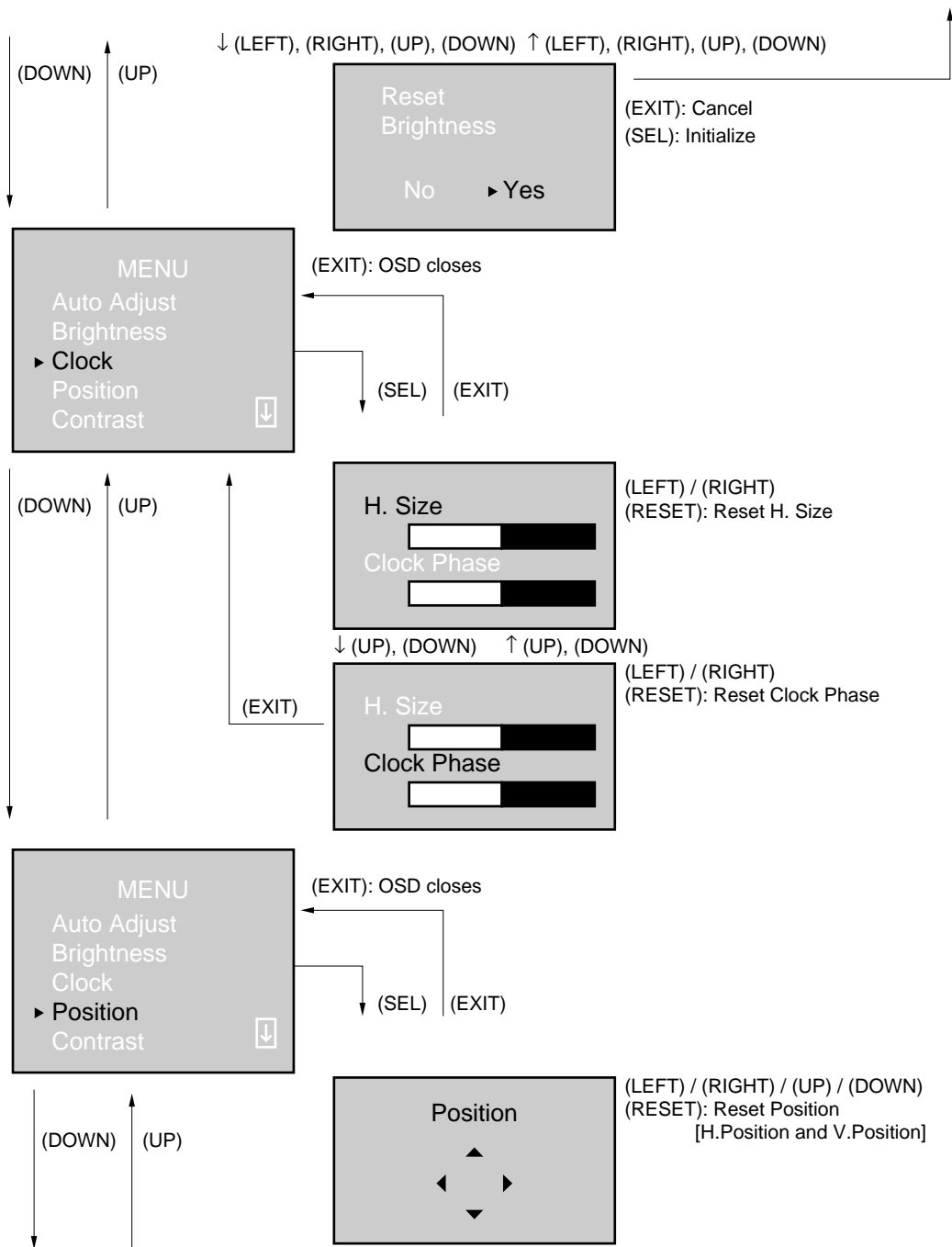

Continue to next page

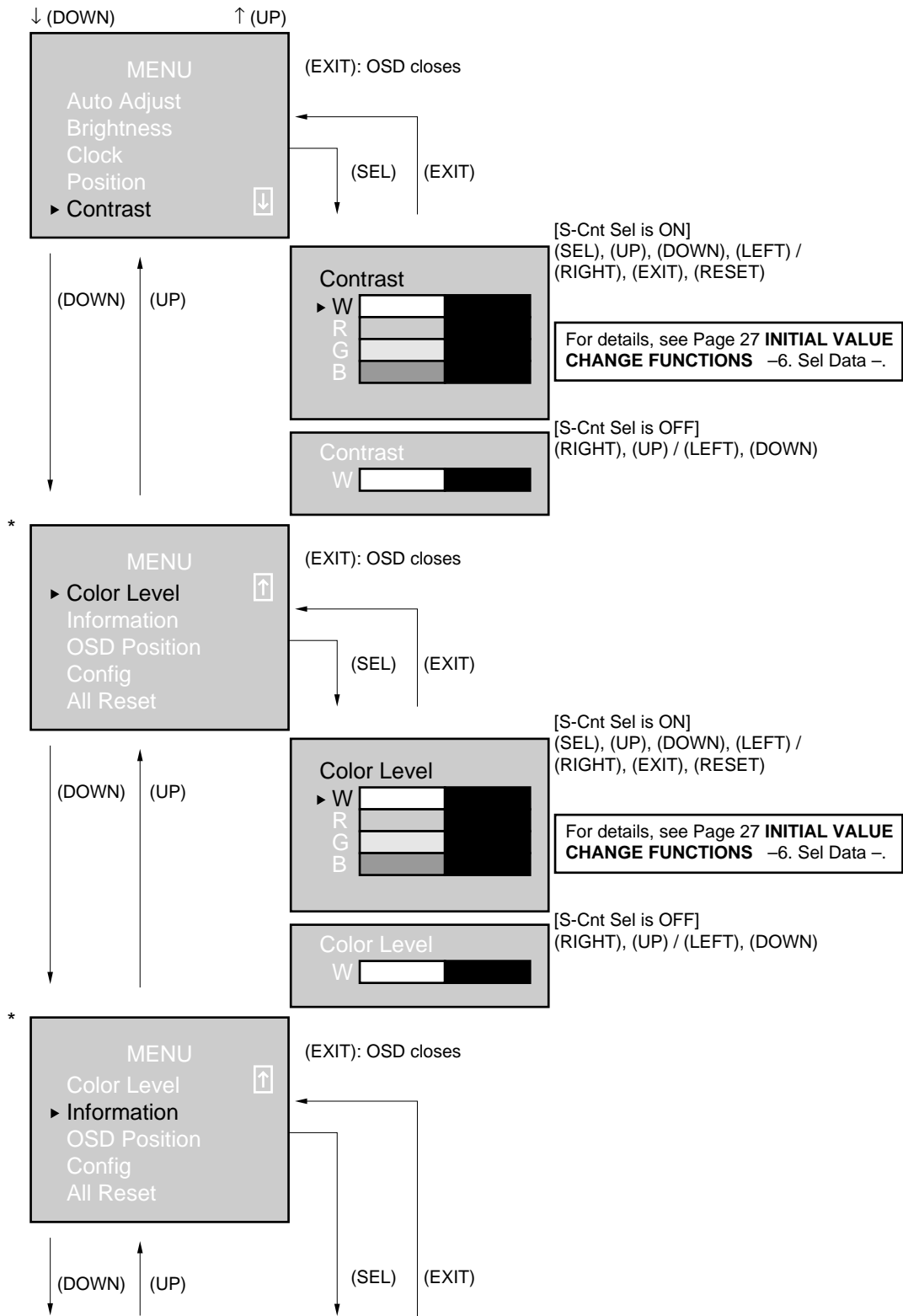

Continue to next page

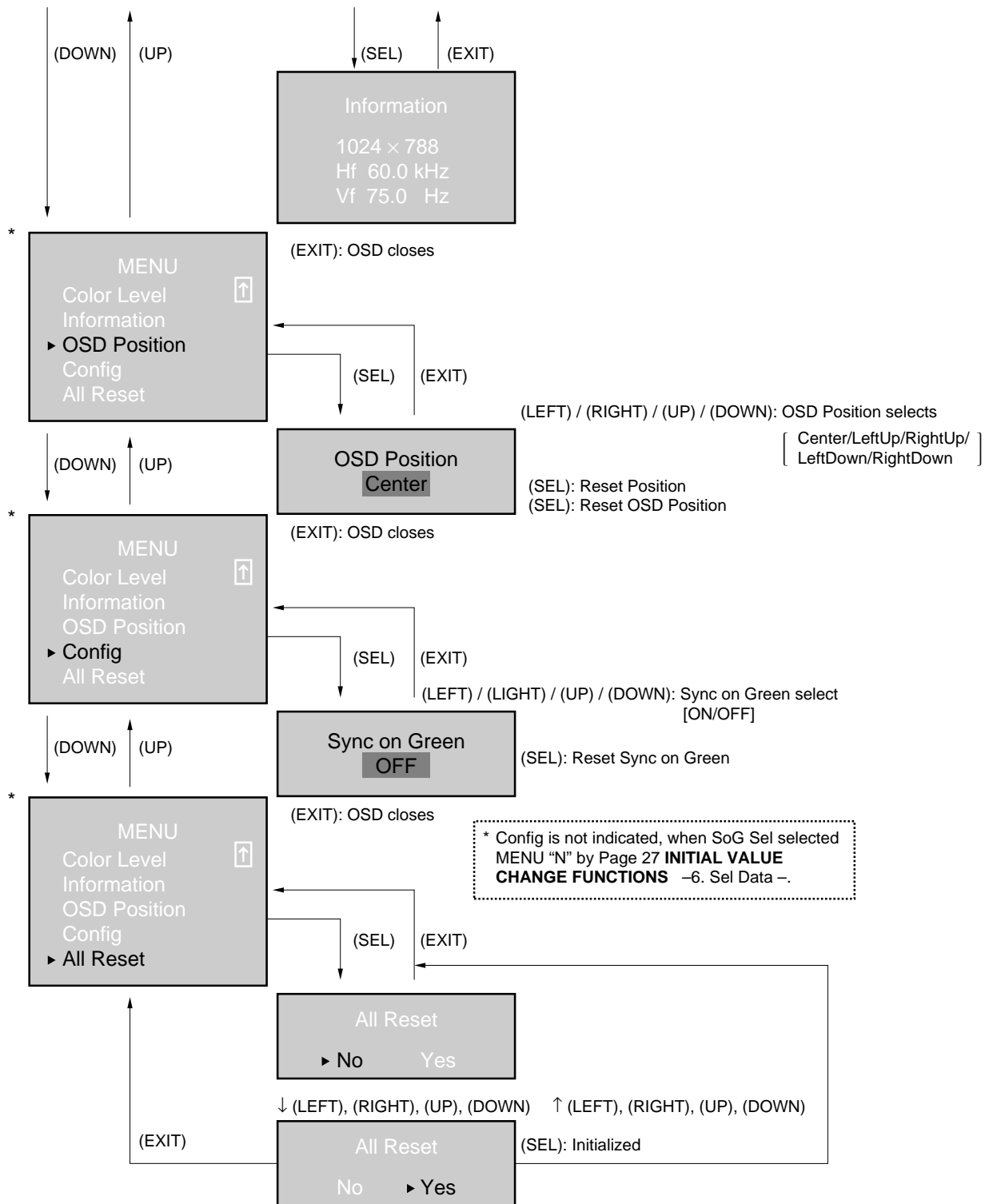

- Notes 1:** The value of the selected signals by LEFT, RIGHT, UP and DOWN key is continuously increased if the input signal is held for more than approx. one second. If it's less than one second, the value is increased by one.
- 2:** RESET signal initializes the value selected by SEL key. "All reset" function initializes all the values adjusted before.
- 3:** No key input for more than ten seconds shall be regarded as "Time out".
- 4:** Contrast W is synchronous with Contrast R, Contrast G, and Contrast B.
- 5:** Color Level W is synchronous with Color Level R, Color Level G and Color Level B.

(c) Toggle type (SEL, UP, DOWN and EXIT)

(UP), (DOWN): + or –
 (EXIT): Initialize

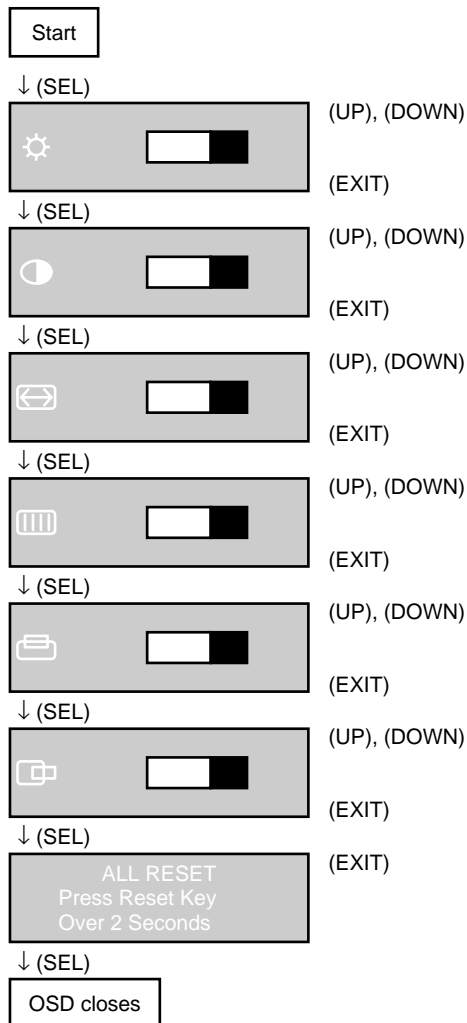

- Notes 1:** The value of the signals selected by UP and DOWN key is continuously increased if the input signal is held for more than approx. one second.
- 2:** RESET signal initializes the value selected by SEL key. All reset function initializes all the values adjusted before.
- 3:** No key input for more than five seconds shall be regarded as “Time out”.
- 4:** EXIT is valid when connected to GND for more than approx. two seconds.

(6) INITIAL VALUE CHANGE FUNCTIONS

Initial value, OSD items, etc. can be changed.

The changed initial value becomes initial value in each preset timing, and is applicable when it is reset (including All Reset).

- How to transpose to **initial value change mode**.
 Hierarchical type: Connect SET and UP to GND at the same time when OSD function is in “information” mode.
 Toggle type : Connect SEL to GND while UP is connected to GND when OSD function is in “All Reset” mode.

- Operation
 SEL, UP, DOWN, and EXIT

- How to return to normal mode
 Connect EXIT to GND or turn off Power supply when OSD is closed.
 Both LEDON and LEDOFF become “H” when this mode is operating.

No.	Form		Function items
1	Compatible		It becomes valid when Toggle menu type is only selected. YES : Sync on Green The initial value of contrast (RGB synchronous) becomes 128. NO : No Sync on Green The initial value of contrast (RGB synchronous) becomes 100. The NEC factory value: NO.
2	Brightness		The maximum value of brightness of backlight can be changed. Initial value: 100
3	Color Level		The initial value of color level can be changed. Initial value: 128
4	Contrast		The initial value of contrast can be changed. Initial value: 128 (When NO is selected by Compatible in Toggle menu type, the initial value of RGB synchronous only is 100. As for RGB synchronous, the setup value described in this item becomes valid as the Initial value regardless of the selections state of Compatible.)
5	LCD Data	Mode	No. of Page 12 PRESET TIMINGS is displayed.
		HSE	The initial value of the Double Value can be changed.
		Delay	The value of the CLK delay can be changed. (Initial value can not be changed.) Initial value: 0
		VD	The initial value of the up-down position of the display position can be changed.
		HD	The initial value of the left-right position of the display position can be changed.
		Auto Adjust	Auto adjust
		Par. Delay	The compensation value of Delay of the auto adjust can be changed. Valid range: 0 to 255
		Par. HD	The compensation value of horizontal position of the auto adjust can be changed. Valid range: 0 to 127

Continue to next page

No.	Form		Function items
5	LCD Data	LCD Reset	The values set in No. 5 LCD Data, return to the NEC factory settings
6	Sel Data	S – Lvl Sel	The adjustment of each individual RGB can be made impossible by the adjustment of the Color level. In this case, the adjustment item of each individual RGB is not displayed on the menu screen. ON : Individual adjustment is available. OFF : Individual adjustment is impossible Initial value: ON.
		S – Cnt Sel	The adjustment that RGB is independent can be made impossible by the adjustment of the Color level. In this case, the adjustment item that RGB is independent is not displayed on the menu screen. ON : Individual adjustment is available. OFF : Individual adjustment is impossible Initial value: ON.
		SOG Sel	Select or non-select of Sync on Green and display or non-display of select menu can be selected. When non-display is selected, Config is not displayed. • FUNC (Y: Sync on Green selection) (N: Sync on Green non-selection) • MENU (Y: Select MENU display.) (N: Select MENU non-display.) Initial value (FUNC: Y; MENU: N) * This item becomes effective only when the Hierarchical menu type is selected. But it becomes invalid when Toggle menu type is selected.
		MENU Sel	B (blue) or S (transparency) can be selected for the Background Color of the OSD menu. Initial value: B
		Button Sel	4 (SEL, UP, DOWN and EXIT) or 7 (SEL, UP, DPWN, RIGHT, LEFT, EXIT and RESET) number of adjustment switch can be selected. Initial value: 7
		PSOSD Sel	Display or no display for Power Save OSD can be selected. (For detail, see Page 29 INFORMARION DISPLAY BY OSD) ON: Display OFF: No display Initial value: OFF
7	Information		Input signal information is displayed.
8	OSD Position		The initial value of OSD display position can be changed. C: Center UL: Upper left UR: Upper right DL: Down left DR: Down right Initial value: C
9	Used Time		Used time in normal and Power save state is displayed. Used time is recorded in every five minutes. But it is not recorded when Power supply is cut off within five minutes.
10	Full Reset		All values are returned to NEC factory settings. It takes about seven seconds.

- * The value of No.5 LCD Data are memorized in every Preset timing.
- * Selected adjustment item is displayed with OSD.
- * Data except **Auto Adjust** of 5. LCD Data are saved when it is returned in the extreme upper menu. But it is not saved if the power supply is cut off halfway.
- * All adjust value is returned to the NEC factory value when menu type is changed.
- * Please sufficiently evaluate the compensation values that **Par. Delay** and **Par. HD** of No.5 LCD Data need to set up, before determining the values.

(7) INFORMARION DISPLAY BY OSD

- (a) Power save: Frequency of horizontal, vertical synchronous signal is displayed for four seconds at the time of the Power Save mode switchover.

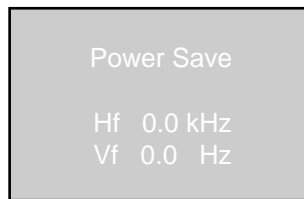

am

* It is displayed when Horizontal synchronous signal frequency (Hf) and vertical synchronous signal frequency (Vf) are the following cases:

- (1) $Hf < 10 \text{ KHz}$
- (2) $Vf < 40 \text{ Hz}$
- (3) (1) and (2)

* It is not displayed when "Power Save OSD no display" form is selected with Page 27 INITIAL VALUE CHANGE FUNCTIONS - 6. Sel Data, PSOSD Sel -.

- (b) Out of Range: Each frequency is displayed for four seconds when the Horizontal and Vertical synchronous signal outside the corresponding range is inputted.

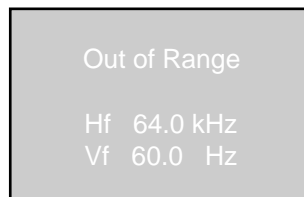

* It is displayed when Horizontal synchronous signal frequency (Hf) and vertical synchronous signal frequency (Vf) are the following cases:

- (1) $10 \text{ KHz} \leq Hf < 23 \text{ KHz}$ or $61.5 \text{ KHz} < Hf$
- (2) $40 \text{ Hz} \leq Vf < 50 \text{ Hz}$ or $200 \text{ Hz} < Vf$
- (3) (1) and (2)

But it is not displayed when either Hf or Vf is power save mode.

* Display or no display for **Out of Range** can not be selected.

- (c) Disable : It is displayed for four seconds if the switch for adjustment is disable.

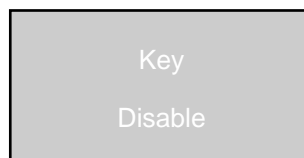

(8) INPUT SIGNAL AND DISPLAY POSITION - XGA STANDARD TIMING -

Pixels

D (0,0)	D (0,1)	D (0,2)	D (0,1023)
D (1,0)	D (1,1)	D (1,2)	D (1,1023)
D (2,0)	D (2,1)	D (2,2)	D (2,1023)
•	•	•			•
•	•	•			•
•	•	•			•
•	•	•			•
D (767,0)	D (767,1)	D (767,2)	D (767, 1023)

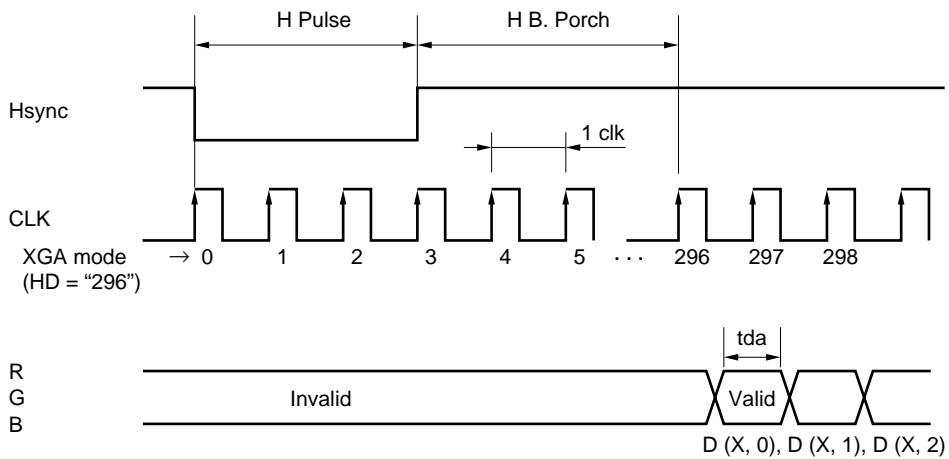
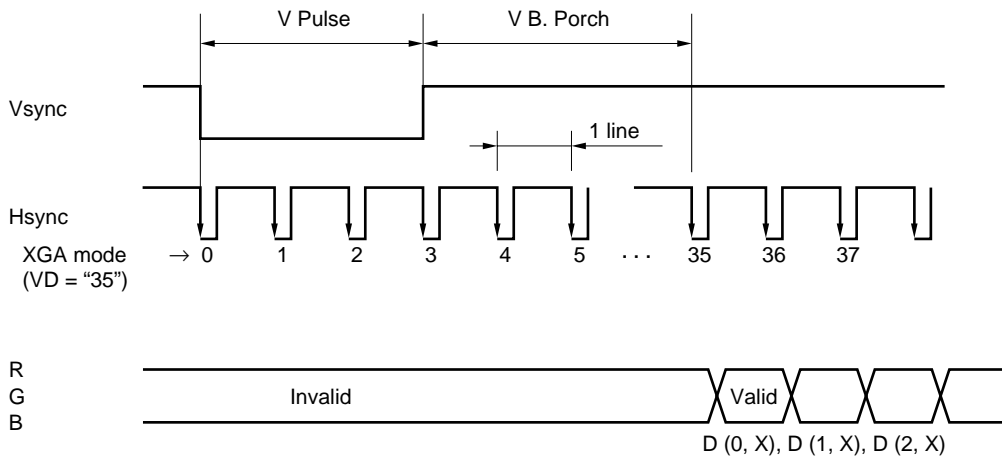

Note: The tda should be more than 4ns

OPTICAL CHARACTERISTICS

(Ta = 25°C, VDD = 12 V, VDDB = 12 V, **Note 1**)

Item	Symbol	Condition	Min.	Typ.	Max.	Unit	Remark
Contrast ratio	CR	$\gamma = 2.2$ viewing angle $\theta R = 0^\circ, \theta L = 0^\circ, \theta D = 0^\circ$, White/Black, at center	80	150	–	–	Note 2
Luminance	Lvmax	White, at center	150	200	–	cd/m ²	Note 3
Luminance uniformity	–	White	–	–	1.30	–	Note 4

Reference data

(Ta = 25°C, VDD = 12 V, VDDB = 12 V, **Note 1**)

Item	Symbol	Condition	Min.	Typ.	Max.	Unit	Remark
Contrast ratio	CR	Best contrast angle $\theta R = 0^\circ, \theta L = 0^\circ, \theta D = 5^\circ$ White/Black, at center	–	300	–	–	Note 2
Color gamut	C	$\theta R = 0^\circ, \theta L = 0^\circ, \theta U = 0^\circ, \theta D = 0^\circ$ at center, to NTSC	35	40	–	%	–
Viewing angle range	θR	CR > 10, $\theta U = 0^\circ, \theta D = 0^\circ$ White/Black, at center	40	50	–	deg.	Note 5
	θL		40	50	–	deg.	
	θU	CR > 10, $\theta R = 0^\circ, \theta L = 0^\circ$ White/Black, at center	15	20	–	deg.	
	θD		25	35	–	deg.	
Response time	Ton	Black (0 %) to White (90 %)	–	11	25	ms	Note 6
	Toff	White (100 %) to Black (10 %)	–	40	80		
Luminance control range	–	Maximum luminance: 100 % at center.	–	30 to 100	–	%	–

Notes 1: The luminance is measured after 20 minutes from the module works, with all pixels in “white.”

The typical value is measured after luminance saturation.

Display mode: VESA XGA-75 Hz

RGB input voltage: 0.7 Vp-p

Contrast: Default

2: The contrast ratio is calculated by using the following formula.

$$\text{Contrast ratio (CR)} = \frac{\text{Luminance with all pixels in "white"}}{\text{Luminance with all pixels in "black"}}$$

3: The luminance is measured after 20 minutes from the module works, with all pixels in “white”. The typical value is measured after luminance saturation, more than one hour after burn-in. The timing is XGA standard mode, preset No. 9.

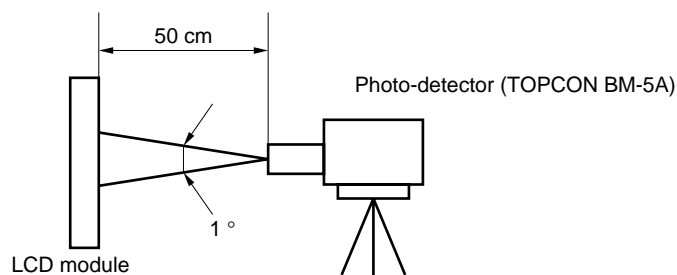

4: Luminance uniformity is calculated by using the following formula.

$$\text{Luminance uniformity} = \frac{\text{Maximum luminance}}{\text{Minimum luminance}}$$

The luminance is measured at near the five points shown below.

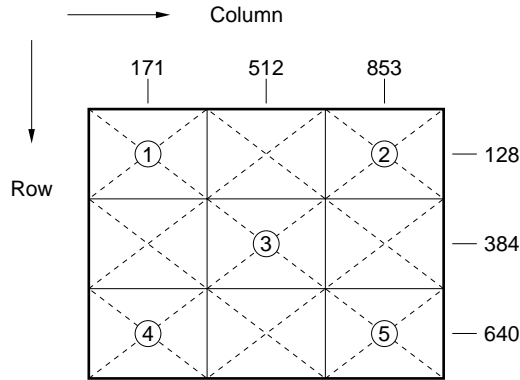

5: Definitions of viewing angle are as follows.

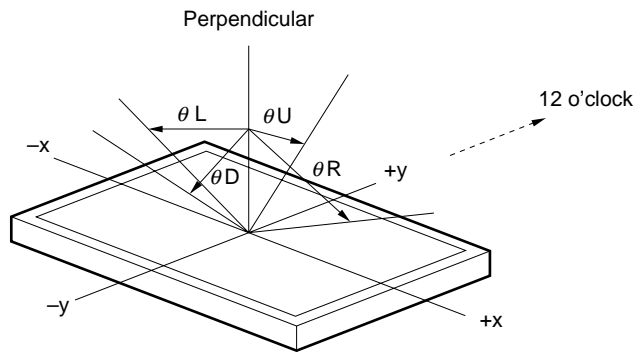

6: Definitions of response time is as follows.

Photo-detector output signal is measured when the luminance changes "white" to "black" or "black" to "white".

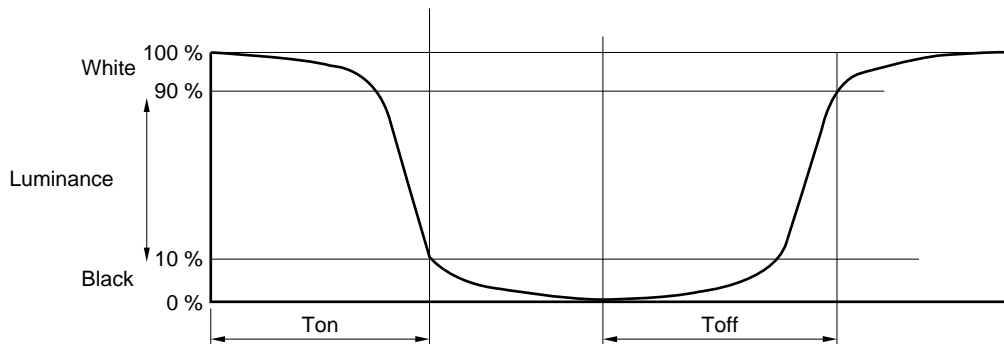

RELIABILITY TEST SPECIFICATIONS

Test item	Test condition	Judgment
High temperature/humidity operation	50 ±2°C, 85% relative humidity 240 hours, Display data is black.	Note 1
Heat cycle (operation)	<1> 0°C ±3°C ... 1 hour 55°C ±3°C ... 1 hour <2> 50 cycles, 4 hours/cycle <3> Display data is black.	Note 1
Thermal shock (non-operation)	<1> -20°C ±3°C ... 30 minutes 60°C ±3°C ... 30 minutes <2> 100 cycles <3> Temperature transition time is within 5 minutes.	Note 1
Vibration (non-operation)	<1> 5-100 Hz, 19.6 m/s ² (2G) 1 minute/cycle, X, Y, Z direction <2> 50 times each direction	Notes 1, 2
Mechanical shock (non-operation)	<1> 294 m/s ² (30G), 11 ms X, Y, Z direction <2> 3 times each direction	Notes 1, 2
ESD (operation)	150 pF, 150 Ω, ±10 KV 9 places on a panel 10 times each place at one-second intervals	Note 1 Note 3
Dust (operation)	15 kinds of dust (JIS-Z 8901) Hourly 15 seconds stir, 8 times repeat	Note 1

Notes 1: Display function is checked by the same condition as LCD module out-going inspection.

2: Physical damage.

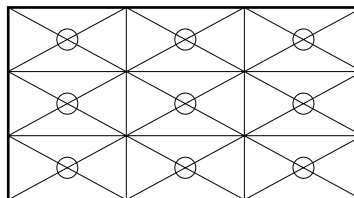

3: Discharge points are shown in the following figure.



GENERAL CAUTIONS

Because next figures and sentences are very important, please understand these contents as follows.

	CAUTION	This figure is a mark that you will get hurt and/or the module will have damages when you make a mistake to operate.
-----------------------------------------------------------------------------------	----------------	----------------------------------------------------------------------------------------------------------------------

	This figure is a mark that you will get an electric shock when you make a mistake to operate.	
	This figure is a mark that you will get hurt when you make a mistake to operate.	

 **CAUTION**

	Do not touch an inverter -- on which is stuck a caution label -- while the LCD module is under the operation, because of dangerous high voltage.
-----------------------------------------------------------------------------------	--------------------------------------------------------------------------------------------------------------------------------------------------

(1) Caution when taking out the module

Pick the pouch only, in taking out module from a carrier box.

(2) Cautions for handling the module

- a) As the electrostatic discharges may break the LCD module, handle the LCD module with care against electrostaic discharges.
- b)  As the LCD panel and backlight element are made from fragile glass material, impulse and pressure to the LCD module should be avoided.
- c) As the surface of polarizer is very soft and easily scratched, use a soft dry cloth without chemicals for cleaning.
- d) Do not pull the interface connectors in or out while the LCD module is operating.
- e) Put the module display side down on a flat horizontal plane.
- f) Handle connectors and cables with care.
- g) When the module is operating, do not lose CLK, HS or Vsync signal. If any one of these signals is lost, the LCD panel would be damaged.
- h) The torque to mounting screw should never exceed 0.392 N·m (4 kgf·cm).

(3) Cautions for the atmosphere

- a) Dew drop atmosphere should be avoided.
- b) Do not store and/or operate the LCD module in a high temperature and/or high humidity atmosphere. Storage in an electro-conductive polymer packing pouch and under relatively low temperature atmosphere, is recommended.
- c) This module uses cold cathod fluorescent lamps. Therefore, the life time of the lamps becomes short conspicuously at low temperature.
- d) Do not operate the LCD module in a high magnetic field.

(4) Caution for the module characteristics

- a) Do not apply the fixed pattern for a long time to the LCD module at product aging. Applying fixed pattern for a long time may cause image sticking.

(5) Other cautions

- a) Do not disassemble and/or reassemble LCD module.
- b) Do not readjust any variable resistors, switches, etc.
- c) When returning the module for repair etc., please pack the module not to be broken. We recommend to the original shipping packages.

Liquid Crystal Display has the following specific characteristics. There are neither defects nor malfunctions.

The display condition of LCD module may be affected by the ambient temperature.

The LCD module has cold cathode tube for backlight. Optical characteristics, like luminance or uniformity, will change during time.

Uneven brightness and/or small spots may be noticed depending on different display patterns.

Rear View (Unit in mm)

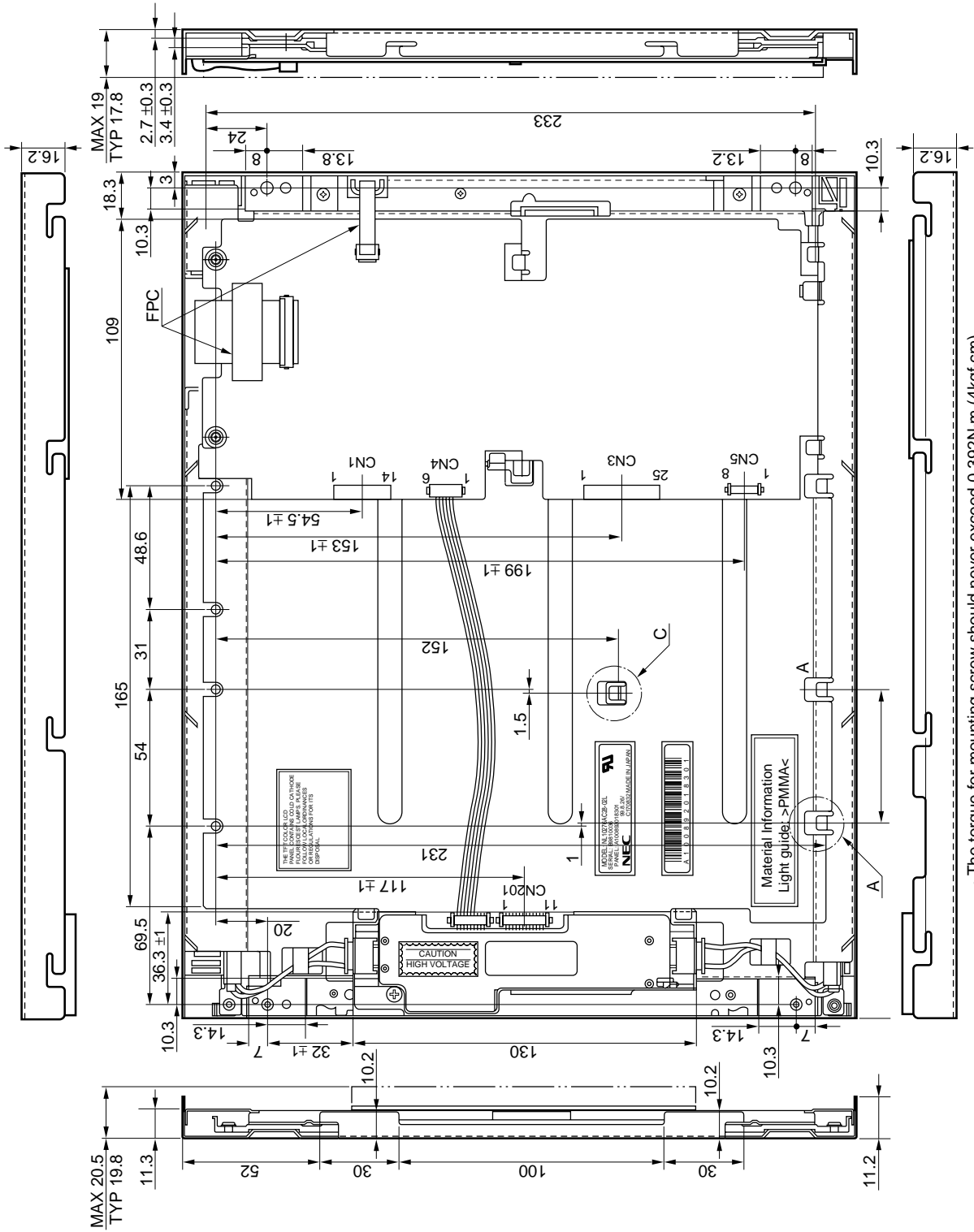

- The torque for mounting screw should never exceed 0.392N·m (4kgf·cm)
- Not shown tolerance of the dimensions are ±0.5 mm.

[MEMO]

[MEMO]

No part of this document may be copied or reproduced in any form or by any means without the prior written consent of NEC Corporation. NEC Corporation assumes no responsibility for any errors which may appear in this document.

NEC Corporation does not assume any liability for infringement of patents, copyrights or other intellectual property rights of third parties by or arising from use of a device described herein or any other liability arising from use of such device. No license, either express, implied or otherwise, is granted under any patents, copyrights or other intellectual property rights of NEC Corporation or others.

While NEC Corporation has been making continuous effort to enhance the reliability of its electronic components, the possibility of defects cannot be eliminated entirely. To minimize risks of damage or injury to persons or property arising from a defect in an NEC electronic component, customers must incorporate sufficient safety measures in its design, such as redundancy, fire-containment, and anti-failure features.

NEC devices are classified into the following three quality grades:

"Standard", "Special", and "Specific". The Specific quality grade applies only to devices developed based on a customer designated "quality assurance program" for a specific application. The recommended applications of a device depend on its quality grade, as indicated below. Customers must check the quality grade of each device before using it in a particular application.

Standard: Computers, office equipment, communications equipment, test and measurement equipment, audio and visual equipment, home electronic appliances, machine tools, personal electronic equipment and industrial robots

Special: Transportation equipment (automobiles, trains, ships, etc.), traffic control systems, anti-disaster systems, anti-crime systems, safety equipment and medical equipment (not specifically designed for life support)

Specific: Aircrafts, aerospace equipment, submersible repeaters, nuclear reactor control systems, life support systems or medical equipment for life support, etc.

The quality grade of NEC devices is "Standard" unless otherwise specified in NEC's Data Sheets or Data Books. If customers intend to use NEC devices for applications other than those specified for Standard quality grade, they should contact an NEC sales representative in advance.

Anti-radioactive design is not implemented in this product.