

FEATURES

- **COMMON MODE TRANSIENT IMMUNITY**
CMH: 2000 V/μs MIN, CML: 2000 V/μs MIN
- **HIGH ISOLATION VOLTAGE**
BV: 5000 V_{r.m.s.} MIN
- **HIGH SPEED RESPONSE**
t_{PLH}, t_{PHL}: 0.5 μs MAX
- **LOW INPUT CURRENT**
IFLH: 3 mA MAX @ V_{CC} = 24 V, T_A = 25 °C
IFLH: 5 mA MAX @ V_{CC} = 24 V, T_A = -25 °C to +85 °C

DESCRIPTION

PS9636 and PS9636L are optically coupled isolators containing a GaAlAs LED on the light emitting side (input side) and a photodiode and a signal processing circuit on the light receiving side (output side) on one chip. PS9636 is in a plastic DIP (Dual In-line Package) and PS9636L is in a lead bending type (Gull-wing) for surface mount.

APPLICATIONS

- INVERTER/MOSFET
- AIR CONDITIONER

ELECTRICAL CHARACTERISTICS (T_A = -20 °C to +85 °C, unless otherwise specified)

		PART NUMBER		PS9636, PS9636L		
SYMBOLS		PARAMETERS	UNITS	MIN	TYP	MAX
Diode	V _F	Forward Voltage, I _F = 10 mA, T _A = 25 °C	V	1.4	1.6	1.8
	I _R	Reverse Current, V _R = 5 V, T _A = 25 °C	μA			10
	C _i	Capacitance, V = 0, f = 1 MHz, T _A = 25 °C	pF		30	
	V _{CC}	Supply Voltage		15		35
Detector	V _{O1L}	Low Level Output Voltage (O1) V _{CC1} = 12 V, V _{CC2} = -12 V, I _F = 5 mA, I _{O1} = 0.1 A	V		0.1	0.4
	V _{O2H}	High Level Output Voltage (O2), V _{CC} = V _{O1} = 24 V, I _F = 5 mA, I _{O2} = -0.1 A	V	18	21	
	V _{O2L}	Low Level Output Voltage (O2), V _{CC} = 24 V, I _F = 0, I _{O2} = 0.1 A	V		1.0	2
	I _{O1L}	Leak Current (O1), I _F = 0, V _{CC} = V _{O1} = 35 V, T _A = 25 °C	μA			500
	I _{O2L}	Leak Current (O2), I _F = 5 mA, V _{CC} = V _{O2} = 35 V, T _A = 25 °C	μA			500
	I _{CCH1}	High Level Supply Current, V _{CC} = 24 V, I _F = 5 mA, T _A = 25 °C	mA		8.5	13
	I _{CCH2}	High Level Supply Current, V _{CC} = 24 V, I _F = 5 mA	mA			17
	I _{CCL1}	Low Level Supply Current, V _{CC} = 24 V, I _F = 0, T _A = 25 °C	mA		8	13
Coupled	I _{CCL2}	Low Level Supply Current, V _{CC} = 24 V, I _F = 0	mA			17
	I _{FLH1}	Threshold Input Current, Low → High, V _{CC} = 24 V, T _A = 25 °C	mA	0.1	0.4	3
	I _{FLH2}	Threshold Input Current, Low → High, V _{CC} = 24 V	mA			5
	R ₁₋₂	Isolation Resistance, V _{in-out} = 1 kV _{DC} , RH = 40 to 60%, T _A = 25 °C	Ω	10 ¹¹		
	t _{PLH}	Propagation Delay Time, Low → High V _{CC} = 24 V, I _F = 5 mA, T _A = 25 °C, C _G = 3000 pF, R _G = 47 Ω	μs		0.3	0.5
	t _{PHL}	Propagation Delay Time, High → Low V _{CC} = 24 V, I _F = 5 mA, R _G = 47 Ω, C _G = 3000 pF, T _A = 25 °C	μs		0.1	0.5
	t _r	Rise Time, V _{CC} = 24 V, I _F = 5 mA, T _A = 25 °C, C _G = 3000 pF, R _G = 47 Ω	μs		0.3	0.5
	t _f	Fall Time, V _{CC} = 24 V, I _F = 5 mA, T _A = 25 °C, R _G = 47 Ω, C _G = 3000 pF	μs		0.1	0.5
CMH	Common Mode Transient Immunity High Output Level V _{CM} = 600 V (peak), T _A = 25 °C, I _F = 5 mA, V _{CC} = 24 V, ΔV _{O2H} = 2 V	V/μs	2000			
CML	Common Mode Transient Immunity Low Output Level V _{CM} = 600 V (peak), T _A = 25 °C, I _F = 0, V _{CC} = 24 V, ΔV _{O2L} = 2 V	V/μs	2000			

ABSOLUTE MAXIMUM RATINGS¹ (T_A = 25°C)

SYMBOLS	PARAMETERS	UNITS	RATINGS
Diode			
I _F	Forward Current	mA	30
V _R	Reverse Voltage	V	6
Detector			
V _{CC}	Supply Voltage	V	35
I _{O1}	Output Current (O1)	A	0.1
I _{O1P}	Peak Output Current (O1) ³	A	0.4
I _{O2}	Output Current (O2)	A	0.1
I _{O2P}	Peak Output Current (O2) ³	A	0.4
V _{O1}	Output Voltage (O1)	V	35
P _O	Power Dissipation	mW	500
Coupled			
P _T	Total Power Dissipation	mW	550
BV	Isolation Voltage ²	V _{r.m.s.}	5000
T _{OP}	Operating Temperature	°C	-25 to +85
T _{STG}	Storage Temperature	°C	-55 to +125

Notes:

1. Operation in excess of any one of these parameters may result in permanent damage.
2. AC voltage for 1 minute at T_A = 25 °C, RH = 60 % between input and output.
3. PW ≤ 2.0 μs, Duty cycle 1 %.

RECOMMENDED OPERATING CONDITIONS

SYMBOLS	PARAMETERS	UNITS	MIN	TYP	MAX
I _{FLH}	Forward Current	mV	7		10
V _{CC}	Supply Voltage	V	20		30
I _{O1}	Output Current (O1)	A			0.1
I _{O2}	Output Current (O2)	A			0.1
T _{OP}	Operating Current	°C			+70



OUTLINE DIMENSIONS (Units in mm)

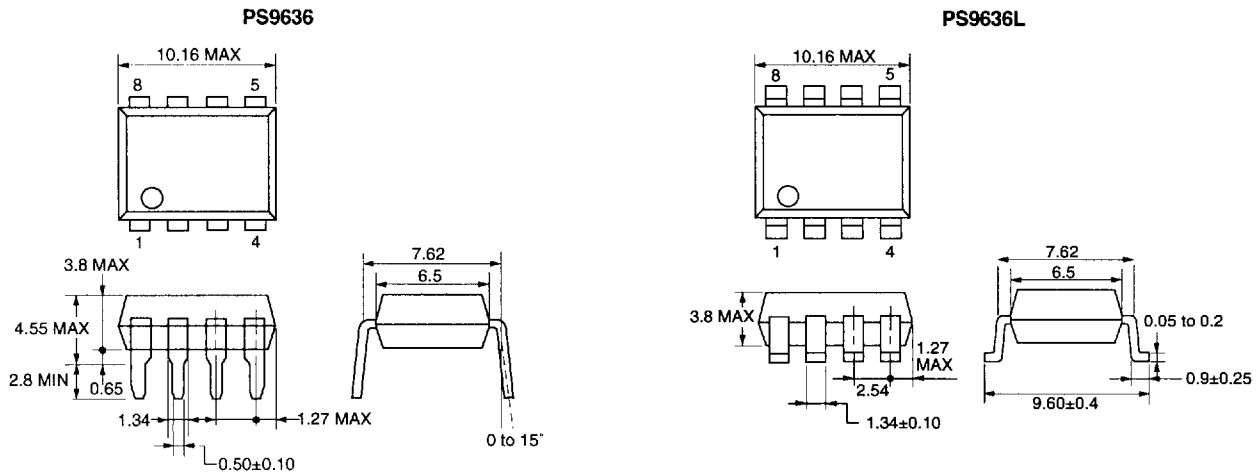

PIN CONNECTION (Top View)

PS9636, PS9636L

Signal processing circuit

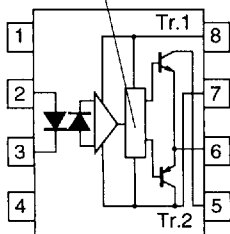

1. NC
2. Anode
3. Cathode
4. NC
5. Output (O1)
6. Output (O2)
7. GND
8. V_{CC}

MEASUREMENT CIRCUITS FOR ELECTRICAL CHARACTERISTICS

FIG. 1 (Vo1L)

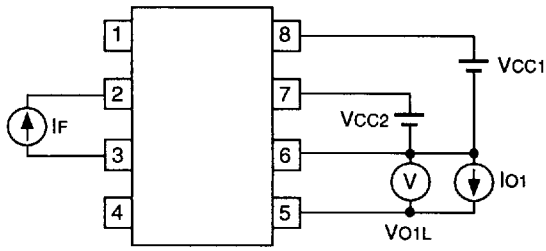

FIG. 2 (Vo2H)

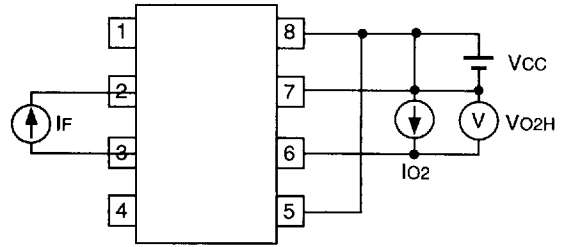

FIG. 3 (Vo2L)

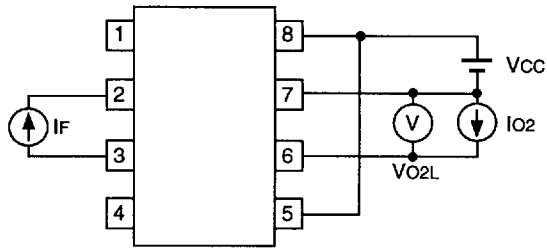

FIG. 4 (Io1L)

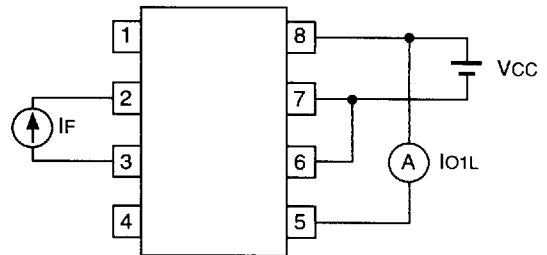

FIG. 5 (Io2L)

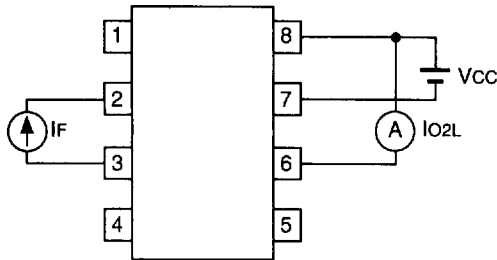

FIG. 6 (IcCL, IcCH)

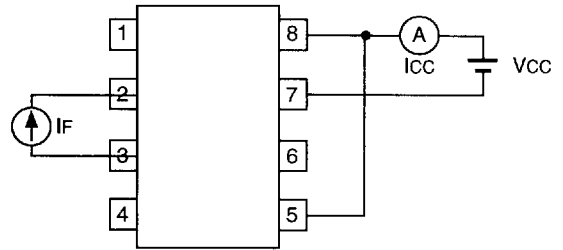

FIG. 7 (IFLH)

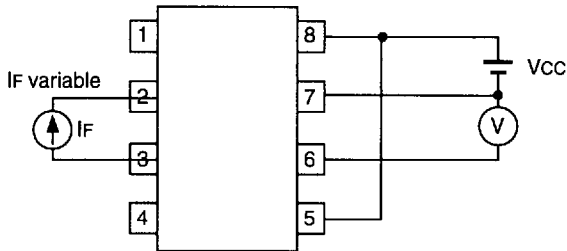
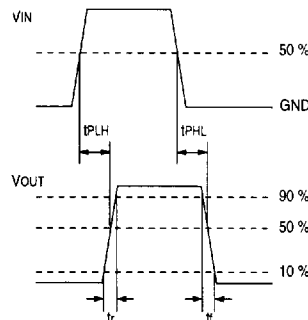
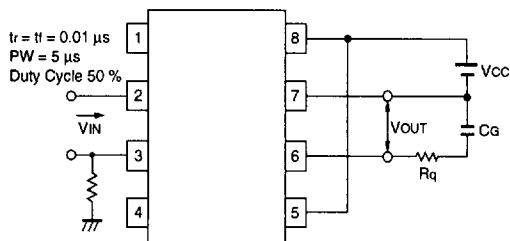
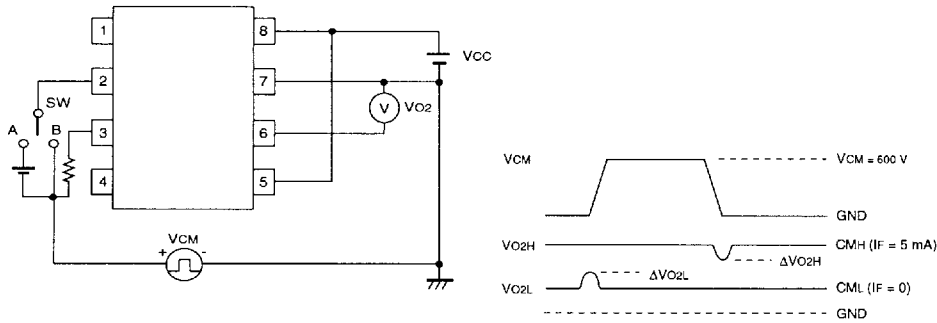

FIG. 8 (tPLH, tPHL)



MEASUREMENT CIRCUITS FOR ELECTRICAL CHARACTERISTICS (con't)

FIG. 9 (CMH, CML)



1