

SBD Type : FSH05A03LB

OUTLINE DRAWING

FEATURES

- *Similar to TO-220AB Case
- *Fully Molded Isolation
- *Extremely Low Forward Voltage Drop
- *Low Power Loss, High Efficiency
- *High Surge Capability
- *T_j=150 °C operation

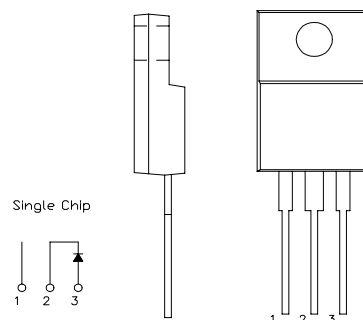

Maximum Ratings

Approx Net Weight: 1.75g

Rating	Symbol	FSH05A03LB		Unit
Repetitive Peak Reverse Voltage	V _{RRM}	30		V
Repetitive Peak Surge Reverse Voltage	V _{RRSM}	35(pulse width ≤ 1μs duty ≤ 1/50)		V
Average Rectified Output Current	I _O	5	T _c =132°C 50 Hz half Sine Wave Resistive Load	A
RMS Forward Current	I _{F(RMS)}	7.85		A
Surge Forward Current	I _{FSM}	120	50Hz Half Sine Wave ,1cycle Non-repetitive	A
Operating Junction Temperature Range	T _{jw}	-40 to +150		°C
Storage Temperature Range	T _{stg}	-40 to +150		°C
Mounting torque	F _{tor}	recommended torque = 0.5		N•m

Electrical • Thermal Characteristics

Characteristics	Symbol	Conditions	Min.	Typ.	Max.	Unit
Peak Reverse Current	I _{RM}	T _j = 25°C, V _{RM} = V _{RRM}	-	-	1	mA
Peak Forward Voltage	V _{FM}	T _j = 25°C, I _{FM} = 5 A	-	-	0.57	V
Thermal Resistance	R _{th(j-c)}	Junction to Case	-	-	5	°C/W
	R _{th(c-f)}	Case to Fin	-	-	1.5	°C/W

FSH05A03LB OUTLINE DRAWING (Dimension in mm)

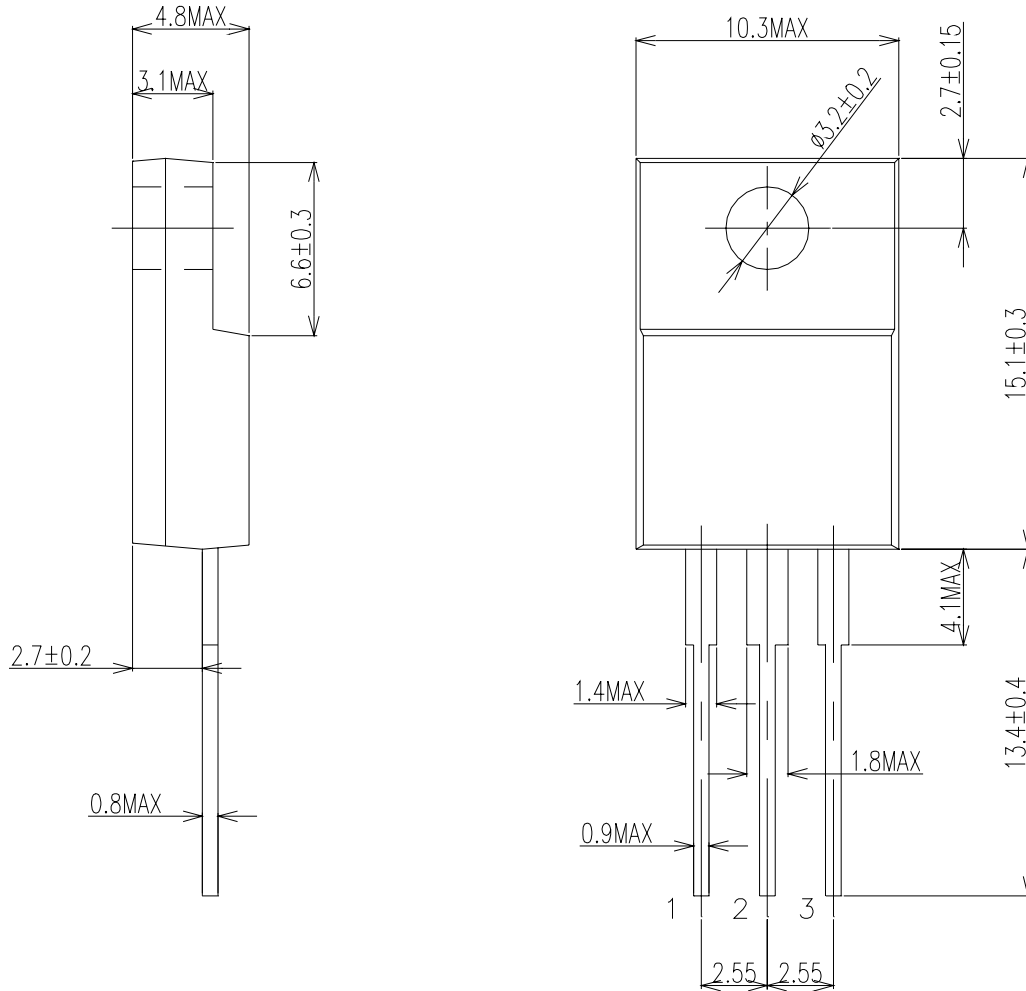

Single Chip

