

FEATURES

- Low power-loss(Dropout voltage:Max.0.5 V@ IO=1A)
- Line-up for 5V and 9V output type
- Compact resin package(TO-220 package)
- High-precision output voltage type (Output voltage precision: $\pm 3.0\%$)
- Built-in ON/OFF control function
- Built-in overcurrent protection, overheat protection, ASO protection circuit
- Lead forming type is also available.

APPLICATIONS

- Power supplies for varies electronic equipment such as AV, OA equipment

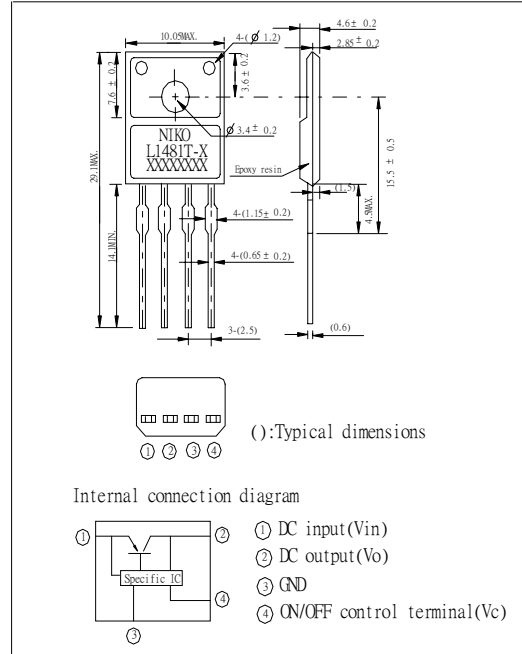

TYPICAL APPLICATION

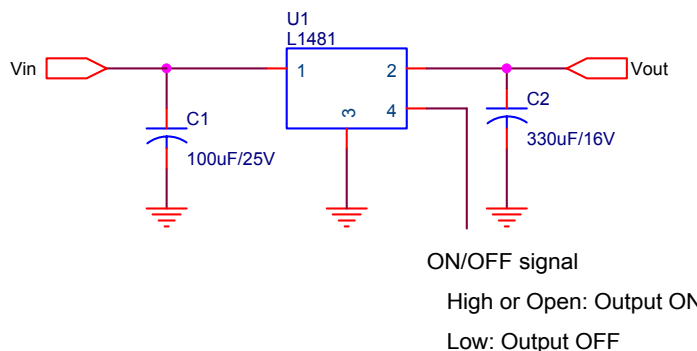

- Basic Adjustable Regulator Circuit -

ABSOLUTE MAXIMUM RATINGS

● Input Supply Voltage, $V_{IN}^{(1)}$	20V	● Operating Ambient Temperature Range	-20 to 80 °C
● On/Off Control Terminal Voltage, $V_{CTRL}^{(1)}$	20V		
● Power Dissipation	1.4W(No Heat Sink) 15W(Infinite heat sink)	● Storage Temperature Range	-40 to 150 °C
● Junction Temperature ⁽²⁾	150°C	● Lead Temperature (Soldering, 10 Seconds)	260 °C
● Output Current	1A		

(1) All are open except GND and applicable terminals

(2) Overheat protection may operate at $125 \leq T_j \leq 150^\circ\text{C}$.

ELECTRICAL CHARACTERISTICS (Unless otherwise specified, $T_A = 25^\circ\text{C}$.)

Parameter	Symbol	Test Conditions	Typical	Limits
Output Voltage	V_o	(3), $I_{OUT} = 0.5A$	9	$8.73V_{Min}$ $9.27V_{Max}$
Dropout Voltage	V_D	(5)		0.5V
Line Regulation	$REG_{(LINE)}$	(4), $I_{OUT} = 5mA$	0.5%	2.5%
Load Regulation	$REG_{(LOAD)}$	(3), $5mA \leq I_{OUT} \leq 1A$	0.1%	2.0%
Temperature coefficient of output voltage	$T_C V_o$	$T_j = 0$ to 125°C , $I_o = 5mA$	$\pm 0.02\%/^\circ\text{C}$	
ON-state voltage for control	$V_{C(ON)}$	(3)		2.0V min
ON-state current for control	$I_{C(ON)}$	$V_{CTRL} = 2.7V$, (3)		20uA Max
OFF-state voltage for control	$V_{C(OFF)}$	(3)		0.8V Max
OFF-state current for control	$I_{C(OFF)}$	$V_{CTRL} = 0.4V$, (3)		-0.4mA Max
Quiescent Current	I_Q	$I_o = 0A$, (3)		10mA Max
Ripple Rejection Ratio	R_A	Refer to Fig.2 Test Circuit of Ripple Rejection	55dB	45dB (Min)

(3) L1481T-9: $V_{in} = 11V$

(4) L1481T-9: $V_{in} = 10 \sim 16V$

(5) Input voltage shall be the value when output voltage is 95% in comparison with the initial value.

(6) In case of opening control terminal, output voltage turns on.

Typical Performance Characteristics

Output Voltage vs. Input Voltage(L1481T-9)

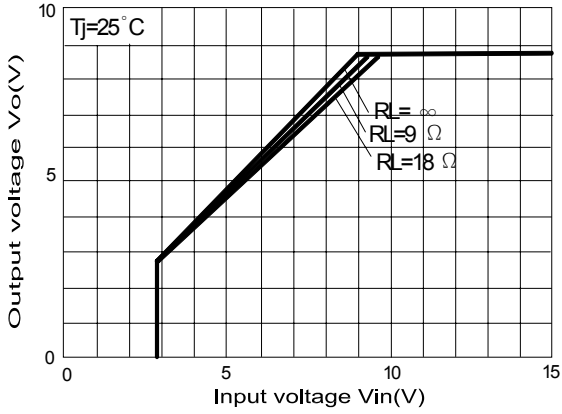

Circuit Operating current vs. Input Voltage (L1481T-9)

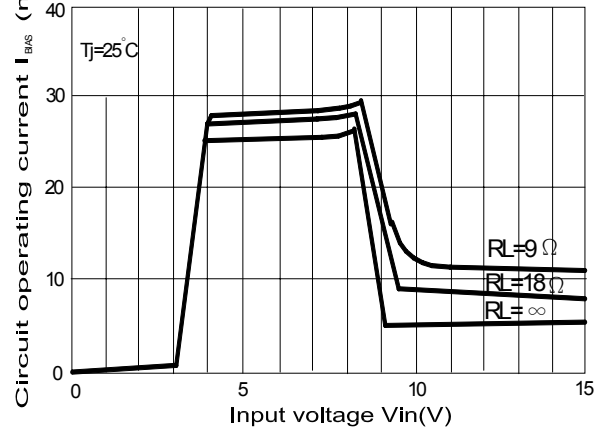

Output Voltage vs. Disable Voltage(L1481T-9)

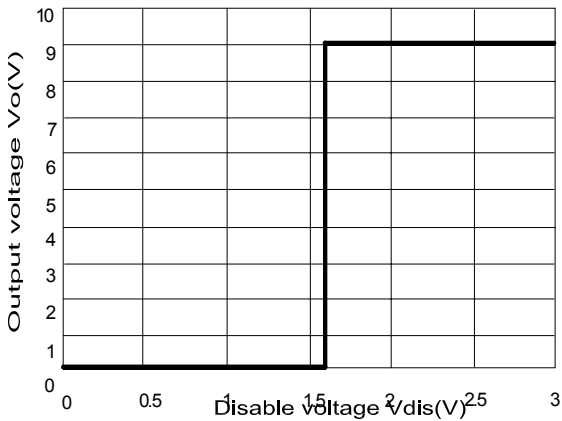

Output Voltage vs. Temperature(Tj)(L1481T-9)

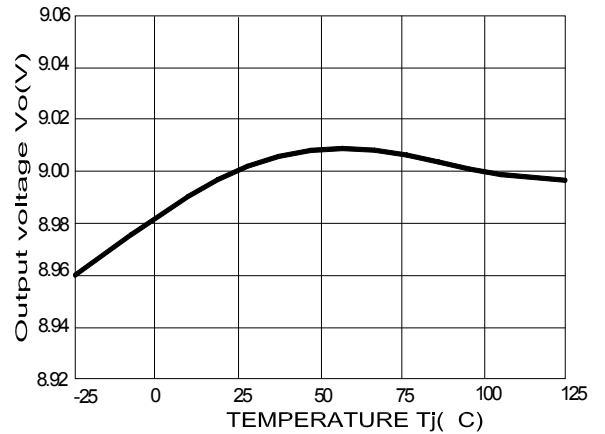

Dropout Voltage vs. Junction Temperature(Tj) (L1481T-9)

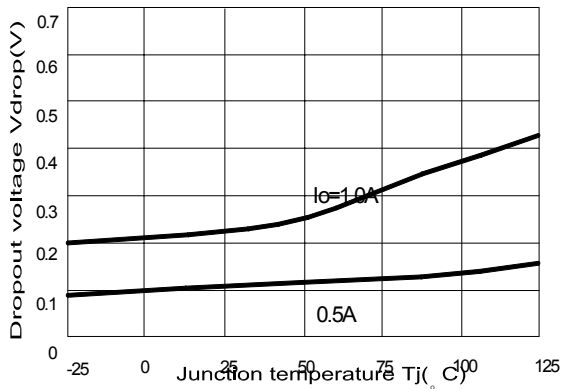

Overcurrent Protection Characteristics (Typical Value)(L1481T-9)

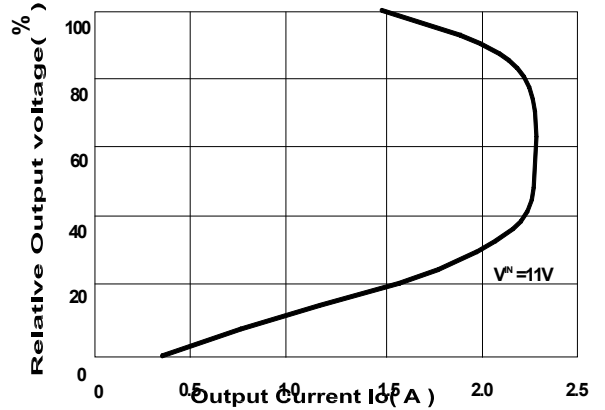

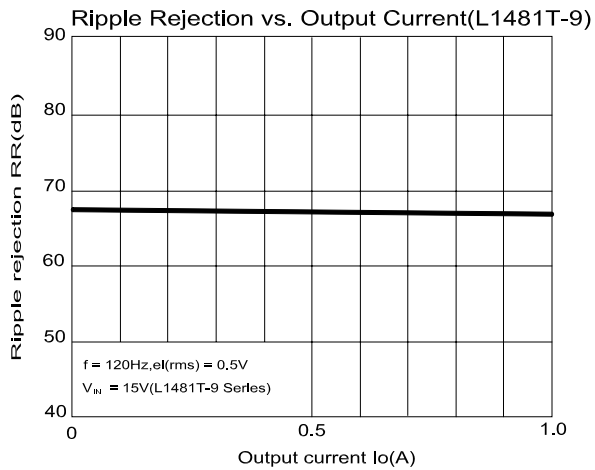
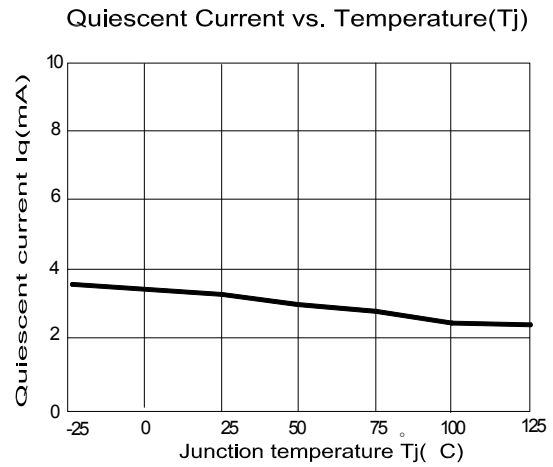
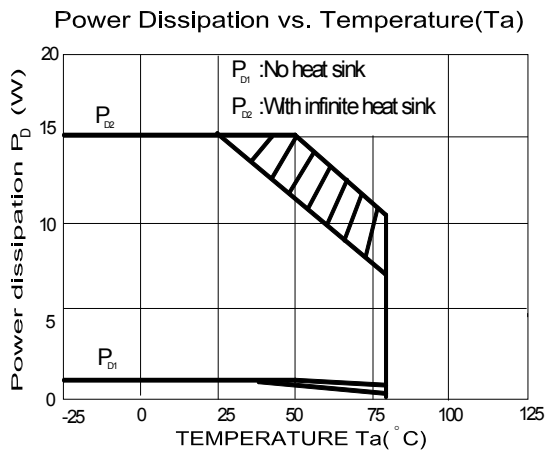

Fig.1 Test Circuit

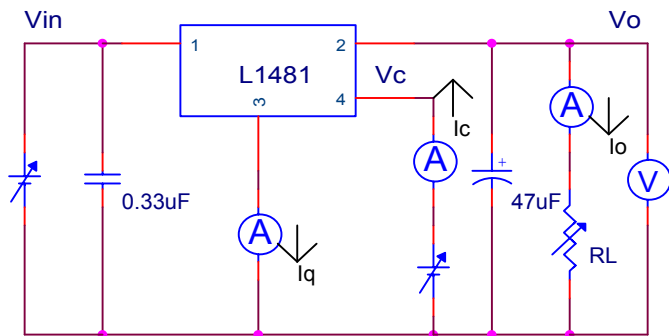
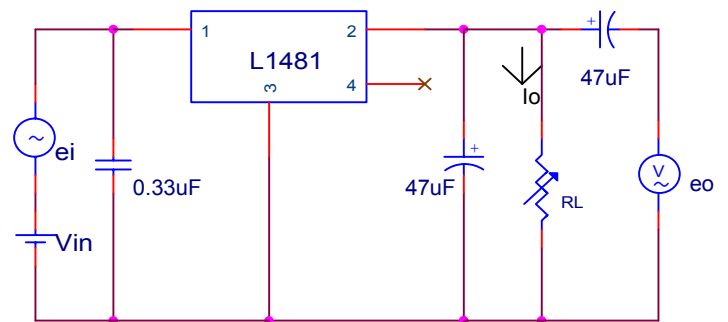

Fig.2 Test Circuit of Ripple Rejection



$f = 120\text{Hz (sine wave)}$ $I_o = 0.5\text{A}$
 $e_i(\text{RMS}) = 0.5\text{V}$ $RR = 20 \log [e_i(\text{RMS}) / e_o(\text{RMS})]$
 $V_{in} = 15\text{V (L1481T-9)}$

DEVICE SELECTION GUIDE

Device	L1481T-9
Package	TO-220
Marking	L1481T-9

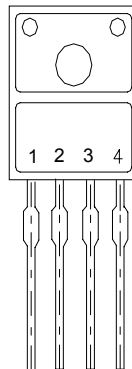
PIN CONFIGURATIONS

Pin #	Function
1	Vin
2	Vo
3	GND
4	ON/OFF Control

TO-220 (4-Lead) MECHANICAL DATA

Dimension	mm			Dimension	mm		
	Min.	Typ.	Max.		Min.	Typ.	Max.
A		10.5		H	3.4	3.6	3.8
B	7.4	7.6	7.8	I	4.4	4.6	4.8
C		29.1		J	2.65	2.85	3.05
D		14.1		K	15	15.5	16
E		2.5		L		4.5	
F	0.63	0.65	0.67	M		1.5	
G	1.13	1.15	1.17	N		0.6	

