

## SPDT SWITCH GaAs MMIC

### ■GENERAL DESCRIPTION

NJG1506R is a GaAs SPDT switch IC which features low loss, high isolation and low control current and ideally suitable for switching the RF receiving circuit of cellular phone.

NJG1506R is operated in the wide frequency range from 50MHz to 3GHz at low voltage from 2.5V with a small VSP8 package.

### ■PACKAGE OUTLINE

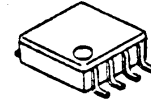

NJG1506R

### ■FEATURES

- Single and low positive supply voltage +2.5~+5.5V
- Low insertion loss 0.3dB typ. @f=1GHz,  $P_{in}=0\text{dBm}$
- High isolation 28dB typ. @f=1GHz,  $P_{in}=0\text{dBm}$
- Transmission Power 19dBm max. @f=2GHz,  $V_{CTR}=3.0\text{V}$
- Low control current 1uA typ. @f=0.05~2.5GHz,  $P_{in}=10\text{dBm}$
- Package VSP8 (Mount Size: 4.0x2.9x1.2mm)

### ■PIN CONFIGURATION

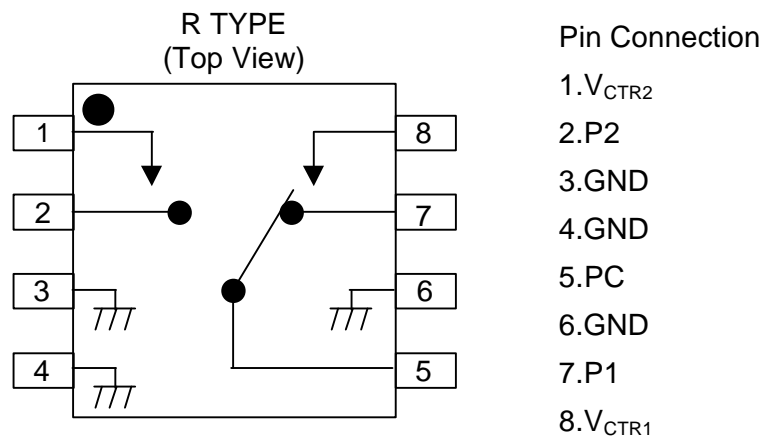

### ■TRUTH TABLE

“H”= $V_{CTR(H)}$ , “L”= $V_{CTR(L)}$

$V_{CTL1}$	H	L	L	H
$V_{CTL2}$	L	H	L	H
P1-PC	OFF	ON	Loss =15dB $P_1$ Return Loss =-3dB	Loss =16dB $P_1$ Return Loss =-2dB
P2-PC	ON	OFF	Loss =15dB $P_2$ Return Loss =-3dB	Loss =16dB $P_2$ Return Loss =-2dB

Note) The values of "Loss" and "Return Loss" are typical values at 2.0GHz.

# NJG1506R

## ■ABSOLUTE MAXIMUM RATINGS

( $T_a=25^{\circ}\text{C}$ ,  $Z_s=Z_l=50\Omega$ )

PARAMETER	SYMBOL	RATINGS	UNITS
Input power	$P_{in}$	28	dBm
Control voltage	$V_{CTR}$	6.0	V
Power dissipation	$P_D$	320	mW
Operating Temp.	$T_{opr}$	-30~+85	$^{\circ}\text{C}$
Storage Temp.	$T_{stg}$	-40~+150	$^{\circ}\text{C}$

## ■ELECTRICAL CHARACTERISTICS

( $V_{CTR(L)}=0\text{V}$ ,  $V_{CTR(H)}=2.7\text{V}$ ,  $Z_s=Z_o=50\Omega$ ,  $T_a=25^{\circ}\text{C}$ )

PARAMETER	SYMBOL	CONDITIONS	MIN	TYP	MAX	UNITS
Control voltage (L)	$V_{CTR(L)}$	$f=0.05\sim 2.5\text{GHz}$ , $P_{in}=10\text{dBm}$	-0.2	0	0.2	V
Control voltage (H)	$V_{CTR(H)}$	$f=0.05\sim 2.5\text{GHz}$ , $P_{in}=10\text{dBm}$	2.5	2.7	5.5	V
Control current	$I_{CTR}$	$f=0.05\sim 2.5\text{GHz}$ , $P_{in}=10\text{dBm}$	-	1.0	2.0	$\mu\text{A}$
Insertion loss1	LOSS1	$f=1.0\text{GHz}$ , $P_{in}=0\text{dBm}$	-	0.3	0.6	dB
Insertion loss2	LOSS2	$f=2.0\text{GHz}$ , $P_{in}=0\text{dBm}$	-	0.5	0.8	dB
Isolation 1 (PC-P1, PC-P2, P1-P2)	ISL1	$f=1.0\text{GHz}$ , $P_{in}=0\text{dBm}$	25	28	-	dB
Isolation 2 (PC-P1, PC-P2, P1-P2)	ISL2	$f=2.0\text{GHz}$ , $P_{in}=0\text{dBm}$	23	27	-	dB
Pin at 1dB compression point	$P_{-1\text{dB}}$	$f=2.0\text{GHz}$	19.0	22.0	-	dBm
VSWR	VSWR	$f=0.05\sim 2.5\text{GHz}$ , ON STATE	-	1.2	1.5	
Switching time	$T_{SW}$	$f=0.05\sim 2.5\text{GHz}$	-	15	-	ns

## ■ TYPICAL CHARACTERISTICS

**(PC-P1) Insertion loss vs. Frequency**

(  $V_{CT1}=0V/2.7V$  ,  $P_{i1}=0dBm$  )

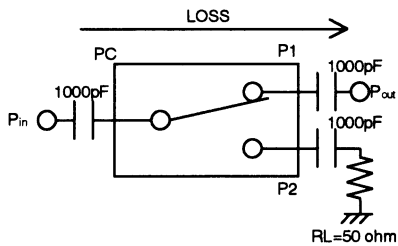
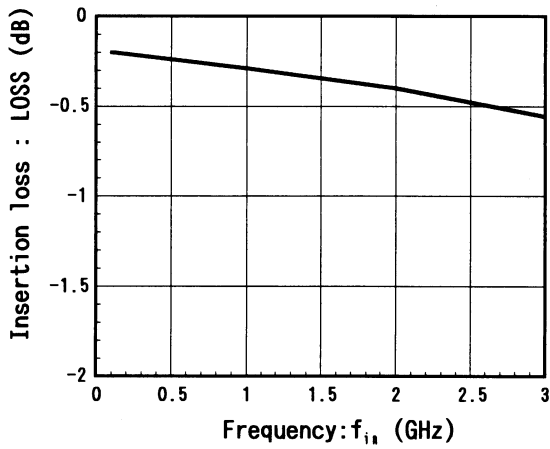

**(PC-P2) Insertion loss vs. Frequency**

(  $V_{CT1}=0V/2.7V$  ,  $P_{i1}=0dBm$  )

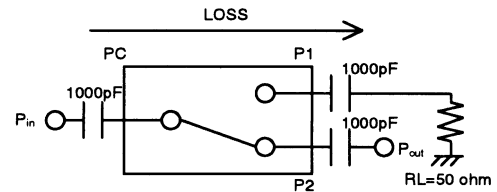
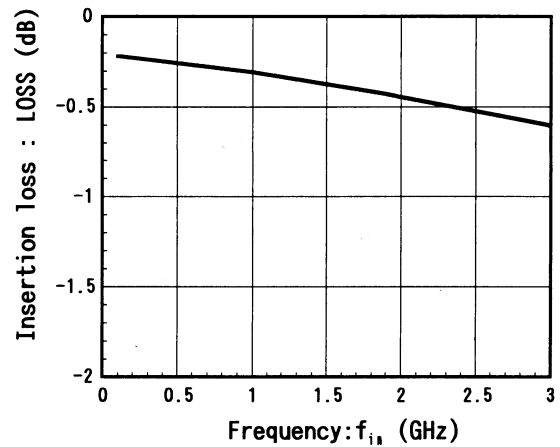

**(PC-P1) Isolation vs. Frequency**

(  $V_{CT1}=0V/2.7V$  ,  $P_{i1}=0dBm$  )

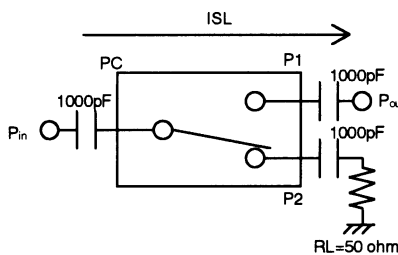
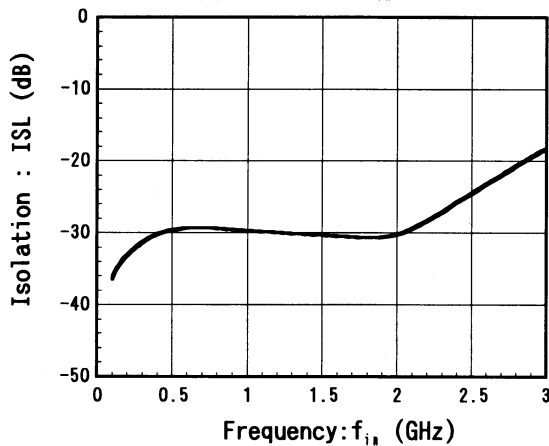

**(PC-P2) Isolation vs. Frequency**

(  $V_{CT1}=0V/2.7V$  ,  $P_{i1}=0dBm$  )

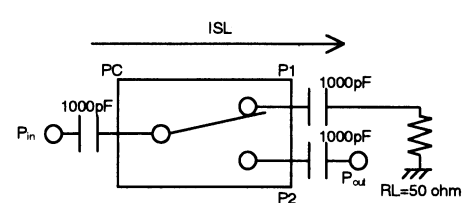
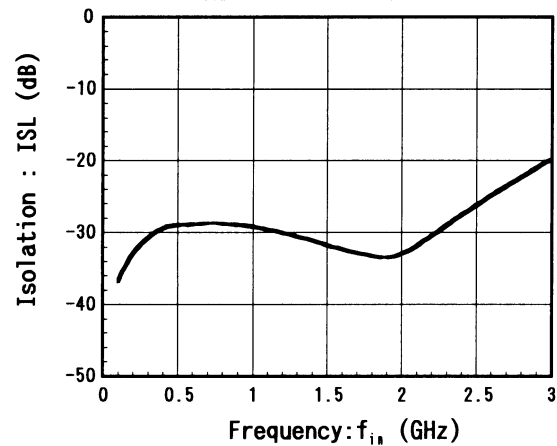

# NJG1506R

## TYPICAL CHARACTERISTICS

**P1-PC(ON) V.S.W.R vs. Frequency**  
 (  $V_{cT1}=0V/2.7V$  ,  $P_{i1}=0dBm$  )

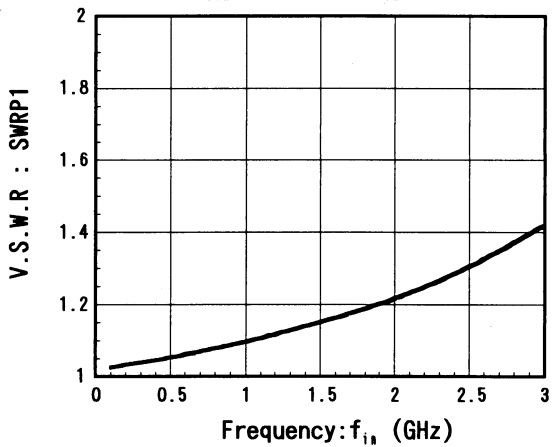

**P2-PC(ON) V.S.W.R vs. Frequency**  
 (  $V_{cT1}=0V/2.7V$  ,  $P_{i1}=0dBm$  )

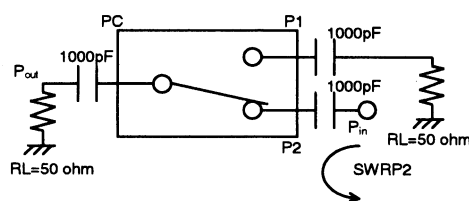
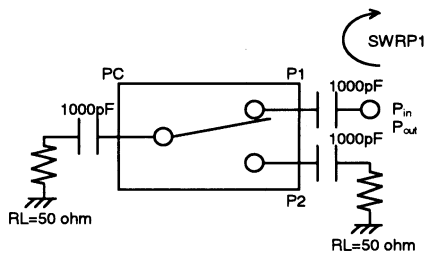
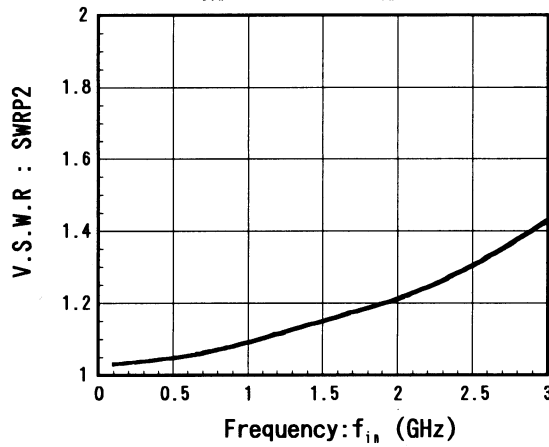

**PC-P1(ON)V.S.W.R vs. Frequency**  
 (  $V_{cT1}=0V/2.7V$  ,  $P_{i1}=0dBm$  )

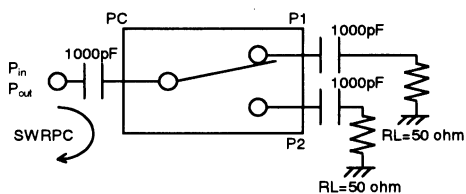
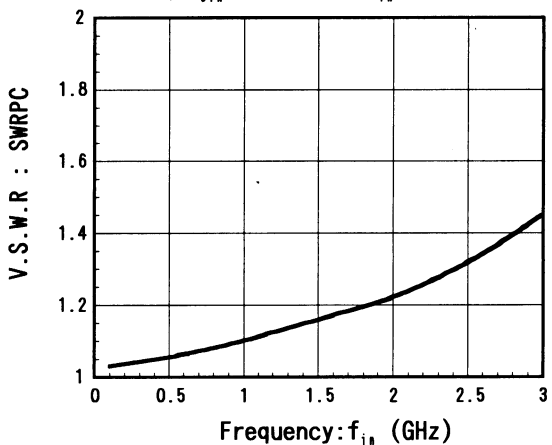

## ■ TYPICAL CHARACTERISTICS

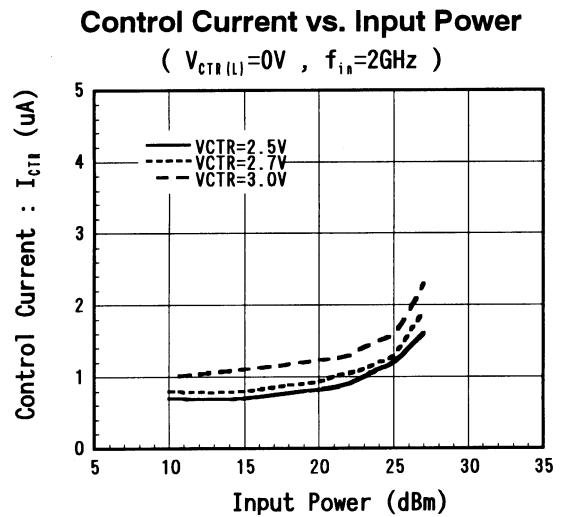
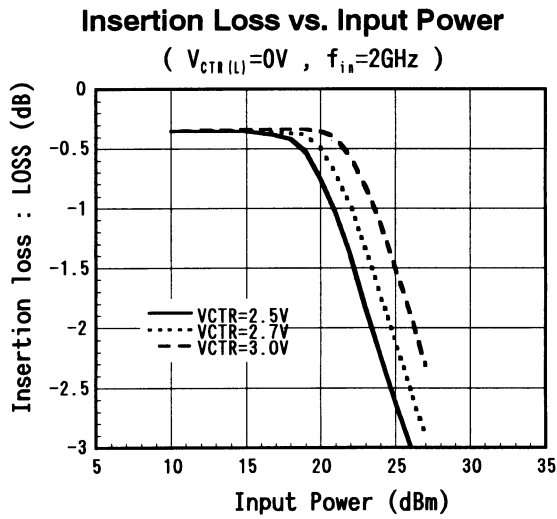
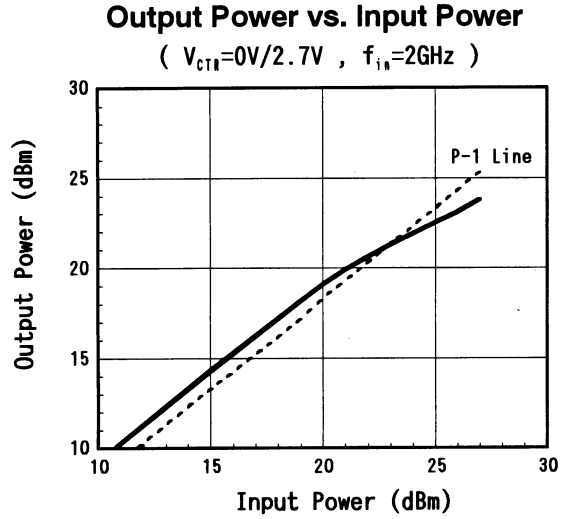
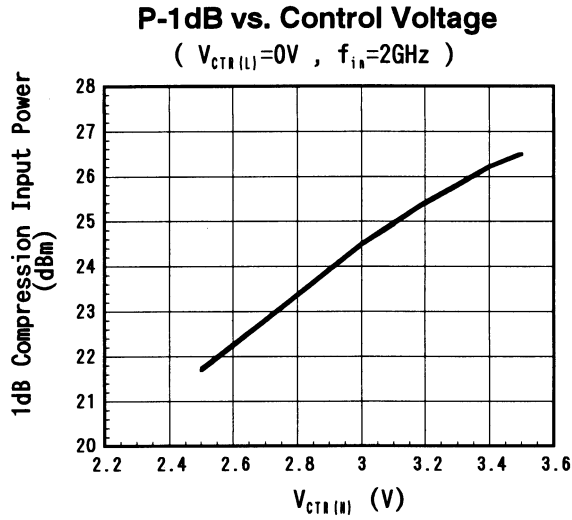

# NJG1506R

## TYPICAL CHARACTERISTICS

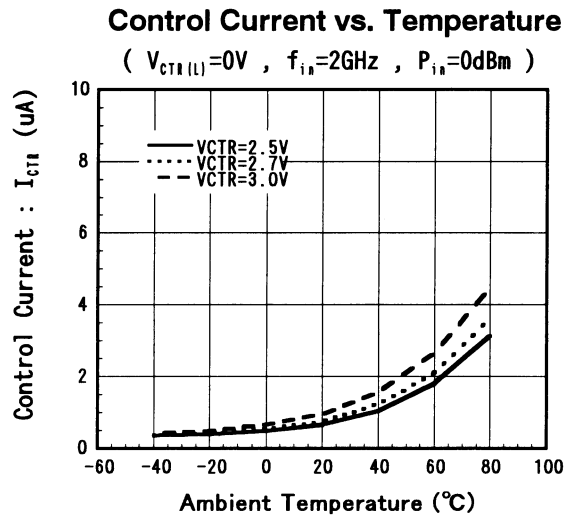
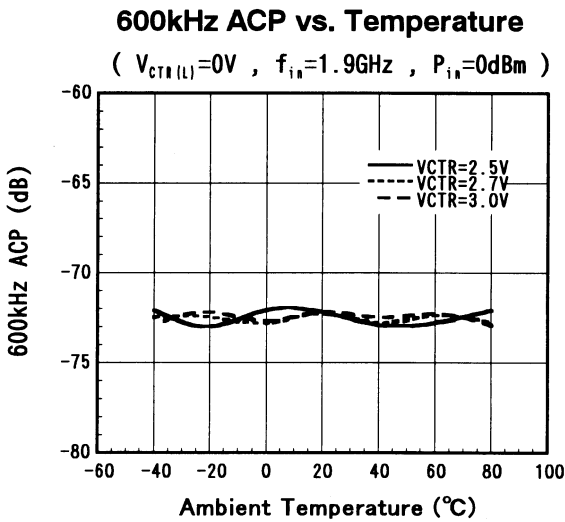
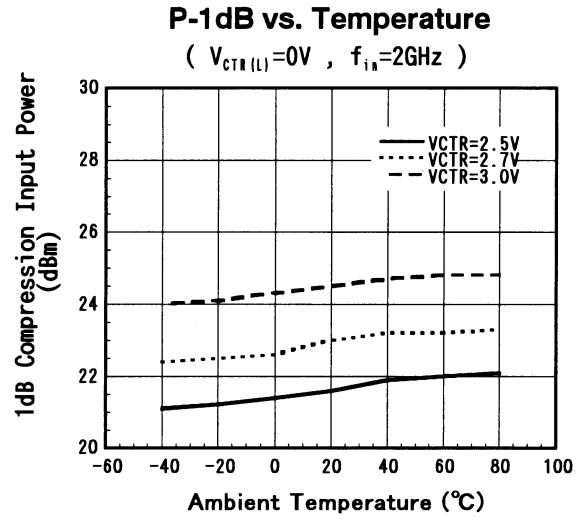
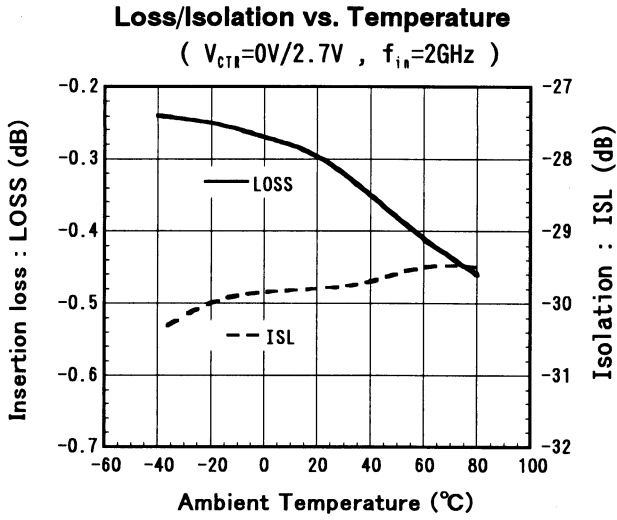

## ■ TYPICAL CHARACTERISTICS

Harmonics (Ta=25°C)

$f_{in}=1.9\text{GHz}$   $P_{in}=0\text{dBm}$   $V_{CTR(H)}=2.7\text{V}$

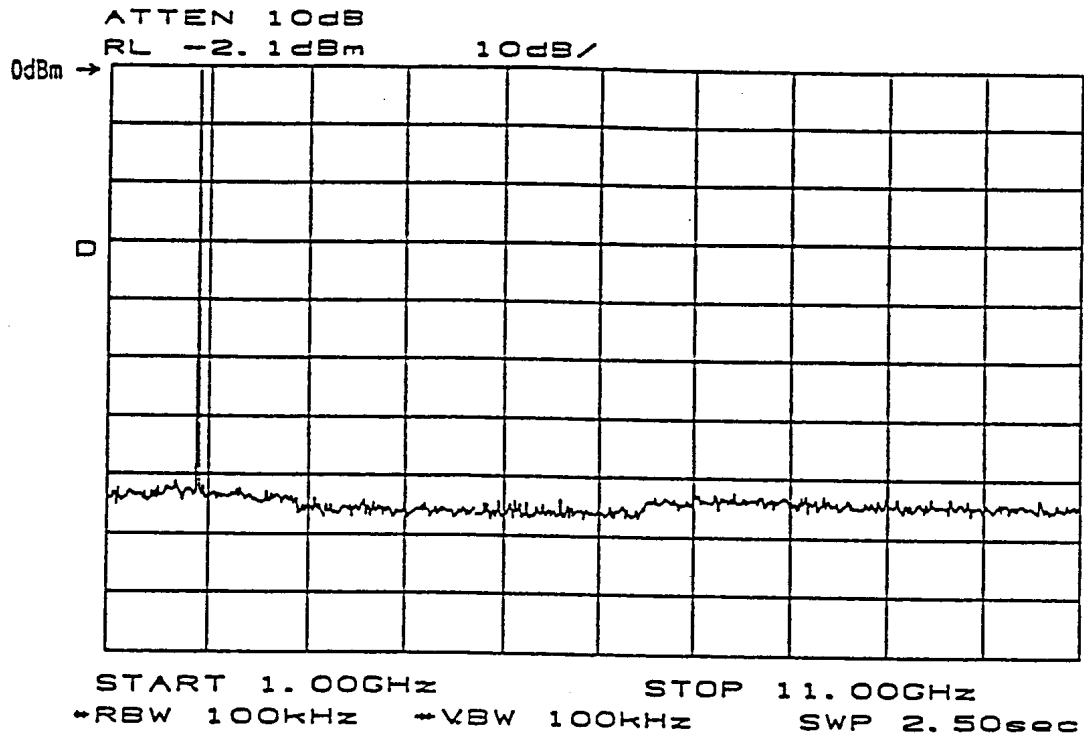

# NJG1506R

## TYPICAL CHARACTERISTICS

### P1 PORT IMPEDANCE (OFF STATE)

REF 1.0 Units  
 2 200.0 mUnits/  
 ▽ 6.2329 Ω 2.0117 Ω

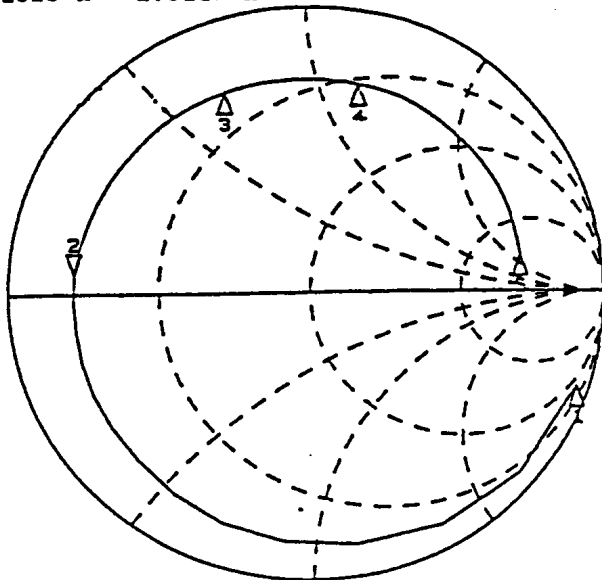

START 0.050000000 GHz  
 STOP 3.000000000 GHz

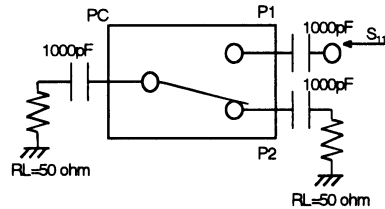

MARKER	f (MHz)	Mag.	Ang. (∠°)
1	50	0.957	-20.2
2	800	0.782	171.2
3	1500	0.759	102.0
4	2000	0.747	61.8
5	3000	0.710	-11.3

### P2 PORT IMPEDANCE (OFF STATE)

REF 1.0 Units  
 2 200.0 mUnits/  
 ▽ 6.8921 Ω 511.47 mΩ

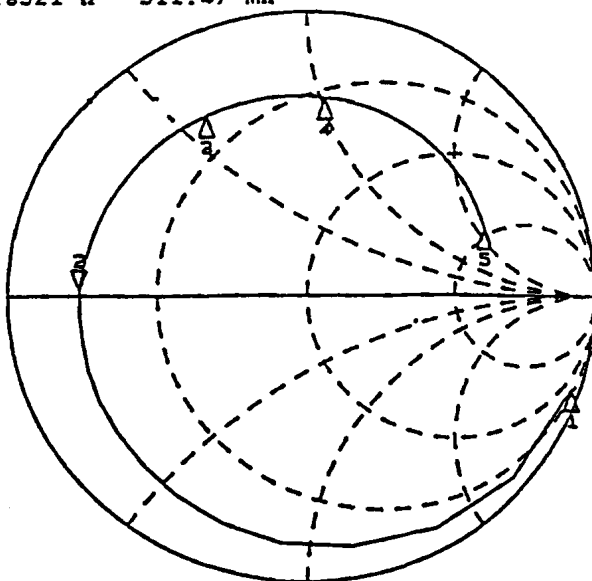

START 0.050000000 GHz  
 STOP 3.000000000 GHz

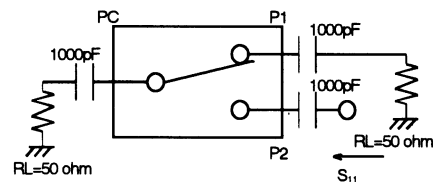

MARKER	f (MHz)	Mag.	Ang. (∠°)
1	50	0.968	-20.2
2	800	0.782	174.5
3	1500	0.749	108.2
4	2000	0.734	69.5
5	3000	0.690	-1.2



## ■ TYPICAL CHARACTERISTICS

### Scattering Parameters: S11 (OFF STATE)

( $V_{CTR}=0/2.7V$ ,  $50\Omega$ System)

f(MHz)	P1 PORT		P2 PORT	
	Mag.	Ang.( $\angle^\circ$ )	Mag.	Ang.( $\angle^\circ$ )
50	0.957	-20.2	0.968	-20.2
100	0.942	-39.5	0.954	-39.3
200	0.902	-74.0	0.911	-73.7
300	0.866	-102.8	0.871	-102.0
400	0.836	-126.1	0.840	-124.8
500	0.815	-145.4	0.818	-143.7
600	0.800	-161.8	0.801	-159.5
700	0.791	-176.1	0.790	-173.3
800	0.782	171.2	0.782	174.5
900	0.778	159.6	0.775	163.2
1000	0.772	148.6	0.769	152.8
1100	0.758	138.0	0.757	142.6
1200	0.763	128.8	0.758	133.9
1300	0.762	119.6	0.756	125.0
1400	0.761	110.7	0.752	116.5
1500	0.759	102.0	0.749	108.2
1600	0.756	93.8	0.747	100.3
1700	0.753	85.7	0.744	92.5
1800	0.753	77.6	0.741	84.7
1900	0.750	69.6	0.738	77.0
2000	0.747	61.8	0.734	69.5
2100	0.744	54.4	0.730	62.5
2200	0.744	46.6	0.730	55.0
2300	0.740	39.1	0.723	47.6
2400	0.739	31.8	0.720	40.5
2500	0.733	24.4	0.719	33.4
2600	0.729	17.3	0.711	26.3
2700	0.727	10.3	0.707	19.8
2800	0.722	2.9	0.701	12.5
2900	0.715	-4.2	0.695	5.6
3000	0.710	-11.3	0.690	-1.2

# NJG1506R

## APPLICATION CIRCUIT 1: Single control signal operation by using C-MOS inverter.

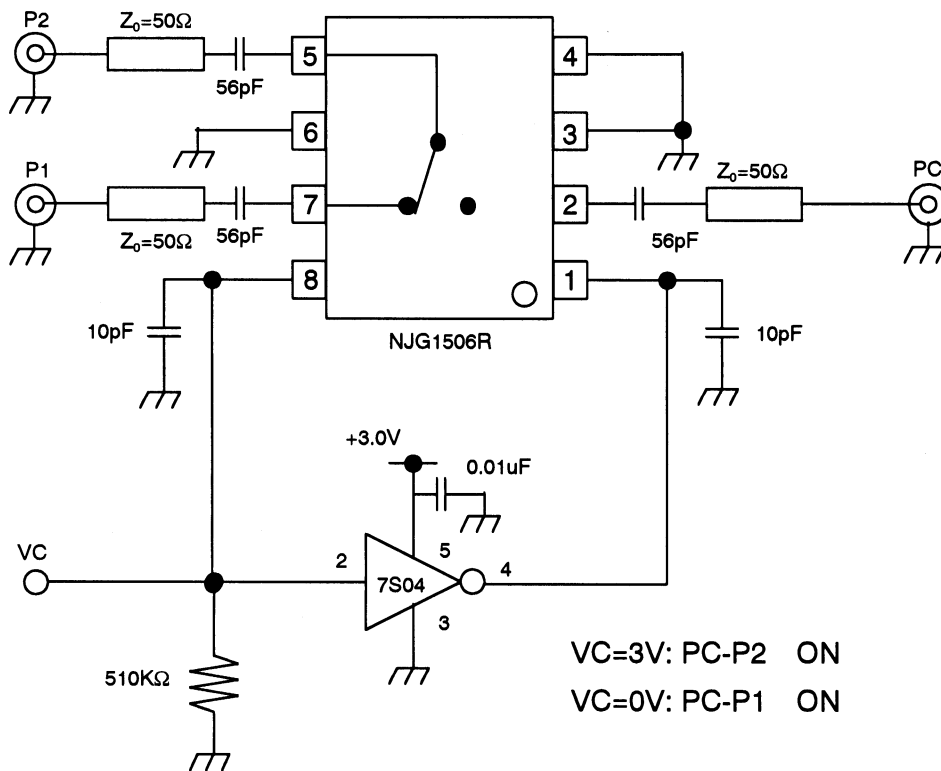

- [1] Please connect bypass capacitors to the supply terminals of the C-MOS inverter.
- [2] In order to stabilize input impedance of inverter, please pull down using 510KΩ resistor from the input terminal of the C-MOS inverter to the ground.

## APPLICATION CIRCUIT 2: Single control signal operation by using a transistor.

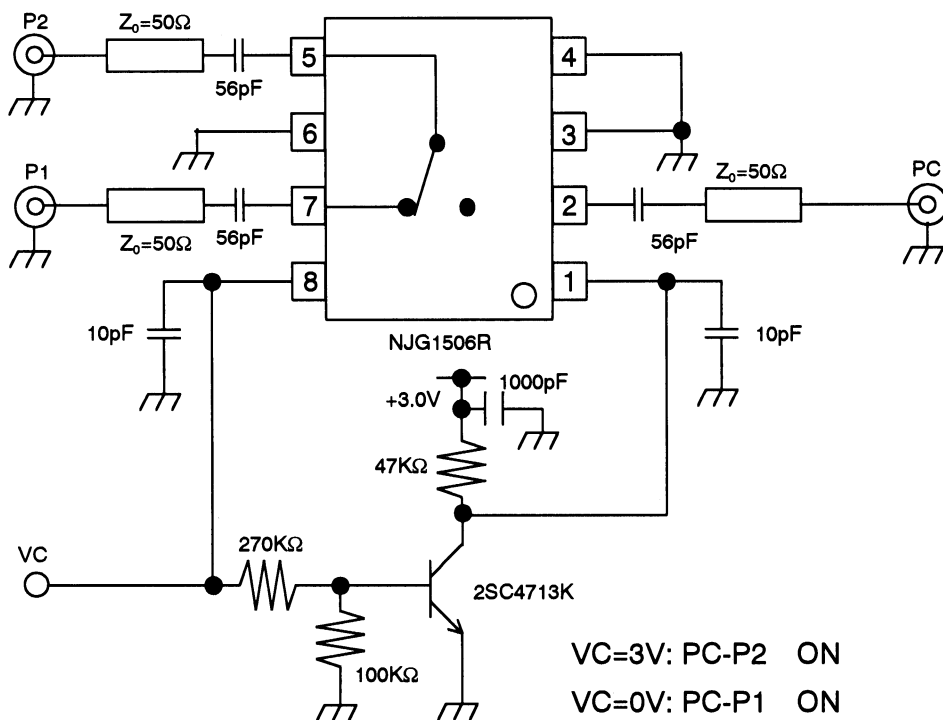

## ■TEST CIRCUIT

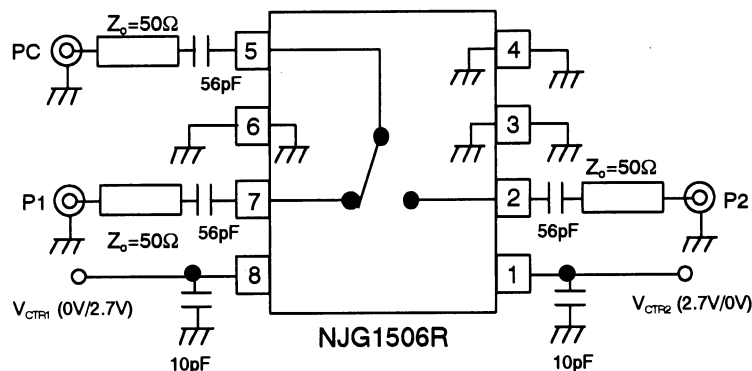

## ■RECOMMENDED PCB DESIGN

(TOP VIEW)

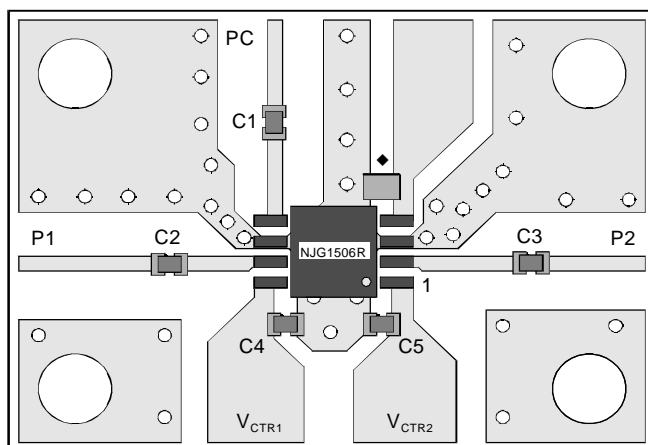

PCB SIZE=19.5x14.0mm

PCB: FR-4, t=0.2mm

CAPACITOR: size 1005

STRIPLINE WIDTH=0.5mm

C1~C3: 56pF

C4, C5: 10pF

◆: Please short between Pin4 and ground plane directly as close as possible.

## Precautions

- [1] External capacitors should be connected to the input and output RF terminals (P1, P2, PC) to block the DC current. The above example is a circuit at 900MHz. Please select the capacitor value suitable for actual frequency from 10pF to 1000pF.
- [2] Decoupling capacitors should be connected to the control terminals ( $V_{CTR1}$ ,  $V_{CTR2}$ ) as close as possible. The values of these capacitors should be selected from 5pF to 100pF range. Please consider that these values are very effective to switching time (Larger capacitor gives longer switching time).
- [3] In order to keep good isolation characteristics, the ground terminals (3, 4, 6pin) should be connected to the ground pattern with wider width as close as possible, and through-hole in the ground plane should also be placed as close as possible.

# NJG1506R

## ■PACKAGE OUTLINE (VSP8)

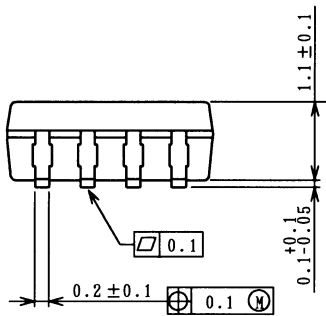
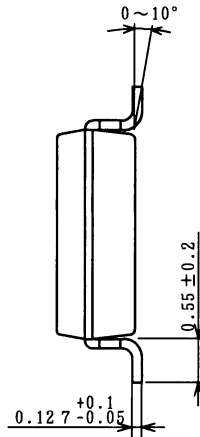
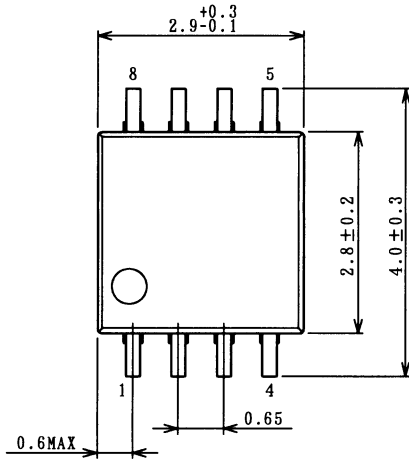

Lead material	: Copper
Lead surface finish	: Solder plating
Molding material	: Epoxy resin
UNIT	: mm
Weight	: 22mg

### Cautions on using this product

This product contains Gallium-Arsenide (GaAs) which is a harmful material.

- Do NOT eat or put into mouth.
- Do NOT dispose in fire or break up this product.
- Do NOT chemically make gas or powder with this product.
- To waste this product, please obey the relating law of your country.

This product may be damaged with electric static discharge (ESD) or spike voltage. Please handle with care to avoid these damages.

### [CAUTION]

The specifications on this databook are only given for information, without any guarantee as regards either mistakes or omissions. The application circuits in this databook are described only to show representative usages of the product and not intended for the guarantee or permission of any right including the industrial rights.