

## TDMA ANTENNA SWITCH GaAs MMIC

### ■GENERAL DESCRIPTION

NJG1515AVB2 is an antenna switch IC for a digital cellular phone of 800MHz and 1.5GHz band.

The parallel control signals of three bits connect T/R circuits to internal two antennas or external two antennas.

The termination ports with external matching circuits make low interference between diversity antennas.

NJG1515AVB2 features very low insertion loss and low current consumption in a very small SSOP20 package.

### ■PACKAGE OUTLINE

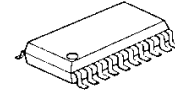

NJG1515AVB2

### ■FEATURES

- Low voltage operation                    -2.5V (Tx only) and +3.5V
- Low current consumption                10uA typ. @ $P_{in}=30\text{dBm}$  (Transmit)  
2uA typ. @ $P_{in}=10\text{dBm}$  (Receiving)
- Low insertion loss                        0.5dB typ. @(TX-ANT1, TX-EXT1)  $f=940\text{MHz}$ ,  $P_{in}=30\text{dBm}$   
0.6dB typ. @(TX-ANT1, TX-EXT1)  $f=1453\text{MHz}$ ,  $P_{in}=30\text{dBm}$
- Low Adjacent Channel Leakage Power   -63dBc typ. @ $V_{DD}=+3.5\text{V}$ ,  $V_{SS}=-2.5\text{V}$ ,  $f=940\text{MHz}$ ,  $P_{in}=30\text{dBm}$   
-64dBc typ. @ $V_{DD}=+3.5\text{V}$ ,  $V_{SS}=-2.5\text{V}$ ,  $f=1453\text{MHz}$ ,  $P_{in}=30\text{dBm}$
- Package                                      SSOP20-B2 (Mount Size: 6.4x5.0x1.25mm)

### ■PIN CONFIGURATION

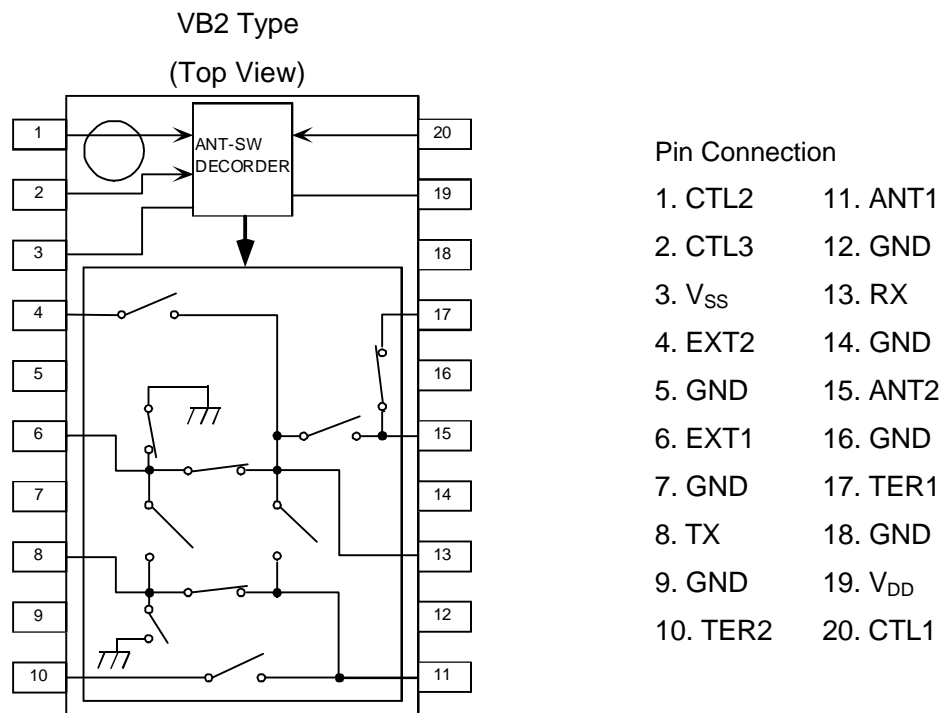

# NJG1515AVB2

## ■ABSOLUTE MAXIMUM RATINGS

(T<sub>a</sub>=25°C)

PARAMETER	SYMBOL	CONDITIONS	RATINGS	UNITS
Supply voltage 1	V <sub>DD</sub>	V <sub>DD</sub> Terminal	6.0	V
Supply voltage 2	V <sub>SS</sub>	V <sub>SS</sub> Terminal	-4.0	V
Control voltage	V <sub>CTR</sub>	CTL1, CTL2, CTL3 Each Terminals	6.0	V
Input power	P <sub>in</sub>	TX, ANT1, EXT1 Terminals	37	dBm
		RX, ANT2, EXT2 Terminals	28	dBm
Power dissipation	P <sub>D</sub>		600	mW
Operating temp.	T <sub>opr</sub>		-40~85	°C
Storage temp.	T <sub>stg</sub>		-55~125	°C

## ■ELECTRICAL CHARACTERISTICS 1 [DC CHARACTERISTICS]

Common conditions: T<sub>a</sub>=25°C, V<sub>DD</sub>=3.5V, V<sub>SS</sub>=-2.5V

TX, RX, ANT1, ANT2, EXT1, EXT2: terminated (50Ω)

TER1, TER2: connected to GND by 5pF capacitors

PARAMETER	SYMBOL	CONDITIONS	MIN	TYP	MAX	UNITS
Positive supply voltage	V <sub>DD</sub>	V <sub>DD</sub> Terminal	2.7	3.5	5.0	V
Negative supply voltage	V <sub>SS</sub>	V <sub>SS</sub> Terminal	-3.5	-2.5	-2.0	V
Current consumption 1	I <sub>DD1</sub>	V <sub>DD</sub> Terminal No RF Signal	-	2.0	5.0	uA
Current consumption 2	I <sub>SS1</sub>	V <sub>SS</sub> Terminal No RF Signal	-0.1	-	0	uA
Current consumption 3	I <sub>DD2</sub>	f=0.1~2GHz, P <sub>in</sub> =30dBm Transmitting state	-	10	30	uA
Current consumption 4	I <sub>SS2</sub>	f=0.1~2GHz, P <sub>in</sub> =30dBm Transmitting state	-30	-10	-	uA
Control voltage (H)	V <sub>CTL(H)</sub>	CTL1, CTL2, CTL3 terminals	2.0	3.0	V <sub>DD</sub>	V
Control voltage (L)	V <sub>CTL(L)</sub>	CTL1, CTL2, CTL3 terminals	0	0	0.6	V
Control current	I <sub>CTL</sub>	CTL1, CTL2, CTL3=V <sub>DD</sub> or CTL1, CTL2, CTL3=0V	-1.3	-	1.3	uA
Control terminal Input Impedance	R <sub>in</sub>	CTL1, CTL2, CTL3 each Terminal	4	-	-	MΩ

\* The voltage of this terminal should be supplied before or same time with other DC supplying terminals. (CTL1~3, V<sub>SS</sub>).

## ■ELECTRICAL CHARACTERISTICS 2 [800MHz TX Mode]

Common Conditions:  $f=960\text{MHz}$ ,  $T_a=25^\circ\text{C}$ ,  $V_{DD}=3.5\text{V}$ ,  $V_{SS}=-2.5\text{V}$

Tested on PCB circuit as shown below.

Insertion loss of each connectors, striplines, and capacitors are excluded.

TX, RX, ANT1, ANT2, EXT1 and EXT2 are terminated to  $50\Omega$ .

TER1 and TER2 are connected to GND through  $5\text{pF}$  capacitor.

PARAMETER	SYMBOL	CONDITION	MIN	TYP	MAX	UNITS
Frequency range 1	fin1		885	-	960	MHz
TX-ANT1 Insertion Loss	LOSS1	$P_{in}=30\text{dBm}$	-	0.5	0.65	dB
TX-EXT1 Insertion Loss	LOSS2	$P_{in}=30\text{dBm}$	-	0.5	0.65	dB
TX-RX Isolation	ISL1	$P_{in}=30\text{dBm}$ TX-ANT1, TX-EXT1 passing	24	29	-	dB
TX-ANT1 Isolation	ISL2	$P_{in}=30\text{dBm}$ TX-EXT1 passing	22	27	-	dB
TX-ANT2 Isolation	ISL3	$P_{in}=30\text{dBm}$ TX-ANT1, TX-EXT1 passing	33	38	-	dB
TX-EXT1 Isolation	ISL4	$P_{in}=30\text{dBm}$ TX-ANT1 passing	21	26	-	dB
TX-EXT2 Isolation	ISL5	$P_{in}=30\text{dBm}$ TX-ANT1, TX-EXT1 passing	32	37	-	dB
Pin at 0.5dB compression point 1	$P_{-0.5\text{dB}}(1)$	TX-ANT1, TX-EXT1 passing	33	34	-	dBm
Adjacent Channel Leakage Power 1	ACP1	PDC Standard, $\pm 50\text{kHz}$ offset $P_{in}=30\text{dBm}$ , Input Signal ACP=-64dBc @30dBm	-	-63	-60	dBc
Adjacent Channel Leakage Power 3	ACP2	PDC Standard, $\pm 100\text{kHz}$ offset $P_{in}=30\text{dBm}$ , Input Signal ACP=-76dBc @30dBm	-	-74	-70	dBc
2nd Harmonics 1	$2f_0(1)$	$P_{in}=30\text{dBm}$ , Input Signal 2nd Harmonics=-68dBc	-	-63	-60	dBc
3rd Harmonics 1	$3f_0(1)$	$P_{in}=30\text{dBm}$ , Input Signal 2nd Harmonics=-69dBc	-	-63	-60	dBc
VSWR1	VSWR1	TX-ANT1, TX-EXT1 passing	-	1.3	1.5	
Switching time	TD1	CTL1~3	-	120	500	nsec

# NJG1515AVB2

## ■ELECTRICAL CHARACTERISTICS 3 [800MHz Rx Mode]

Common Conditions:  $f=885\text{MHz}$ ,  $T_a=25^\circ\text{C}$ ,  $V_{DD}=3.5\text{V}$ ,  $V_{SS}=0\text{V}$

Tested on PCB circuit as shown below

Insertion loss of each connectors, striplines, and capacitors are excluded.

TX, RX, ANT1, ANT2, EXT1 and EXT2 are terminated to  $50\Omega$ .

TER1 and TER2 are connected to GND through  $5\text{pF}$  capacitor.

PARAMETER	SYMBOL	CONDITIONS	MIN	TYP	MAX	UNITS
Frequency range 2	fin2		810	-	885	MHz
RX-ANT1 Insertion Loss	LOSS3	$P_{in}=10\text{dBm}$	-	0.65	0.80	dB
RX-ANT2 Insertion Loss	LOSS4	$P_{in}=10\text{dBm}$	-	0.60	0.75	dB
RX-EXT1 Insertion Loss	LOSS5	$P_{in}=10\text{dBm}$	-	0.70	0.85	dB
RX-EXT2 Insertion Loss	LOSS6	$P_{in}=10\text{dBm}$	-	0.65	.80	dB
RX-ANT1 Isolation	ISL6	$P_{in}=10\text{dBm}$ , RX-ANT2, RX-EXT1, RX-EXT2 passing	21	24	-	dB
RX-ANT2 Isolation	ISL7	$P_{in}=10\text{dBm}$ , RX-ANT1, RX-EXT1, RX-EXT2 passing	22	25	-	dB
RX-EXT1 Isolation	ISL8	$P_{in}=10\text{dBm}$ , RX-ANT1, RX-ANT2, RX-EXT2 passing	22	25	-	dB
RX-EXT2 Isolation	ISL9	$P_{in}=10\text{dBm}$ , RX-ANT1, RX-ANT2, RX-EXT1 passing	20	23	-	dB
Pin at 1dB compression point 1	$P_{-1}(1)$	RX-ANT1, RX-ANT2, RX-EXT1, RX-EXT2 passing	20	26	-	dBm
VSWR 2	VSWR2	RX-ANT1, RX-ANT2, RX-EXT1, RX-EXT2 passing	-	1.4	1.6	
Switching time 2	TD2	CTL1~3	-	120	500	nsec

## ■ELECTRICAL CHARACTERISTICS 4 [1.5GHz Tx Mode]

Common Condition:  $f=1453\text{MHz}$ ,  $T_a=25^\circ\text{C}$ ,  $V_{DD}=3.5\text{V}$ ,  $V_{SS}=-2.5\text{V}$

Tested on PCB circuit as shown below

Insertion loss of each connectors, striplines, and capacitors are excluded.

TX, RX, ANT1, ANT2, EXT1 and EXT2 are terminated to  $50\Omega$ .

TER1 and TER2 are connected to GND through  $5\text{pF}$  capacitor.

PARAMETER	SYMBOL	CONDITIONS	MIN	TYP	MAX	UNITS
Frequency range 3	fin3		1429	-	1453	MHz
TX-ANT1 Insertion Loss	LOSS7	$P_{in}=30\text{dBm}$	-	0.55	0.70	dB
TX-EXT1 Insertion Loss	LOSS8	$P_{in}=30\text{dBm}$	-	0.65	0.80	dB
TX-RX Isolation	ISL10	$P_{in}=30\text{dBm}$ TX-ANT1, TX-EXT1 passing	28	33	-	dB
TX-ANT1 Isolation	ISL11	$P_{in}=30\text{dBm}$ TX-EXT1 passing	30	35	-	dB
TX-ANT2 Isolation	ISL12	$P_{in}=30\text{dBm}$ TX-ANT1, TX-EXT1 passing	30	35	-	dB
TX-EXT1 Isolation	ISL13	$P_{in}=30\text{dBm}$ TX-ANT1 passing	20	24	-	dB
TX-EXT2 Isolation	ISL14	$P_{in}=30\text{dBm}$ TX-ANT1, TX-EXT1 passing	35	40	-	dB
Pin at 0.5dB compression point 2	$P_{-0.5\text{dB}}(2)$	TX-ANT1, TX-EXT1 passing	33.5	35.5	-	dBm
Adjacent channel leakage power <sup>5</sup>	ACP3	PDC Standard, $\pm 50\text{kHz}$ offset $P_{in}=30\text{dBm}$ , Input Signal ACP=-67dBc @ 30dBm	-	-64	-60	dBc
Adjacent channel leakage power <sup>7</sup>	ACP4	PDC Standard, $\pm 100\text{kHz}$ offset $P_{in}=30\text{dBm}$ , Input Signal ACP=-76dBc @ 30dBm	-	-75	-70	dBc
2nd Harmonics <sup>2</sup>	$2f_0(2)$	Input Signal 2nd Harmonics =-68dBc, $P_{in}=30\text{dBm}$	-	-62	-60	dBc
3rd Harmonics <sup>2</sup>	$3f_0(2)$	Input Signal 2nd Harmonics =-69dBc, $P_{in}=30\text{dBm}$	-	-62	-60	dBc
VSWR3	VSWR3	TX-ANT1, TX-EXT1 passing	-	1.4	1.6	
Switching time <sup>3</sup>	TD3	CTL1~3	-	120	500	nsec

# NJG1515AVB2

## ■ELECTRICAL CHARACTERISTICS 5 [1.5GHz Rx Mode]

Common Condition:  $f=1501\text{MHz}$ ,  $T_a=25^\circ\text{C}$ ,  $V_{DD}=3.5\text{V}$ ,  $V_{SS}=0\text{V}$

Tested on PCB circuit as shown below

Insertion loss of each connectors, striplines, and capacitors are excluded.

TX, RX, ANT1, ANT2, EXT1 and EXT2 are terminated to  $50\Omega$ .

TER1 and TER2 are connected to GND through  $5\text{pF}$  capacitor.

PARAMETER	SYMBOL	CONDITIONS	MIN	TYP	MAX	UNITS
Frequency range 4	fin4		1477	-	1501	MHz
RX-ANT1 Insertion Loss	LOSS9	$P_{in}=10\text{dBm}$	-	0.80	0.95	dB
RX-ANT2 Insertion Loss	LOSS10	$P_{in}=10\text{dBm}$	-	0.80	0.95	dB
RX-EXT1 Insertion Loss	LOSS11	$P_{in}=10\text{dBm}$	-	1.00	1.15	dB
RX-EXT2 Insertion Loss	LOSS12	$P_{in}=10\text{dBm}$	-	0.80	0.95	dB
RX-ANT1 Isolation	ISL15	RX-ANT2, RX-EXT1, RX-EXT2 passing, $P_{in}=10\text{dBm}$	18	22	-	dB
RX-ANT2 Isolation	ISL16	RX-ANT1, RX-EXT1, RX-EXT2 passing, $P_{in}=10\text{dBm}$	19	24	-	dB
RX-EXT1 Isolation	ISL17	RX-ANT1, RX-ANT2, RX-EXT2 passing, $P_{in}=10\text{dBm}$	23	28	-	dB
RX-EXT2 Isolation	ISL18	RX-ANT1, RX-ANT2, RX-EXT1 passing, $P_{in}=10\text{dBm}$	17	22	-	dB
Pin at 1dB compression point <sup>2</sup>	$P_{-1}(2)$	RX-ANT1, RX-ANT2, RX-EXT1, RX-EXT2 passing	20	26	-	dBm
VSWR4	VSWR4	RX-ANT1, RX-ANT2, RX-EXT1, RX-EXT2 passing	-	1.4	1.6	
Switching time 4	TD4	CTL1~3	-	120	500	nsec

## ■ TERMINAL INFORMATION

PIN NO.	SYMBOL	DESCRIPTIONS
1	CTL2	High-impedance C-MOS input terminal. This terminal is set to High-Level by $2V \sim V_{DD}$ , and Low-Level by $+0.6V \sim 0V$ . In case of open or unstable level, connect this terminal by $100K\Omega$ resistor with GND terminal or $V_{DD}$ terminal.
2	CTL3	High-impedance C-MOS input terminal. This terminal is set to High-Level by $2V \sim V_{DD}$ , and Low-Level by $+0.6V \sim 0V$ . In case of open or unstable level, connect this terminal by $100K\Omega$ resistor with GND terminal or $V_{DD}$ terminal.
3	$V_{SS}$	Negative voltage supply terminal. The negative voltage ( $-3.5 \sim -2.0V$ ) have to be supplied on transmitting. Otherwise negative voltage of $-2.5 \sim 0V$ can be used or this terminal can be stayed open, because internal level of this terminal is automatically set to GND level on receiving. The bypass capacitor have to be connected with GND terminal for excellent RF performance.
4	EXT2	RF receiving port. An external capacitor of $56pF \sim 100pF$ is required to block DC voltage ( $V_{DD}$ ).
6	EXT1	RF transmitting/receiving port. An external capacitor of $56pF \sim 100pF$ is required to block DC voltage ( $V_{DD}$ ).
8	TX	RF transmitting port. An external capacitor of $56pF \sim 100pF$ is required to block DC voltage ( $V_{DD}$ ).
10	TER2	ANT1 termination port. The influence of ANT1 port to ANT2 port is suppressed by terminating this port by an appropriate termination. An external capacitor ( $5pF$ ) is required to block DC voltage ( $V_{DD}$ ).
11	ANT1	RF transmitting/receiving port. An external capacitor of $56pF \sim 100pF$ is required to block DC voltage ( $V_{DD}$ ).
13	RX	RF receiving port. An external capacitor of $56pF \sim 100pF$ is required to block DC voltage ( $V_{DD}$ ).
15	ANT2	RF receiving port. An external capacitor of $56pF \sim 100pF$ is required to block DC voltage ( $V_{DD}$ ).
17	TER1	ANT2 termination port. The influence of ANT2 port to ANT1 port is suppressed by terminating this port with appropriate termination. An external capacitor ( $5pF$ ) is required to block DC voltage ( $V_{DD}$ ).
19	$V_{DD}$	Positive voltage supply terminal. The positive voltage ( $2.7 \sim 5.0V$ ) have to be supplied. The bypass capacitor have to be connected with GND terminal for excellent RF performance.
20	CTL1	High-impedance C-MOS input terminal. This terminal is set to High-Level by $2V \sim V_{DD}$ , and Low-Level by $+0.6 \sim 0V$ . In case of open or unstable level, connect this terminal by $100k\Omega$ resistor with GND terminal or $V_{DD}$ terminal.
5,7,9,12, 14,16,18	GND	Ground terminal. Please connect this terminal with ground plane as close as possible for excellent RF performance.

# NJG1515AVB2

■ **TYPICAL CHARACTERISTICS** (Measured on the PCB evaluation circuit as shown below.  
All external circuit losses are included. Please refer the table of estimated losses.)

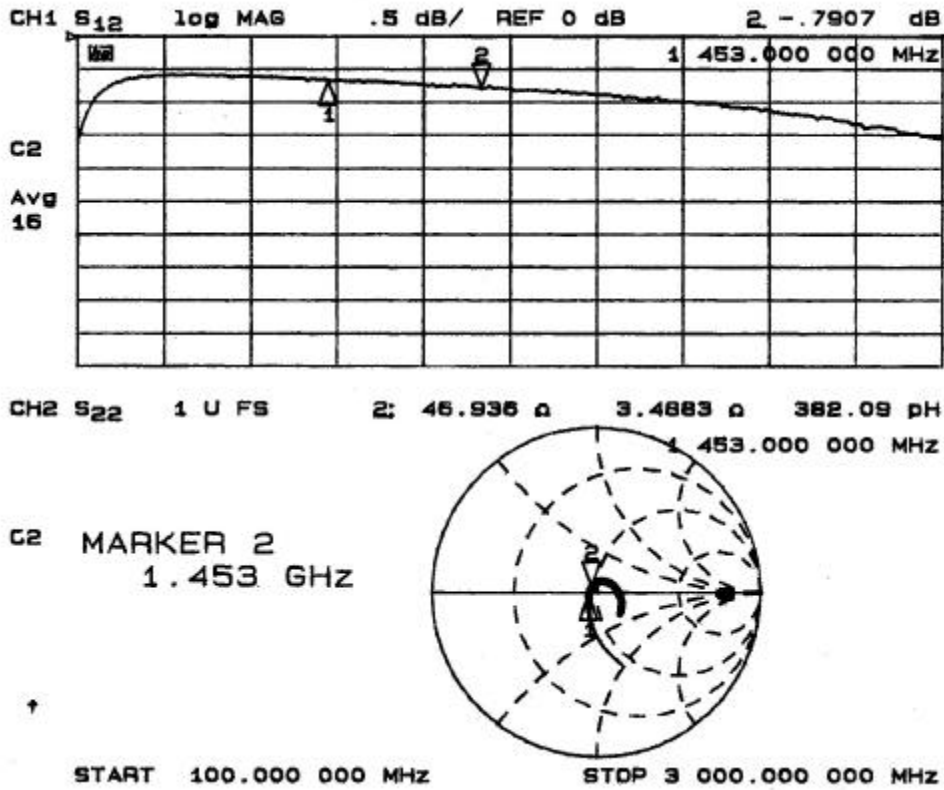

TX-ANT1 Insertion Loss, TX port reflection (Marker1: 940MHz, Marker 2: 1453MHz)

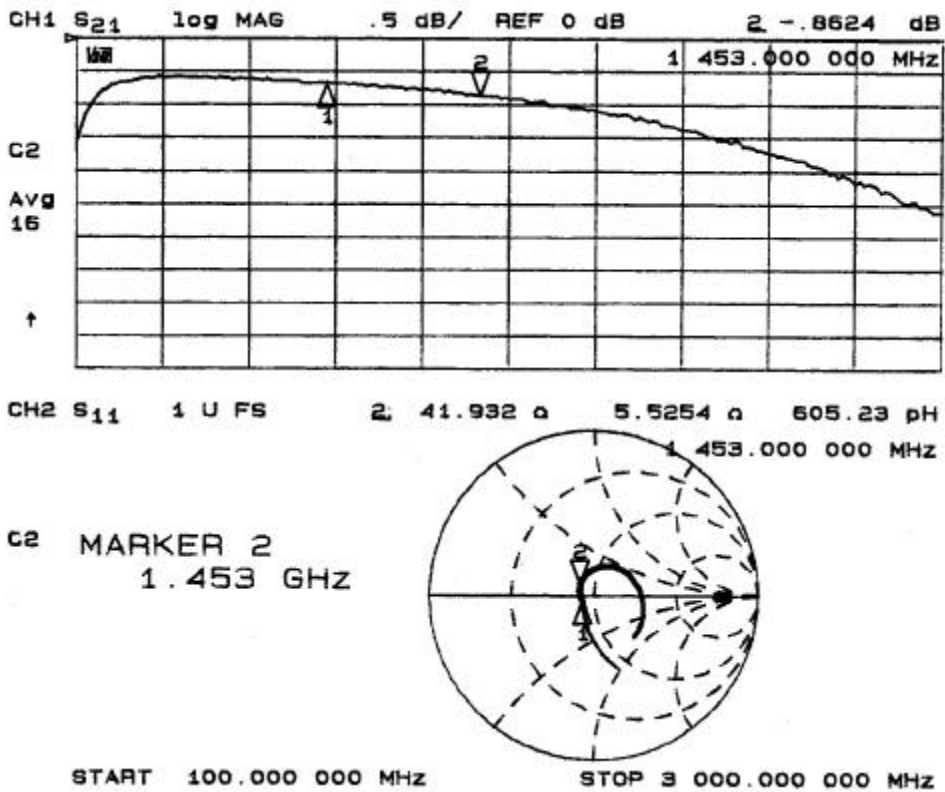

TX-EXT1 Insertion Loss, TX port reflection (Marker 1: 940MHz, Marker 2: 1453MHz)



## TYPICAL CHARACTERISTICS (Continued)

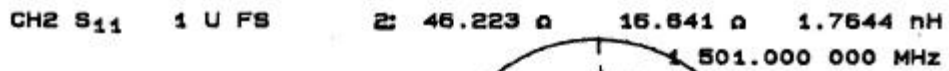
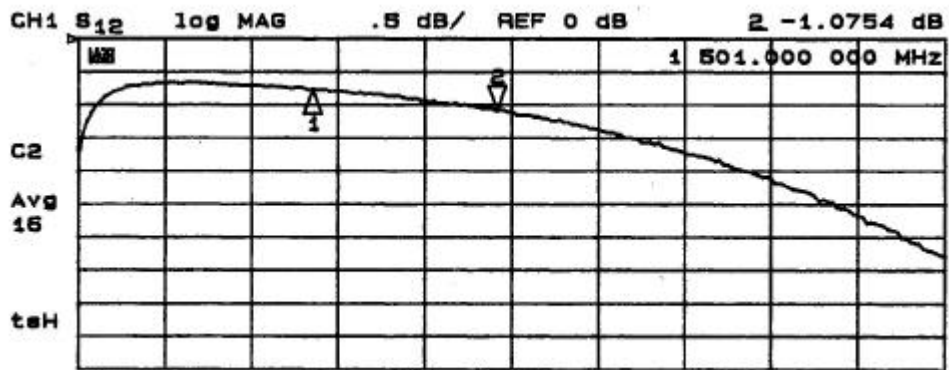

C2 MARKER 2  
1.501 GHz

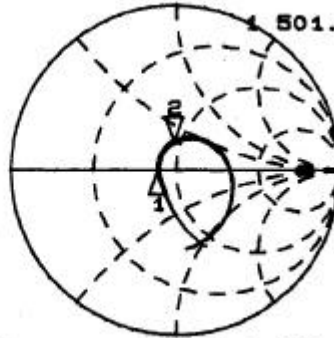

START 100.000 000 MHz

STOP 3 000.000 000 MHz

RX-ANT Insertion Loss, RX port reflection (Marker 1: 885MHz, Marker 2: 1501MHz)

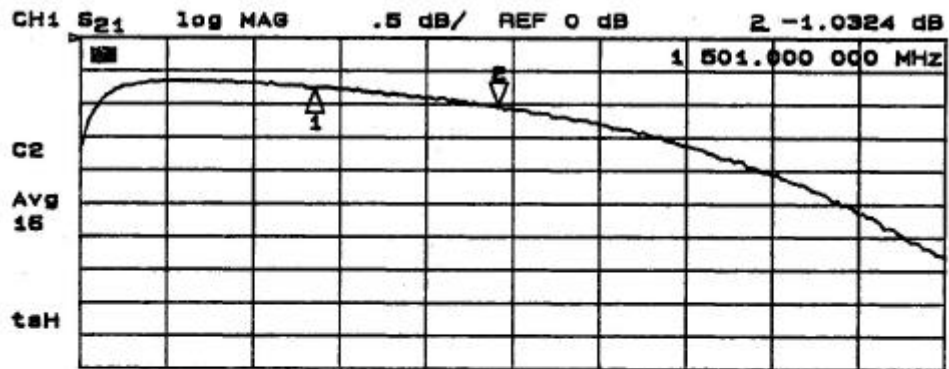

C2 MARKER 2  
1.501 GHz

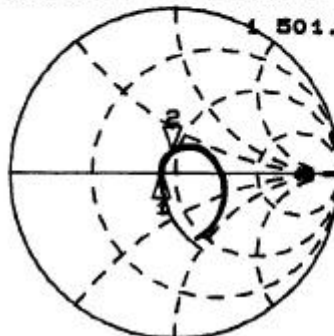

START 100.000 000 MHz

STOP 3 000.000 000 MHz

RX-ANT2 Insertion Loss, RX port reflection (Marker 1: 885MHz, Marker 2: 1501MHz)

# NJG1515AVB2

## TYPICAL CHARACTERISTICS (Continued)

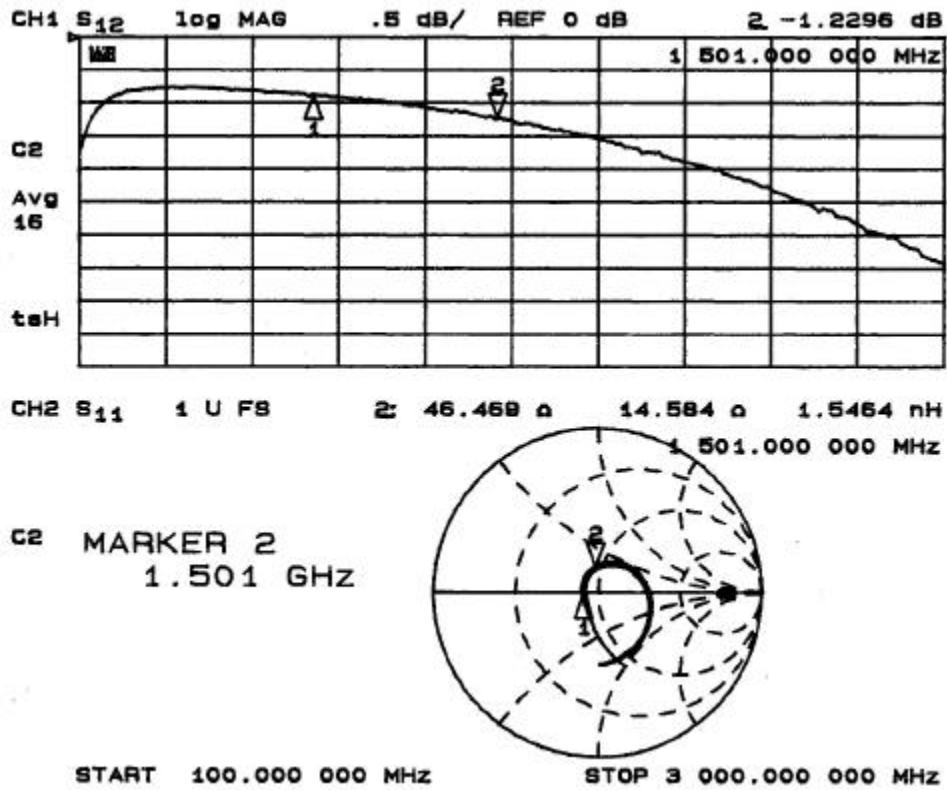

RX-EXT1 Insertion Loss, RX port reflection (Marker 1: 885MHz, Marker 2: 1501MHz)

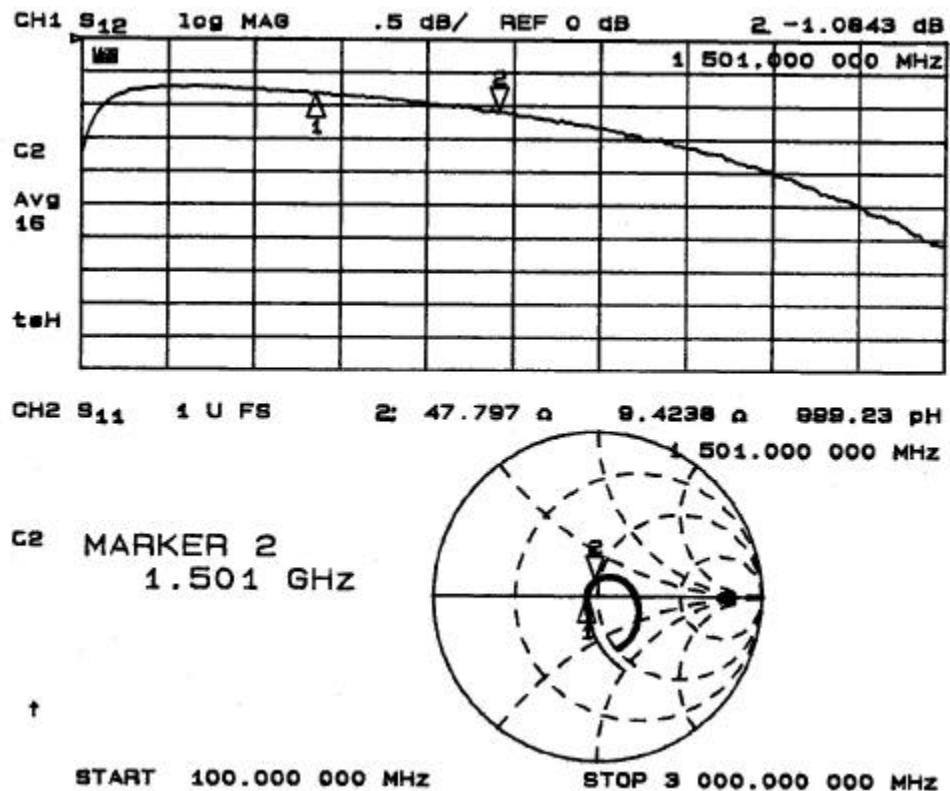

RX-EXT2 Insertion Loss, RX port reflection (Marker 1: 885MHz, Marker 2: 1501MHz)

■ TYPICAL CHARACTERISTICS (800MHz Band: Measured on the PCB evaluation circuit)

**Input Power vs. Output Power,  $I_{DD}$**

(Tx-Ant1,  $f=940\text{MHz}$ ,  $V_{DD}=3.5\text{V}$ ,  $V_{SS}=-2.5\text{V}$ )

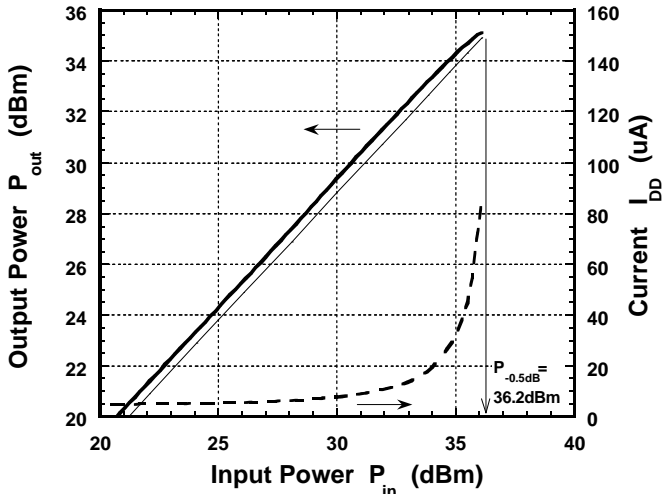

**Input Power vs. Output Power,  $I_{DD}$**

(Rx-Ant1,  $f=885\text{MHz}$ ,  $V_{DD}=3.5\text{V}$ ,  $V_{SS}=0\text{V}$ )

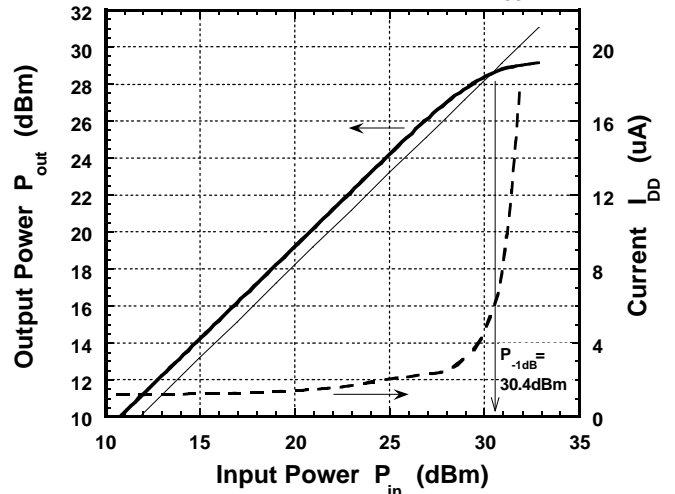

**Loss vs. Ambient Temperature vs.  $V_{DD}$**

(Tx-Ant1,  $f=940\text{MHz}$ ,  $V_{SS}=-2.5\text{V}$ )

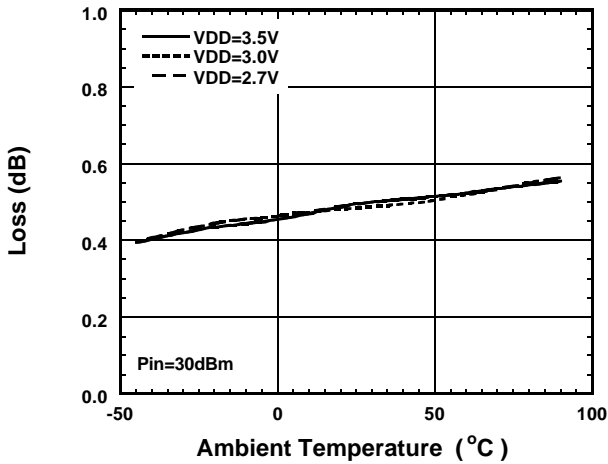

**Loss vs. Ambient Temperature vs.  $V_{DD}$**

(Tx-Ext1,  $f=940\text{MHz}$ ,  $V_{SS}=-2.5\text{V}$ )

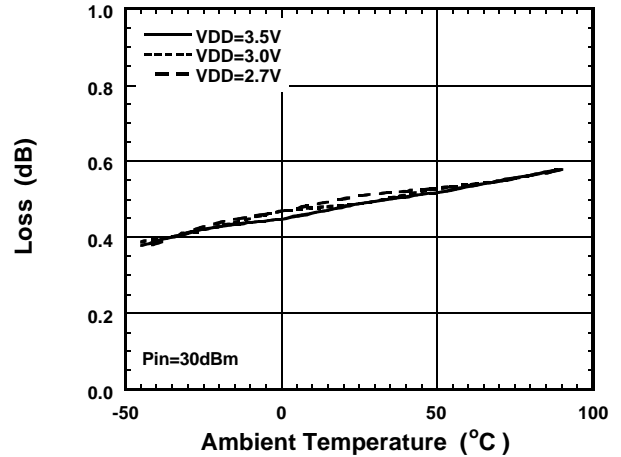

**$P_{-0.5dB}$  vs. Ambient Temperature vs.  $V_{DD}$**

(Tx-Ant1,  $f=940\text{MHz}$ ,  $V_{SS}=-2.5\text{V}$ )

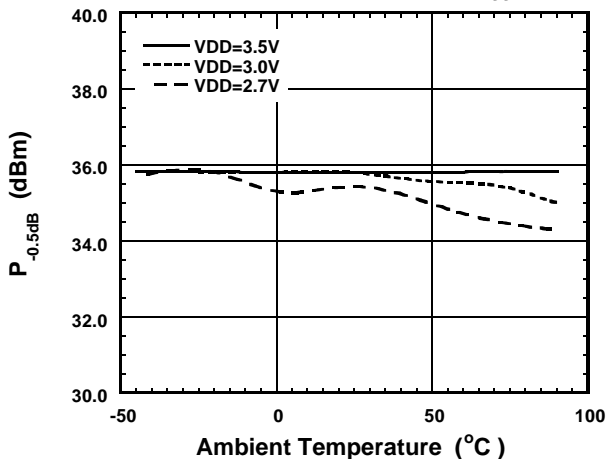

**ACP(+50kHz) vs. Ambient Temperature vs.  $V_{DD}$**

(Tx-Ant1,  $f=940\text{MHz}$ ,  $V_{SS}=-2.5\text{V}$ )

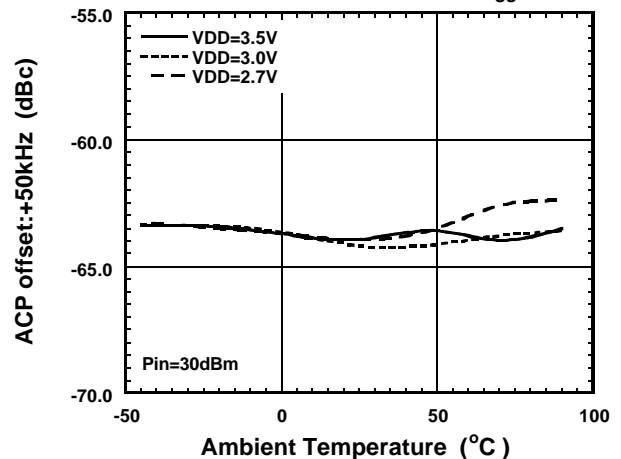

# NJG1515AVB2

■ TYPICAL CHARACTERISTICS (800MHz Band: Measured on the PCB evaluation circuit)

Loss vs. Ambient Temperature vs.  $V_{DD}$

(Rx-Ant1,  $f=885\text{MHz}$ ,  $V_{SS}=0\text{V}$ )

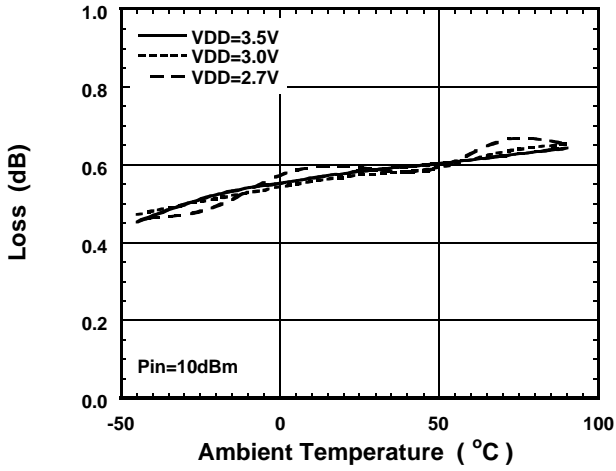

Loss vs. Ambient Temperature vs.  $V_{DD}$

(Rx-Ant2,  $f=885\text{MHz}$ ,  $V_{SS}=0\text{V}$ )

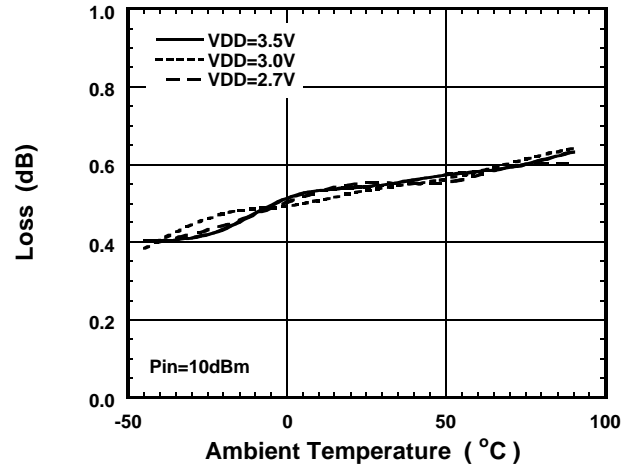

Loss vs. Ambient Temperature vs.  $V_{DD}$

(Rx-Ext1,  $f=885\text{MHz}$ ,  $V_{SS}=0\text{V}$ )

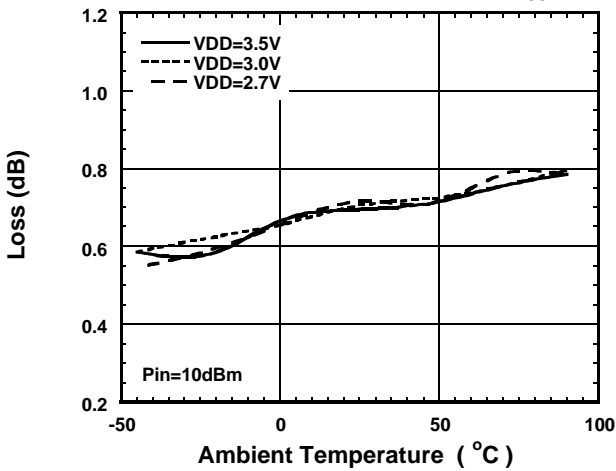

Loss vs. Ambient Temperature vs.  $V_{DD}$

(Rx-Ext2,  $f=885\text{MHz}$ ,  $V_{SS}=0\text{V}$ )

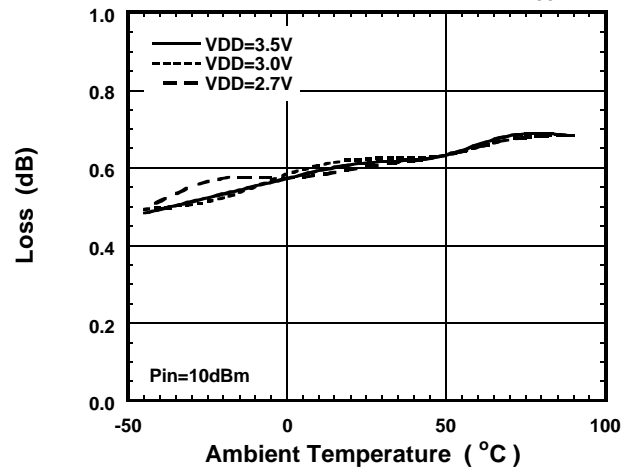

## TYPICAL CHARACTERISTICS (1.5GHz Band: Measured on the PCB evaluation circuit)

### Input Power vs. Output Power, $I_{DD}$

(Tx-Ant1,  $f=1453\text{MHz}$ ,  $V_{DD}=3.5\text{V}$ ,  $V_{SS}=-2.5\text{V}$ )

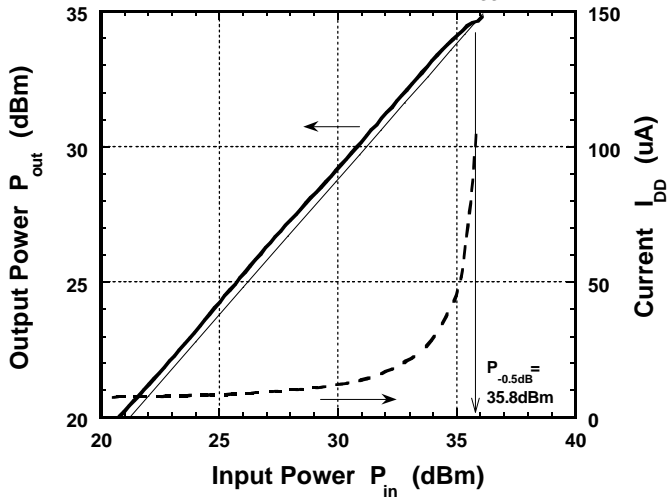

### Input Power vs. Output Power, $I_{DD}$

(Rx-Ant1,  $f=1501\text{MHz}$ ,  $V_{DD}=3.5\text{V}$ ,  $V_{SS}=0\text{V}$ )

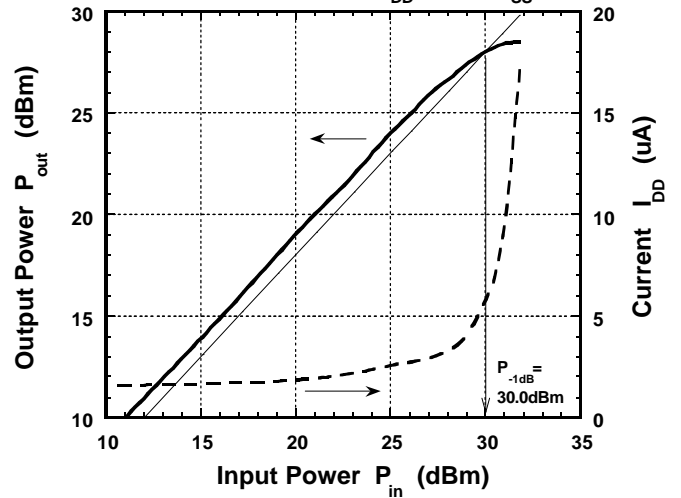

### Loss vs. Ambient Temperature vs. $V_{DD}$

(Tx-Ant1,  $f=1453\text{MHz}$ ,  $V_{SS}=-2.5\text{V}$ )

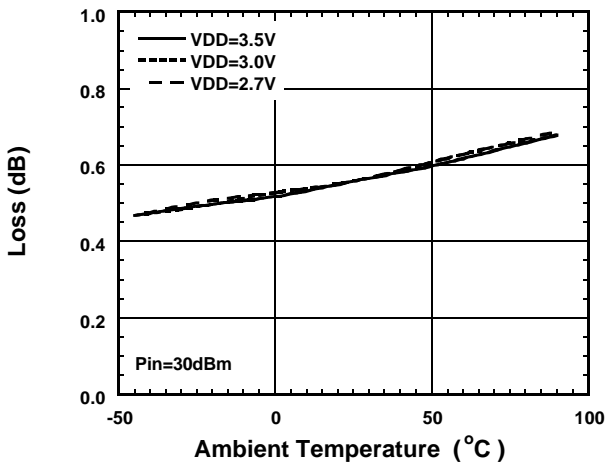

### Loss vs. Ambient Temperature vs. $V_{DD}$

(Tx-Ext1,  $f=1453\text{MHz}$ ,  $V_{SS}=-2.5\text{V}$ )

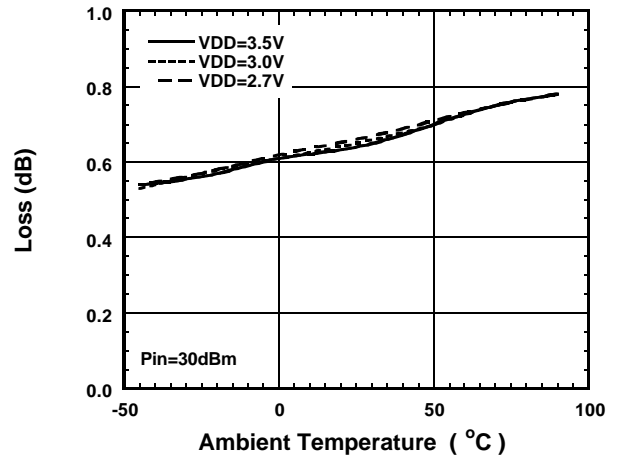

### $P_{-0.5dB}$ vs. Ambient Temperature vs. $V_{DD}$

(Tx-Ant1,  $f=1453\text{MHz}$ ,  $V_{SS}=-2.5\text{V}$ )

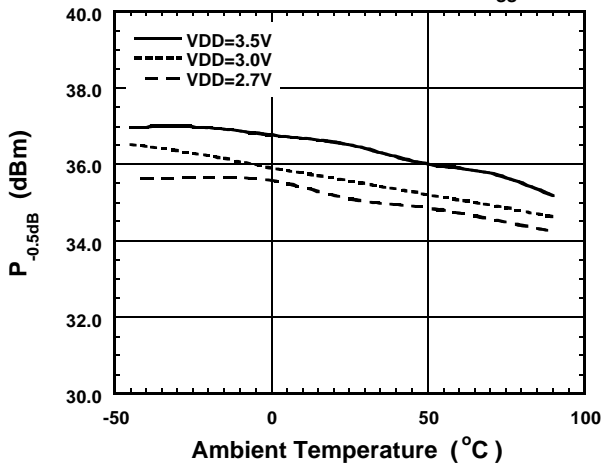

### ACP(+50kHz) vs. Ambient Temperature vs. $V_{DD}$

(Tx-Ant1,  $f=1453\text{MHz}$ ,  $V_{SS}=-2.5\text{V}$ )

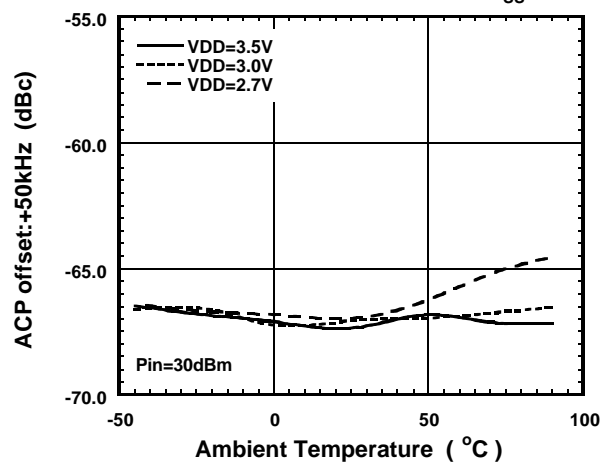

# NJG1515AVB2

■ TYPICAL CHARACTERISTICS (1.5GHz Band: Measured on the PCB evaluation circuit)

Loss vs. Ambient Temperature vs.  $V_{DD}$   
(Rx-Ant1,  $f=1501\text{MHz}$ ,  $V_{SS}=0\text{V}$ )

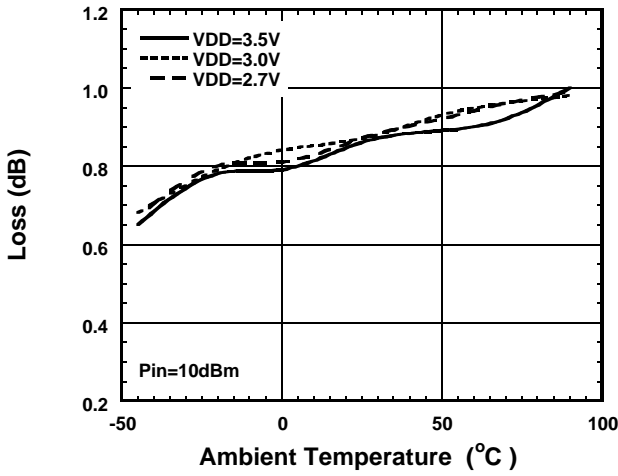

Loss vs. Ambient Temperature vs.  $V_{DD}$   
(Rx-Ant2,  $f=1501\text{MHz}$ ,  $V_{SS}=0\text{V}$ )

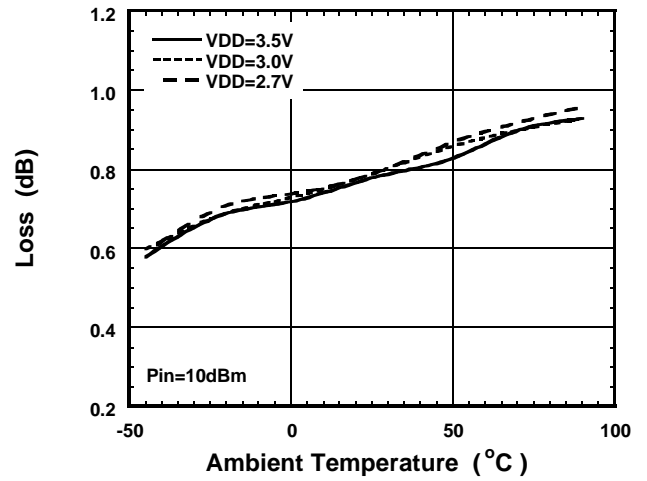

Loss vs. Ambient Temperature vs.  $V_{DD}$   
(Rx-Ext1,  $f=1501\text{MHz}$ ,  $V_{SS}=0\text{V}$ )

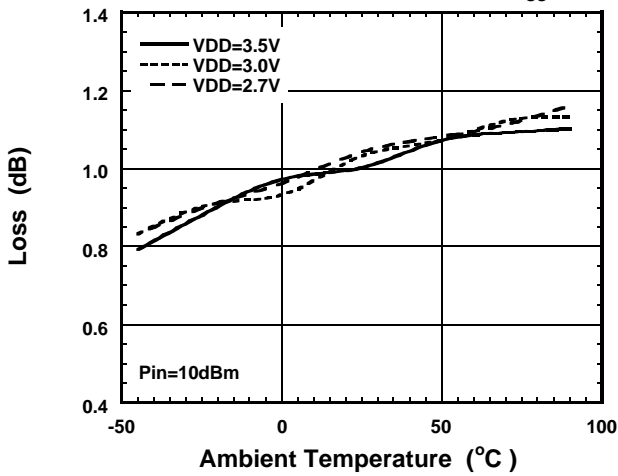

Loss vs. Ambient Temperature vs.  $V_{DD}$   
(Rx-Ext2,  $f=1501\text{MHz}$ ,  $V_{SS}=0\text{V}$ )

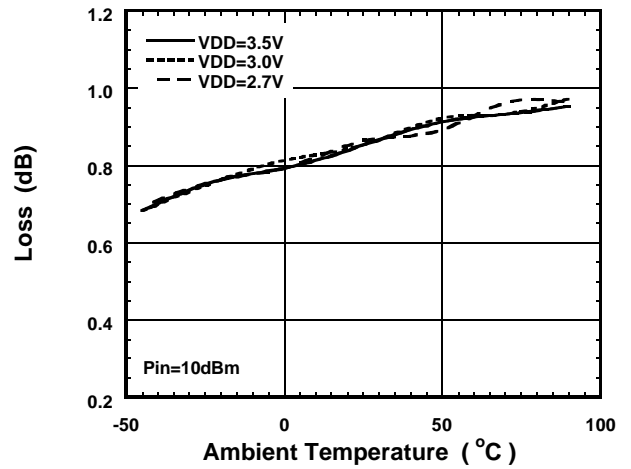

## TRUTH TABLE

"H"= $V_{CTL(H)}$ , "L"= $V_{CTL(L)}$ , "X"=H or L

ROUTE	CONTROL INPUT			CONTROL OUTPUT								
	RX/TX	Diversity	IN/OUT	SW1	SW2	SW3	SW4	SW5	SW6	SW7	SW8	SW9
	CTL1	CTL2	CTL3									
TX-ANT1	H	X	H	OFF	OFF	OFF	ON	ON	OFF	OFF	OFF	ON
TX-EXT1	H	X	L	OFF	OFF	ON	OFF	ON	ON	ON	OFF	OFF
RX-ANT1	L	L	H	OFF	OFF	ON	OFF	ON	OFF	ON	ON	ON
RX-ANT2	L	H	H	ON	OFF	OFF	OFF	OFF	ON	ON	ON	ON
RX-EXT1	L	L	L	OFF	OFF	OFF	ON	ON	ON	OFF	ON	OFF
RX-EXT2	L	H	L	OFF	ON	OFF	OFF	ON	ON	ON	ON	ON

## PIN CONFIGURATION (Top View)

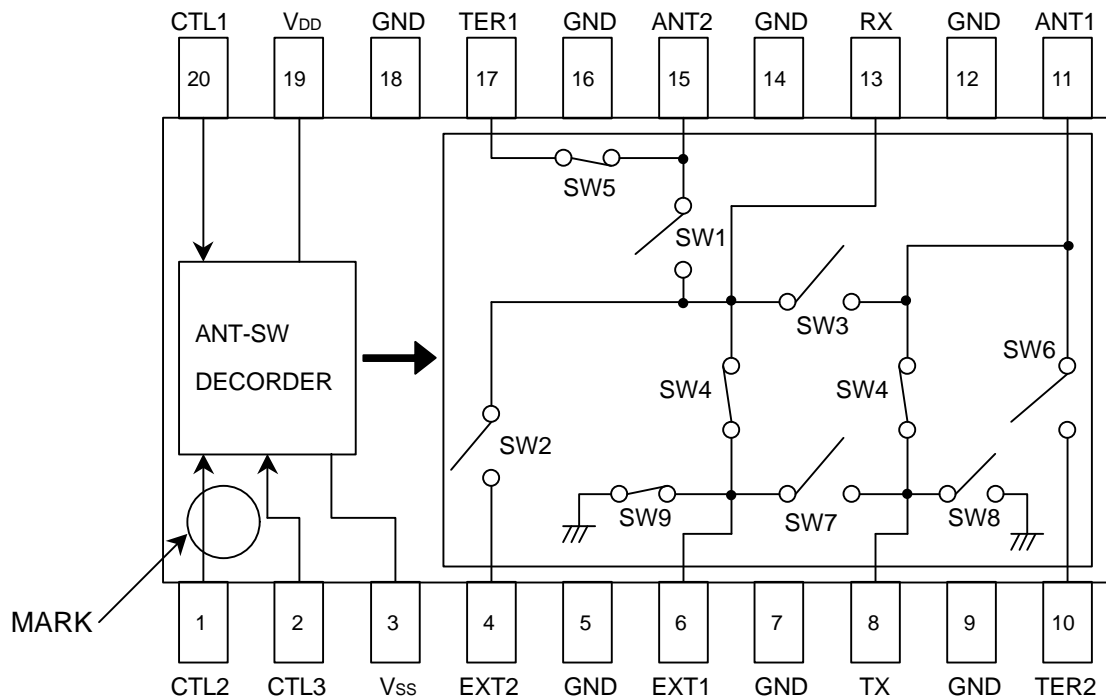

# NJG1515AVB2

## RECOMMENDED CIRCUIT (TX-ANT1 passing)

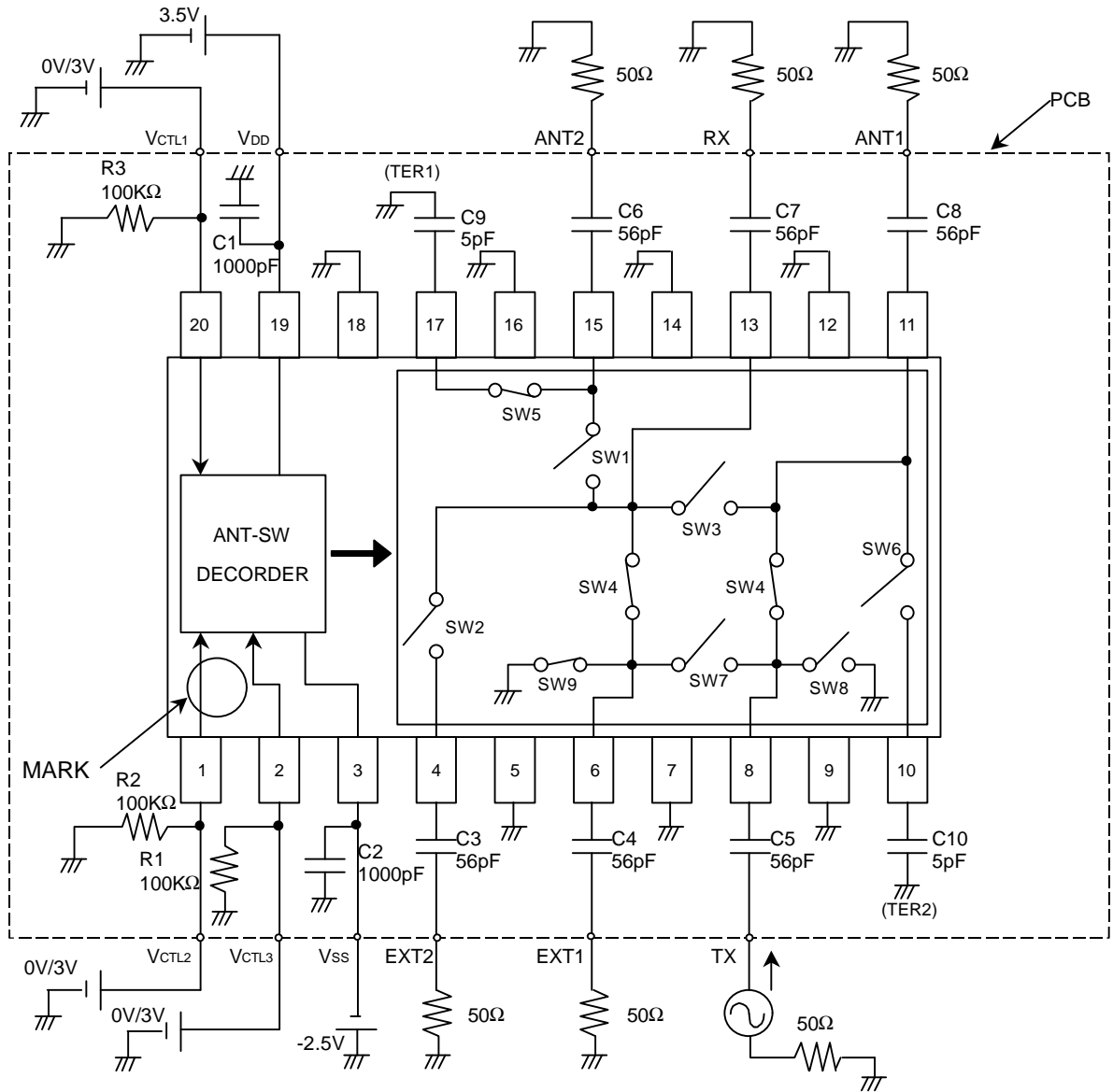



## RECOMMENDED PCB DESIGN

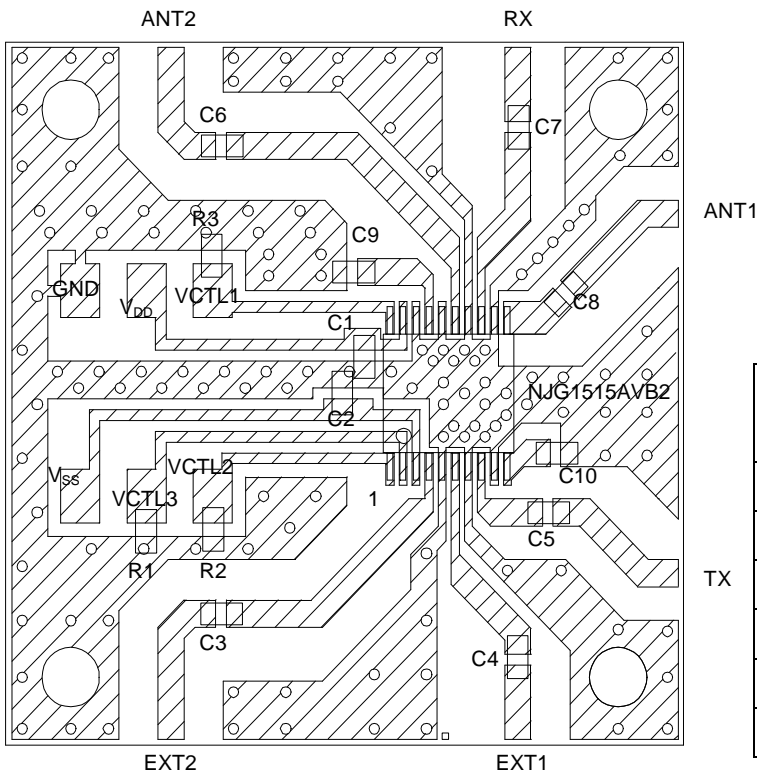

PCB: FR-4,  $t = 0.5\text{mm}$

Stripline width: 1mm

**Board total Loss  
(Capacitor, Connector and PCB)**

Pass route	800MHz Band (dB)	1.5GHzBand (dB)
TX-ANT1	0.17	0.21
TX-EXT1	0.18	0.21
RX-ANT1	0.17	0.23
RX-ANT2	0.19	0.25
RX-EXT1	0.18	0.24
RX-EXT2	0.19	0.25

## PARTS LIST

PART ID	VALUE	COMMENT
R1~R3	100K $\Omega$	TAMA Electronics (CRG16G)
C1, C2	1000pF	MURATA (GRM36)
C3~C8	56pF	MURATA (GRM36)
C9, C10	5pF	MURATA (GRM36)

## PRECAUTIONS

- [1] The bypass capacitors should be connected to the  $V_{DD}$ ,  $V_{SS}$  terminals as close as possible respectively.
- [2] For good RF performance, the ground terminals should be directly connected to the ground patterns and through-holes as close as possible using relatively wide pattern.

# NJG1515AVB2

## PACKAGE OUTLINE (SSOP20-B2)

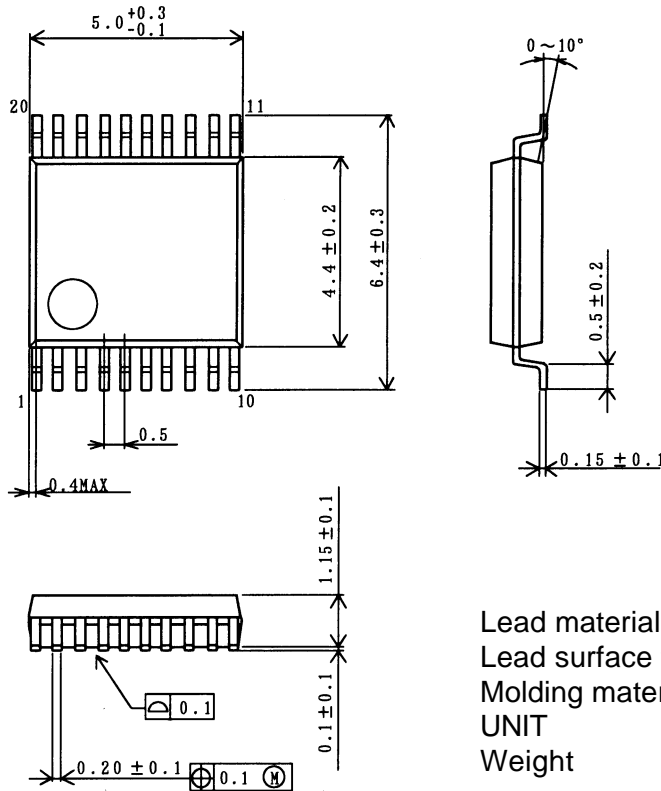

Lead material	: Copper
Lead surface finish	: Solder plating
Molding material	: Epoxy resin
UNIT	: mm
Weight	: 66mg

### Cautions on using this product

This product contains Gallium-Arsenide (GaAs) which is a harmful material.

- Do NOT eat or put into mouth.
- Do NOT dispose in fire or break up this product.
- Do NOT chemically make gas or powder with this product.
- To waste this product, please obey the relating law of your country.

### [CAUTION]

The specifications on this databook are only given for information, without any guarantee as regards either mistakes or omissions. The application circuits in this databook are described only to show representative usages of the product and not intended for the guarantee or permission of any right including the industrial rights.

This product may be damaged with electric static discharge (ESD) or spike voltage. Please handle with care to avoid these damages.