

SPDT SWITCH GaAs MMIC

■GENERAL DESCRIPTION

NJG1509F is a SPDT switch GaAs MMIC which features low loss, high isolation and low operating voltage, and ideally suitable for the T/R switch of digital wireless phone handsets.

This switch is operated in the wide frequency range from 50MHz to 3GHz at low operating voltage from +2.5V with very small MTP6 package.

■PACKAGE OUTLINE

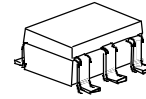

NJG1509F

■FEATURES

- Single and low positive control voltage +2.5V~+5.5V
- Low insertion loss 0.5dB typ. @f=2GHz, $P_{in}=22\text{dBm}$.
- Passing power 27dBm max. @f=2GHz $V_{CTL}=3.0\text{V}$
- High Isolation 25dB typ. @f=2GHz, $P_{in}=22\text{dBm}$
- Low control current 5uA typ. @f=0.05~2.5GHz, $P_{in}=22\text{dBm}$
- Package MTP6 (Mount Size: 2.8x2.9x1.2mm)

■PIN CONFIGURATION

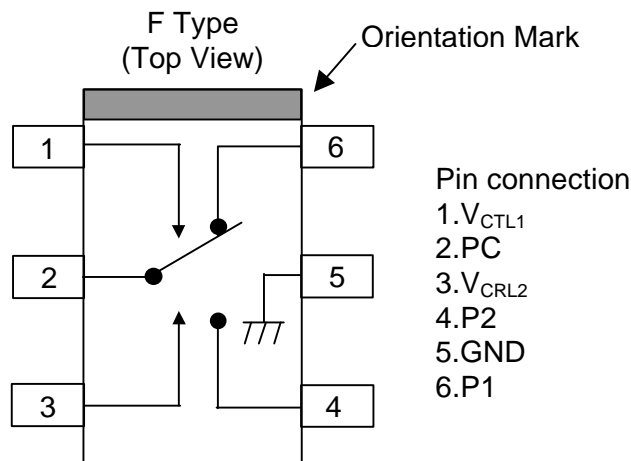

■TRUTH TABLE

“H”= V_{CTR} (H), “L”= V_{CTR} (L)

V_{CTL1}	H	L	L	H
V_{CTL2}	L	H	L	H
P1-PC	OFF	ON	Loss =15dB P_1 Return Loss =-3dB	Loss =16dB P_1 Return Loss =-2dB
P2-PC	ON	OFF	Loss =15dB P_2 Return Loss =-3dB	Loss =16dB P_2 Return Loss =-2dB

Note) The values of “Loss” and “Return Loss” are typical values.

NJG1509F

■ABSOLUTE MAXIMUM RATINGS

(T_a=25°C)

PARAMETER	SYMBOL	RATINGS	UNITS
Input Power	P _{in}	31	dBm
Control Voltage	V _{CTL}	6	V
Power Dissipation	P _D	300	mW
Operating Temp.	T _{opr}	-30~+85	°C
Storage Temp.	T _{stg}	-40~+150	°C

■ELECTRICAL CHARACTERISTICS

(V_{CTL(L)}=0V, V_{CTL(H)}=2.7V, Z_S=Z_O=50Ω, T_a=25°C)

PARAMETER	SYMBOL	CONDITIONS	MIN	TYP	MAX	UNITS
Control voltage (L)	V _{CTL(L)}	f=0.05~2.5GHz, P _{in} =10dBm	-0.2	0	0.2	V
Control voltage (H)	V _{CTL(H)}	f=0.05~2.5GHz, P _{in} =10dBm	2.5	2.7	5.5	V
Control current	I _{CTL}	f=0.05~2.5GHz, P _{in} =10dBm	-	5.0	8.0	uA
Insertion loss 1	LOSS1	f=1GHz, P _{in} =22dBm	-	0.4	0.7	dB
Insertion loss 2	LOSS2	f=2GHz, P _{in} =22dBm	-	0.5	0.8	dB
Isolation 1 (PC-P1, PC-P2, P1-P2)	ISL1	f=1GHz, P _{in} =22dBm	23	28	-	dB
Isolation 2 (PC-P1, PC-P2, P1-P2)	ISL2	f=2GHz, P _{in} =22dBm	20	25	-	dB
Pin at 1dB compression point 1	P _{-1dB1}	f=2GHz	26	28	-	dBm
Pin at 1dB compression point 2	P _{-1dB2}	V _{CTL(H)} =3.0V, f=2GHz	27	30	-	dBm
VSWR (PC, P1, P2)	VSWR	f=0.05~2.5GHz, ON State	-	1.3	1.6	
Switching time	T _{SW}	f=0.05~2.5GHz	-	15	-	ns

■ TYPICAL CHARACTERISTICS

(PC-P1) Insertion loss vs. Frequency
($V_{CTR}=0V/2.7V$, $P_{in}=22dBm$)

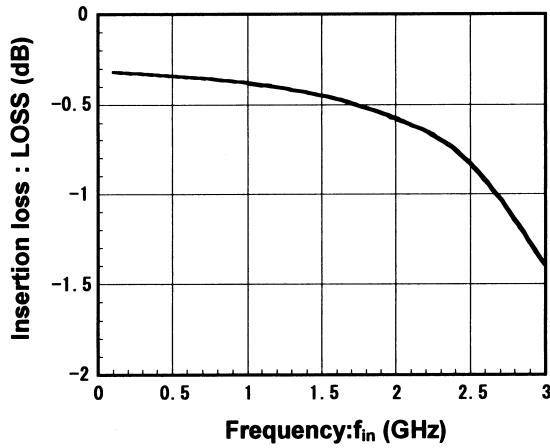

(PC-P2) Insertion loss vs. Frequency
($V_{CTR}=0V/2.7V$, $P_{in}=22dBm$)

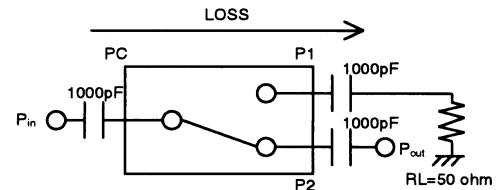
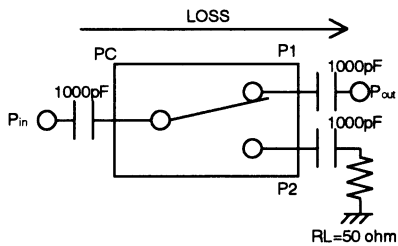
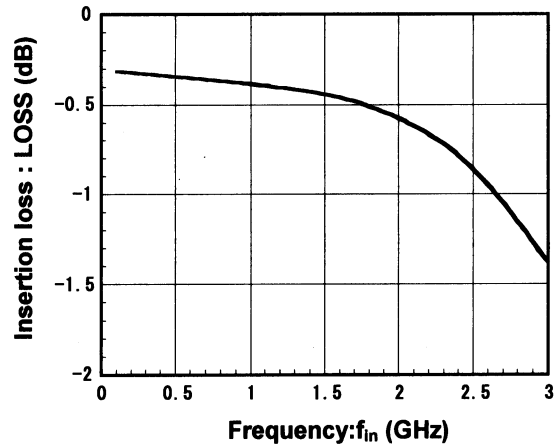

(PC-P1) Isolation vs. Frequency
($V_{CTR}=0V/2.7V$, $P_{in}=22dBm$)

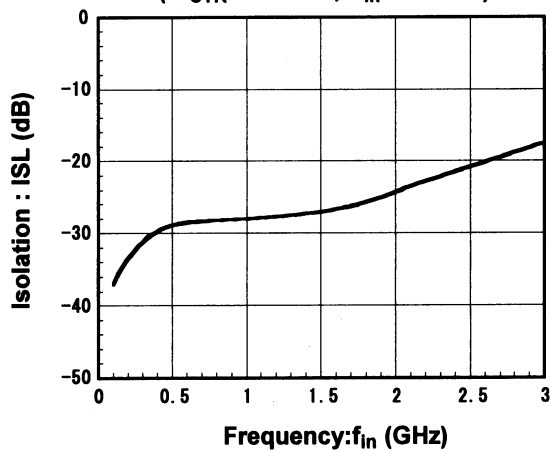

(PC-P2) Isolation vs. Frequency
($V_{CTR}=0V/2.7V$, $P_{in}=22dBm$)

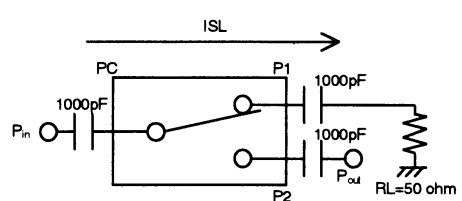
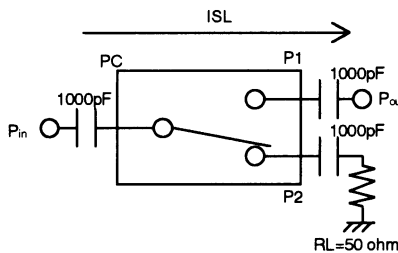
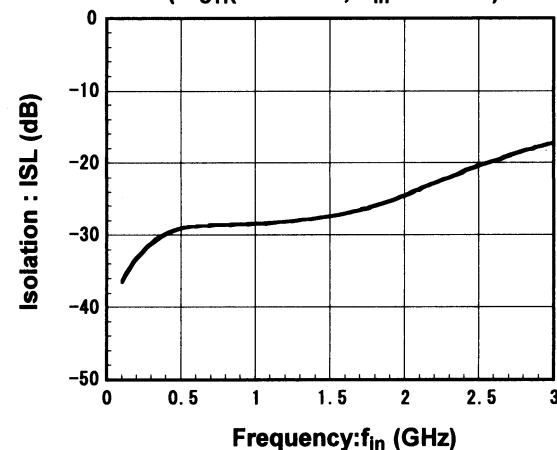

■ TYPICAL CHARACTERISTICS

P1-PC(ON)V.S.W.R vs. Frequency
 ($V_{CTR}=0V/2.7V$, $P_{in}=0dBm$)

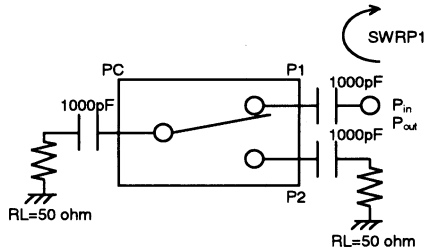
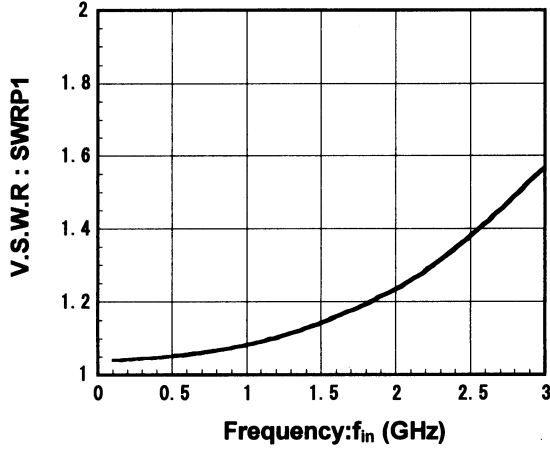

P2-PC(ON)V.S.W.R vs. Frequency
 ($V_{CTR}=0V/2.7V$, $P_{in}=0dBm$)

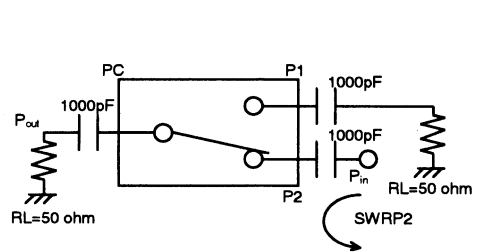
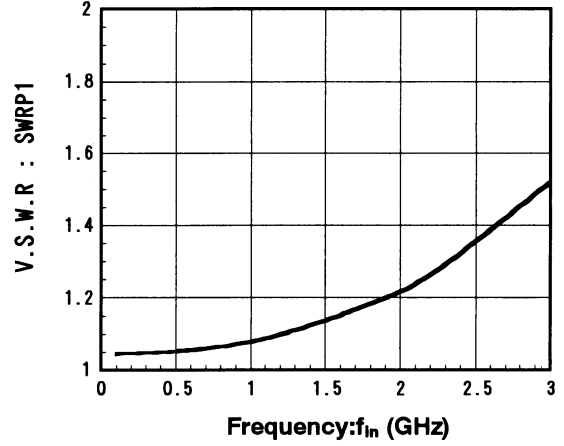

PC-P1(ON)V.S.W.R vs. Frequency
 ($V_{CTR}=0V/2.7V$, $P_{in}=0dBm$)

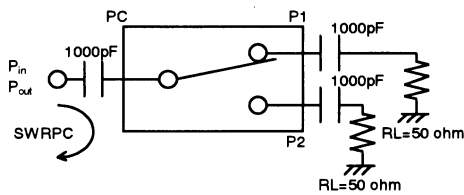
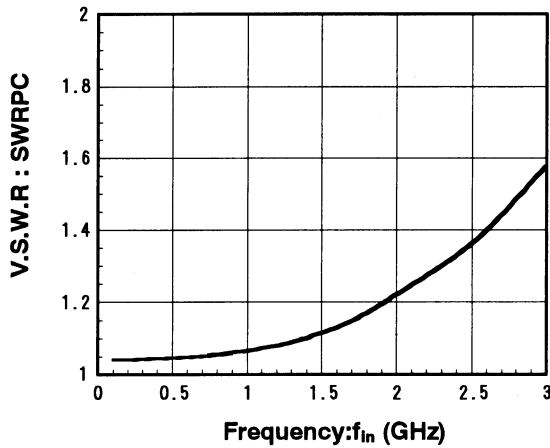

■ TYPICAL CHARACTERISTICS

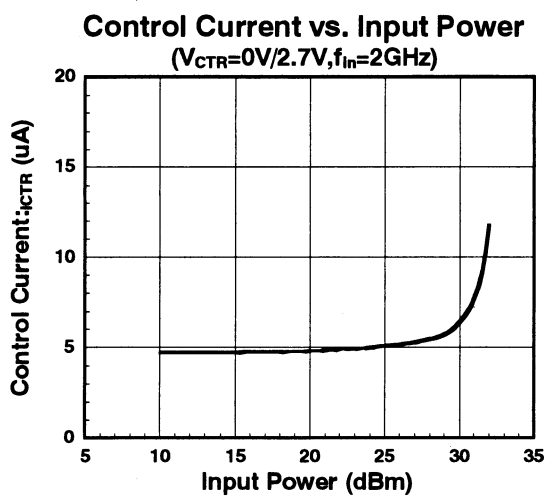
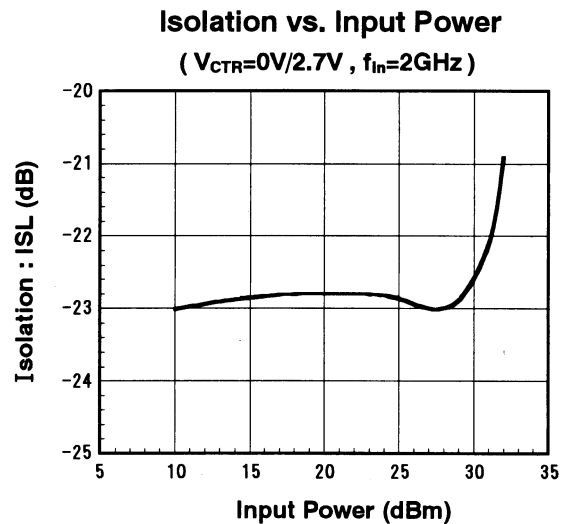
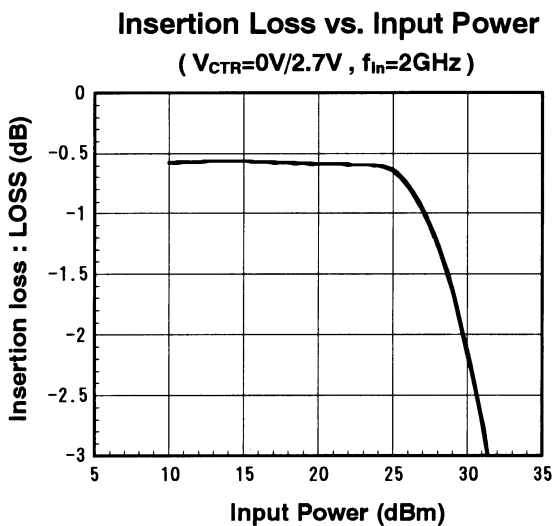
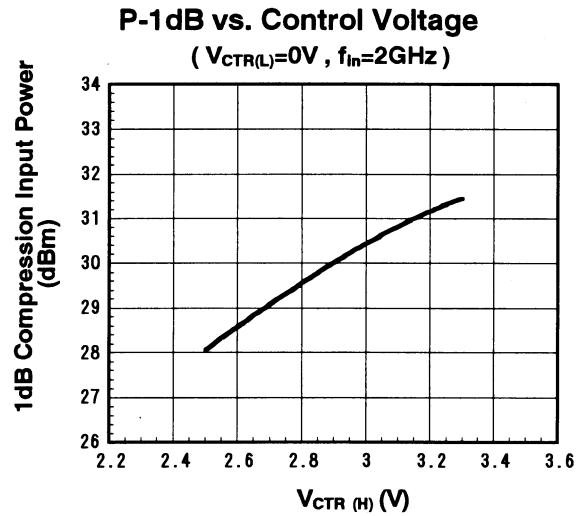
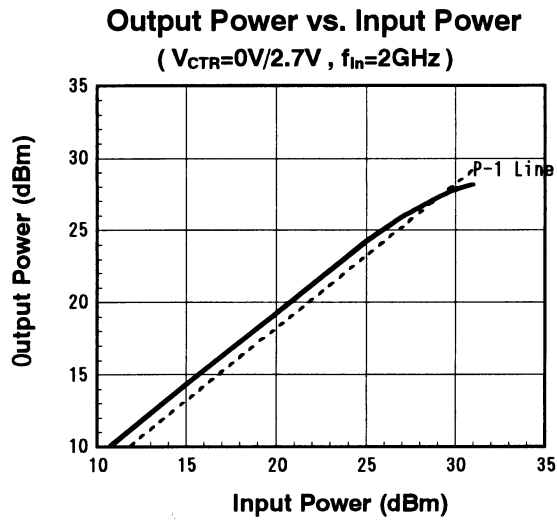

■ TYPICAL CHARACTERISTICS

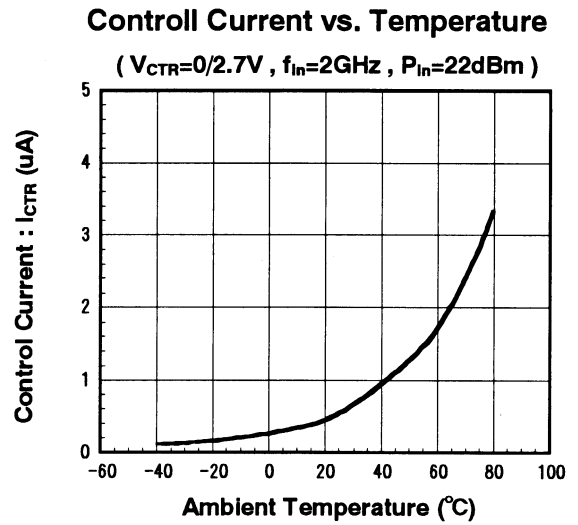
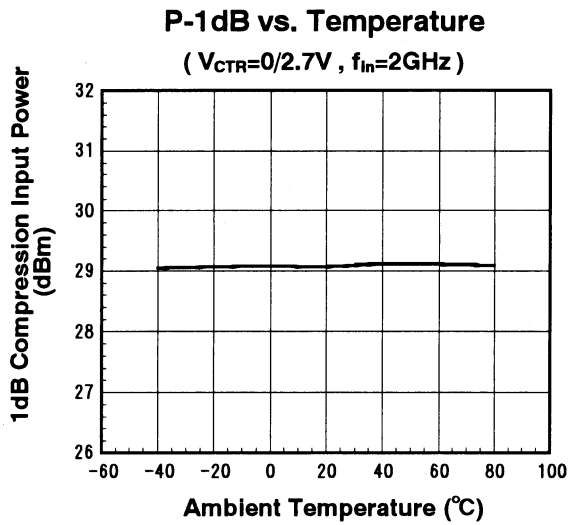
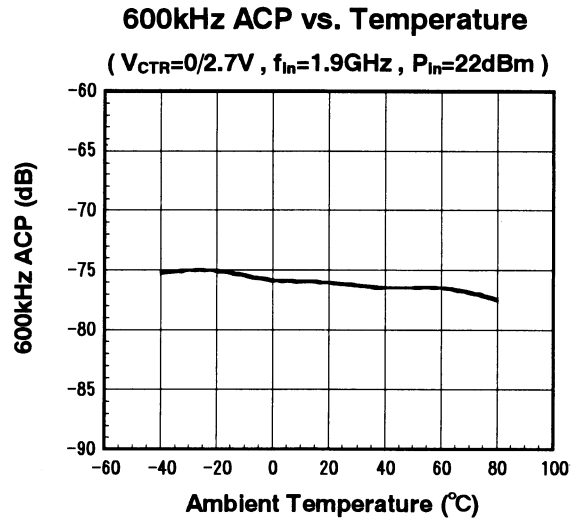
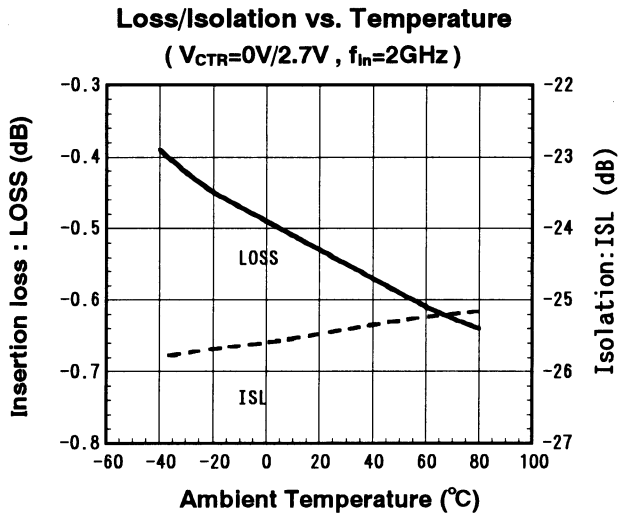

■ TYPICAL CHARACTERISTICS

600kHz ACP 特性 (Ta=25°C)

DQPSK Modulation Signal (without D.U.T)

$f_{in}=1.9\text{GHz}$ $P_{in}=22\text{dBm}$

MODULATION : 384Kbps RNYQ $\alpha=0.5$ $1/4 \pi$ DQPSK

-ATTEN 20dB

RL 10.0dBm 10dB/

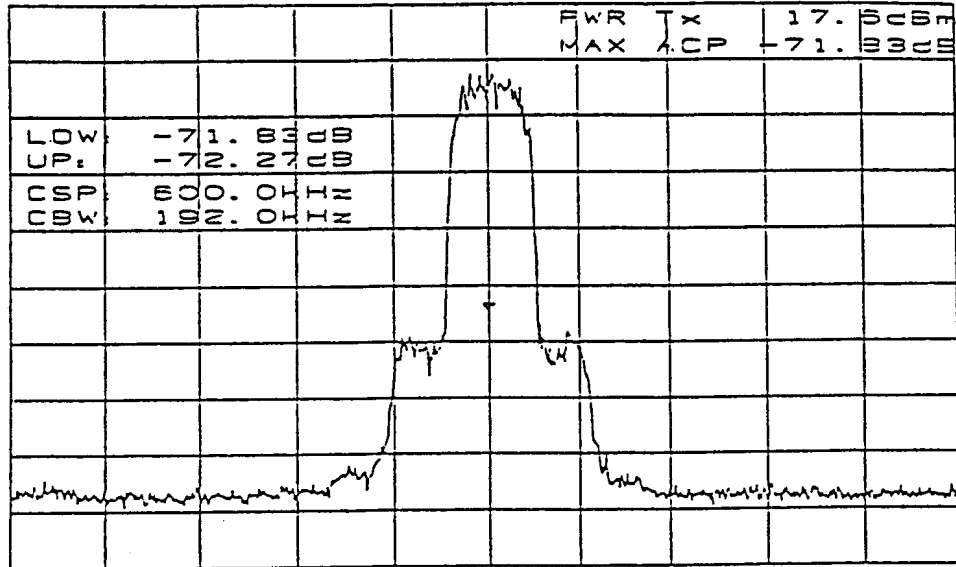

CENTER 1.900000GHz

SPAN 3.000MHz

-RBW 1.0kHz -VBW 10kHz

-SWP 10.2sec

Insertion PORT : PC → P1

$f_{in}=1.9\text{GHz}$ $P_{in}=22\text{dBm}$ $V_{CTR}=0/2.7\text{V}$

MODULATION : 384Kbps RNYQ $\alpha=0.5$ $1/4 \pi$ DQPSK

-ATTEN 20dB

RL 10.0dBm 10dB/

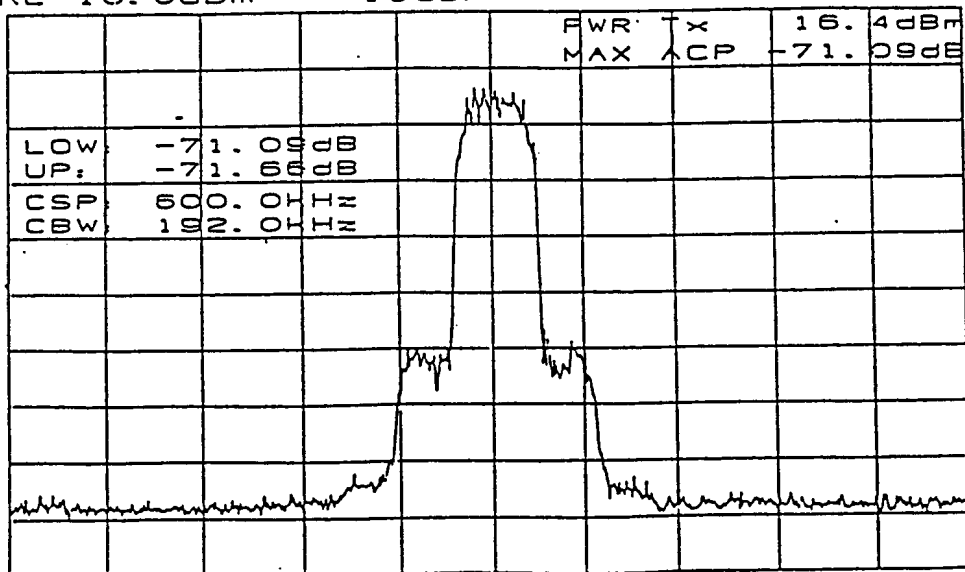

CENTER 1.900000GHz

SPAN 3.000MHz

-RBW 1.0kHz -VBW 10kHz

SWP 7.50sec

NJG1509F

■TYPICAL CHARACTERISTICS

900kHz ACP (Ta=25°C)

Insertion PORT: PC → P1

f_{in}=1.9GHz P_{in}=22dBm V_{CTR}=0/2.7V

MODULATION: 384Kbps RNYQ α=0.5 1/4 π DQPSK

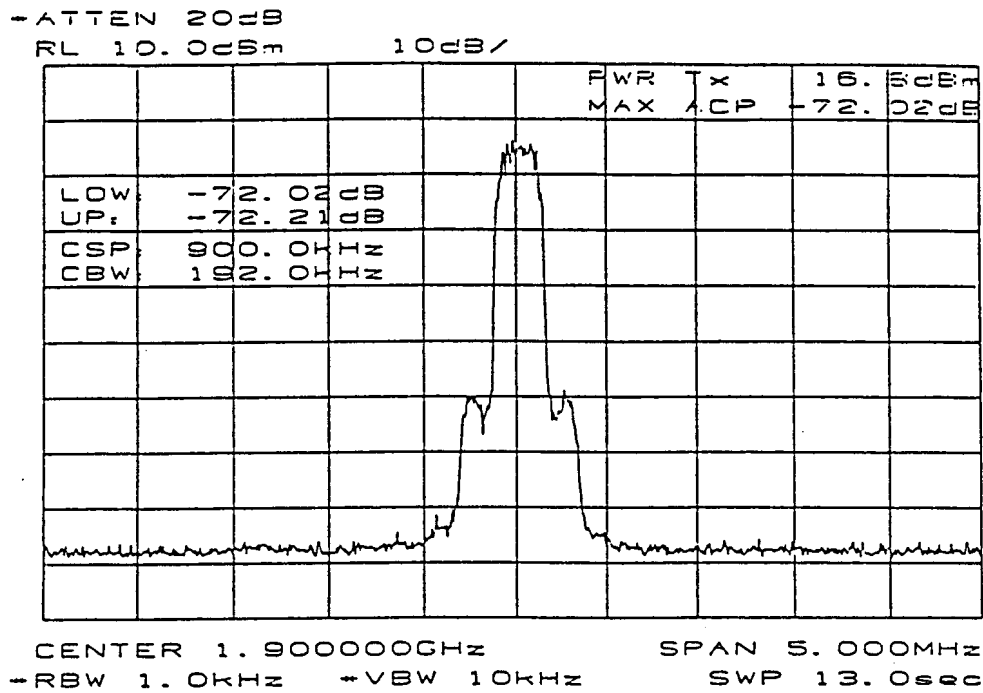

Harmonics (Ta=25°C)

f_{in}=1.9GHz P_{in}=22dBm V_{CTR(H)}=2.7V

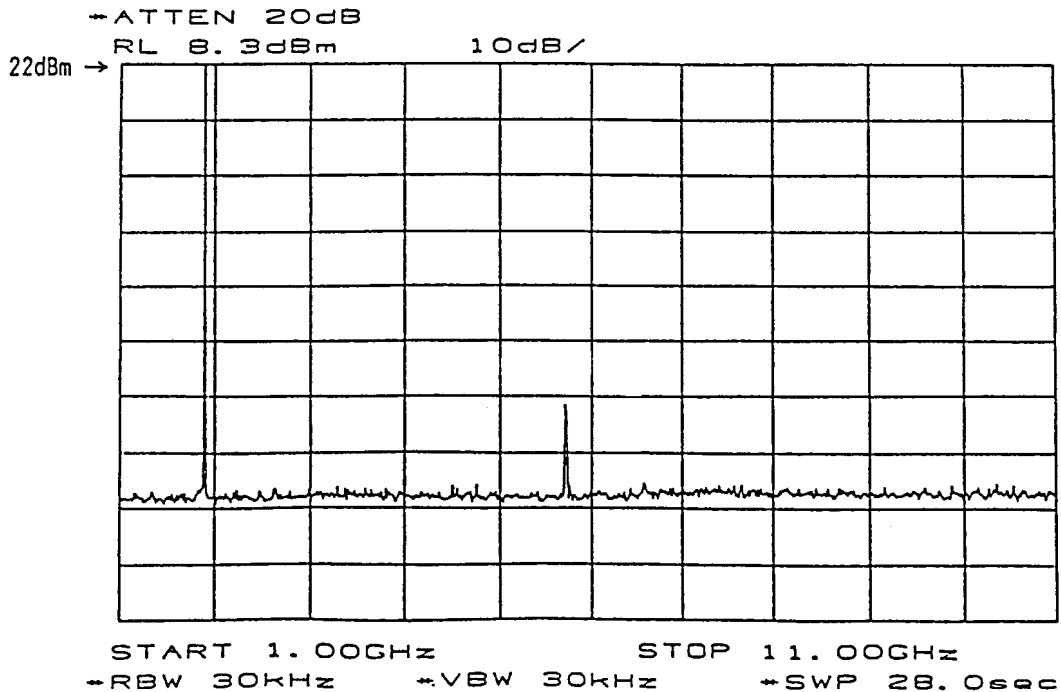

TYPICAL CHARACTERISTICS

P1 PORT IMPEDANCE (OFF STATE)

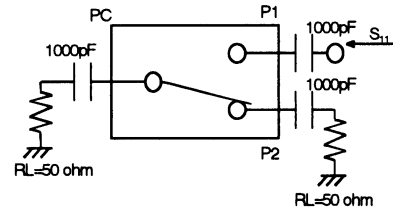
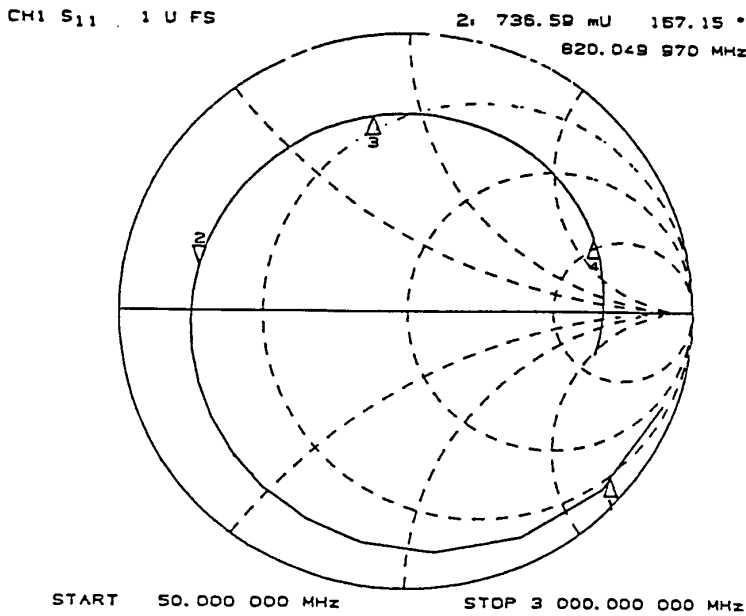

MARKER	f (MHz)	Mag.	Ang. (∠°)
1	50	0.954	-15.4
2	800	0.755	-172.5
3	1500	0.716	113.6
4	2000	0.710	72.3
5	3000	0.693	1.4

P2 PORT IMPEDANCE (OFF STATE)

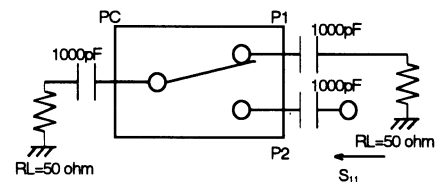
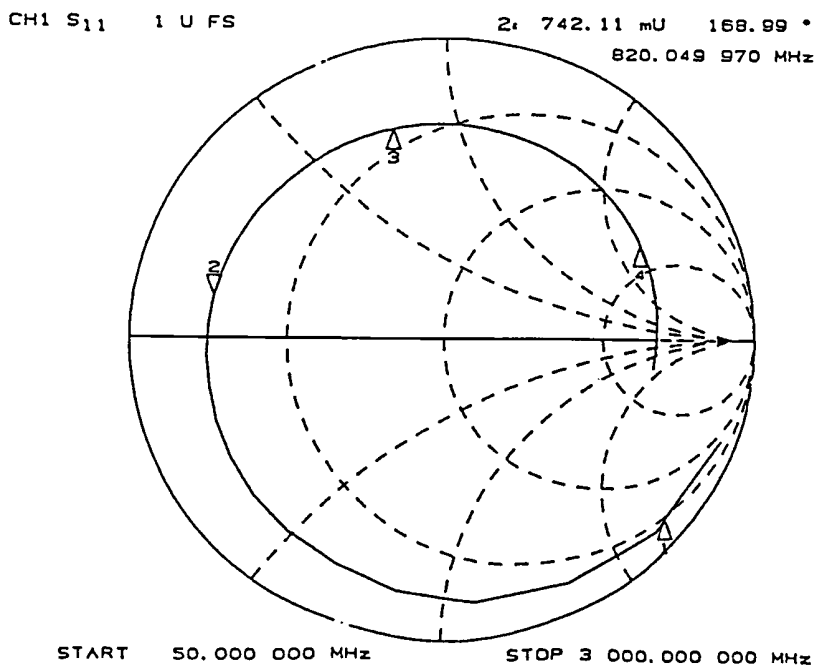

MARKER	f (MHz)	Mag.	Ang. (∠°)
1	50	0.952	-15.5
2	800	0.767	-173.6
3	1500	0.731	111.1
4	2000	0.723	68.7

■ TYPICAL CHARACTERISTICS

Scattering Parameters: S11 (OFF STATE)

($V_{CTR}=0/2.7V$, 50Ω System)

f(MHz)	P1 PORT		P2 PORT	
	Mag.	Ang.(\angle°)	Mag.	Ang.(\angle°)
50	0.954	-15.4	0.952	-15.5
100	0.945	-30.9	0.945	-31.0
200	0.909	-59.0	0.910	-59.2
300	0.872	-84.5	0.879	-84.9
400	0.837	-106.8	0.844	-107.2
500	0.809	-126.3	0.817	-127.1
600	0.783	-143.4	0.793	-144.3
700	0.766	-158.8	0.778	-159.8
800	0.755	-172.5	0.767	-173.6
900	0.743	174.9	0.758	173.4
1000	0.734	163.1	0.749	161.7
1100	0.722	151.5	0.736	150.0
1200	0.724	141.8	0.737	139.8
1300	0.722	132.0	0.733	129.9
1400	0.719	122.6	0.734	120.4
1500	0.716	113.6	0.731	111.1
1600	0.716	104.9	0.730	102.2
1700	0.714	96.7	0.726	93.7
1800	0.713	88.2	0.725	85.2
1900	0.712	80.2	0.723	76.9
2000	0.710	72.3	0.723	68.7
2100	0.710	65.0	0.723	61.2
2200	0.710	57.4	0.721	53.2
2300	0.708	49.9	0.716	45.5
2400	0.707	42.6	0.717	38.2
2500	0.705	35.4	0.714	30.7
2600	0.703	28.6	0.712	23.6
2700	0.703	21.9	0.711	16.7
2800	0.700	14.8	0.709	9.3
2900	0.696	8.0	0.707	2.3
3000	0.693	1.4	0.701	-4.8

APPLICATION CIRCUIT 1: Single control signal operation by using C-MOS inverter.

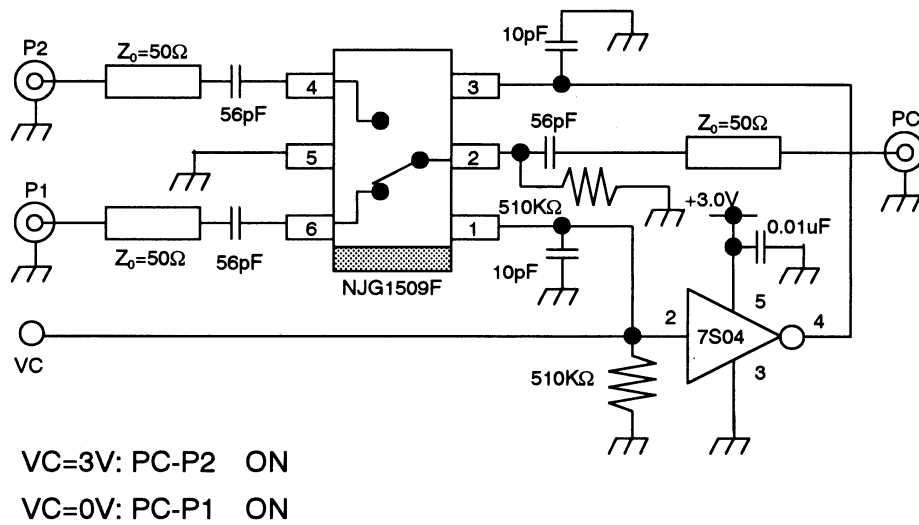

- [1]Please connect bypass capacitors to the supply terminal of the C-MOS inverter.
- [2]In order to stabilize input impedance of inverter, please pull down using 510KΩ resistor from the input terminal of the C-MOS inverter to the ground plane.

APPLICATION CIRCUIT 2: Single control signal operation by using a transistor.

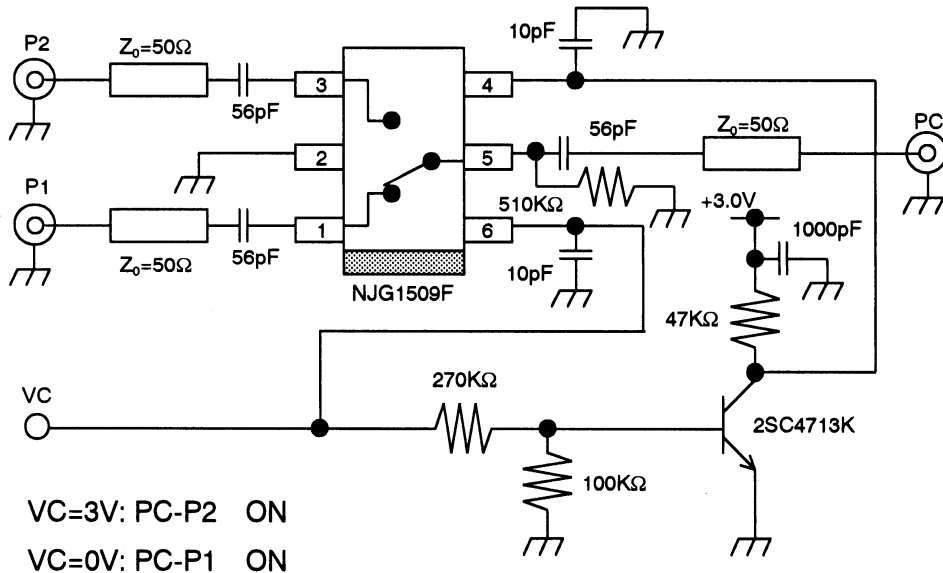

NJG1509F

TEST CIRCUIT

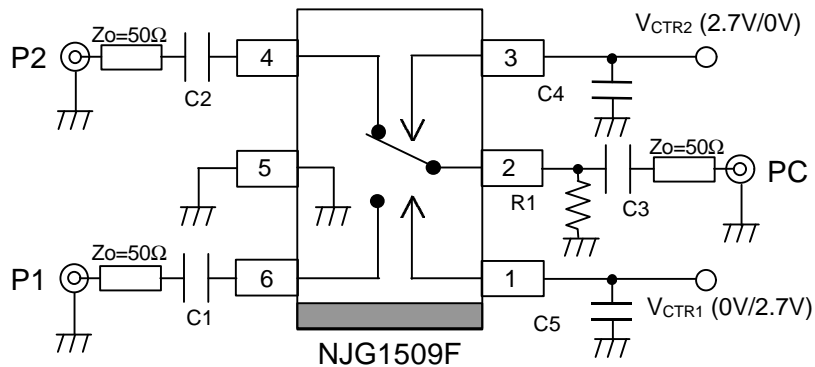

RECOMMENDED PCB DESIGN

(TOP VIEW)

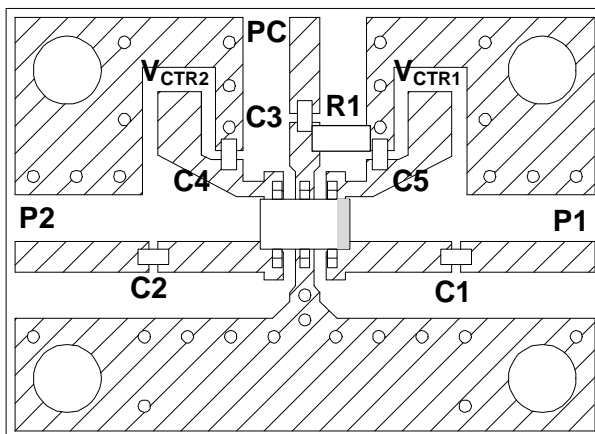

PCB SIZE=19.4x14.0mm
 PCB: FR-4, t=0.5mm
 CAPACITOR: size 1005
 STRIP LINE WIDTH=1mm
 C1~C3: 56pF
 C4, C5: 10pF
 R1: 510KΩ

Precaution

- [1] External capacitors should be connected to the input and output RF terminals (P1, P2, PC) to block the DC current. The above example is a circuit at 900MHz. Please select the capacitors value suitable for actual frequency from 10pF to 1000pF.
- [2] Decoupling capacitors should be connected to the control terminals (V_{CTR1} , V_{CTR2}) as close as possible. The values of these capacitors should be selected from 5pF to 100pF range. Please consider that these values are very effective to switching time (Larger capacitor gives longer switching time).
- [3] In order to keep good isolation characteristics, the ground terminal (5pin) should be connected to the ground pattern with wide width as close as possible, and though-hole in the ground plane should also be placed as close as possible.

■PACKAGE OUTLINE (MTP6)

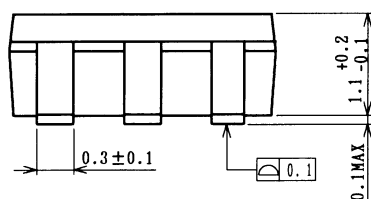
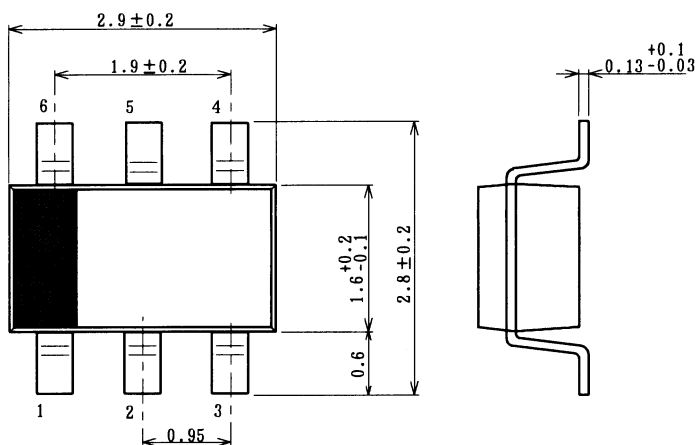

Lead material	: Copper
Lead surface finish	: Solder plating
Molding material	: Epoxy resin
UNIT	: mm
Weight	: 14mg

Cautions on using this product

- This product contains Gallium-Arsenide (GaAs) which is a harmful material.
- Do NOT eat or put into mouth.
 - Do NOT dispose in fire or break up this product.
 - Do NOT chemically make gas or powder with this product.
 - To waste this product, please obey the relating law of your country.

[CAUTION]

The specifications on this databook are only given for information, without any guarantee as regards either mistakes or omissions. The application circuits in this databook are described only to show representative usages of the product and not intended for the guarantee or permission of any right including the industrial rights.

This product may be damaged with electric static discharge (ESD) or spike voltage. Please handle with care to avoid these damages.