

PHOTO REFLECTOR

■ GENERAL DESCRIPTION

The NJL5365K is super miniature and super thin type photo reflector, which consist of green emitting diode and high sensitive Si photo transistor.

■ FEATURES

- Super miniature, sealed package.
- Peak emitting wave length 570nm: It is possible to detect even red ink which is difficult to detect by infrared or red light.

■ ABSOLUTE MAXIMUM RATINGS (Ta=25°C)

PARAMETER	SYMBOL	RATINGS	UNIT
Emitter			
Forward Current (Continuous)	I _F	20	mA
Reverse Voltage (Continuous)	V _R	4	V
Power Dissipation	P _D	50	mW
Detector			
Collector-Emitter Voltage	V _{CEO}	10	V
Emitter-Collector Voltage	V _{ECO}	6	V
Collector Current	I _C	20	mA
Collector Dissipation	P _C	75	mW
Coupler			
Total Power Dissipation	P _{tot}	100	mW
Operating Temperature	T _{opr}	-20~+80	°C
Storage Temperature	T _{stg}	-30~+100	°C
Soldering Temperature	T _{sol}	260	°C
		(10sec. 1.5mm from body)	

■ OUTLINE (typ.) Unit: mm

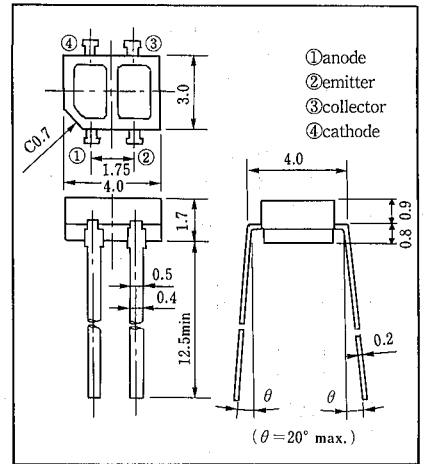

■ ELECTRO-OPTICAL CHARACTERISTICS (Ta=25°C)

PARAMETER	SYMBOL	TEST CONDITION	MIN.	TYP.	MAX.	UNIT
Emitter						
Forward Voltage	V _F	I _F = 4mA	—	1.9	2.3	V
Reverse Current	I _R	V _R = 4V	—	—	100	μA
Peak Wavelength	λ _P	I _F = 10mA	—	570	—	nm
Detector						
Dark Current	I _{CEO}	V _{CE} = 10V	—	—	100	nA
Collector-Emitter Voltage	V _{CEO}	I _C = 100μA	10	—	—	V
Emitter-Collector Current	I _{ECO}	V _{ECO} = 6V	—	—	100	μA
Coupled						
Output Current	I _O	I _F = 4mA, V _{CE} = 2V, d = 0.7mm	0.8	—	5.0	μA
Operating Dark Current	I _{CEOD}	I _F = 4mA, V _{CE} = 2V	—	—	100	nA

(note) : For quality improvement, this product is made on special specification. Please make an inquiry in advance in regard to desired long life in application, as there might be cases of restrictions for applying condition.

MEASURING SPECIFICATION FOR OUTPUT CURRENT

The Output Current can be measured when reflected at the aluminum evaporation mirror.

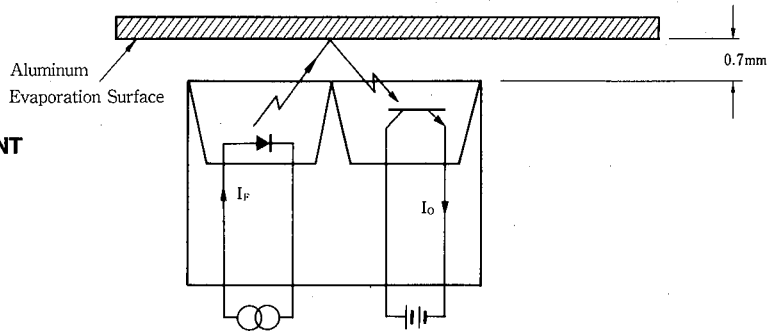

MEASURING CIRCUIT FOR OPERATING DARK CURRENT

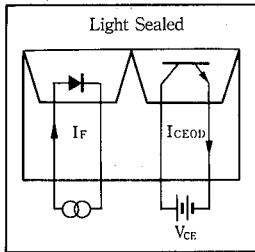

MEASURING CIRCUIT FOR RESPONSE TIME

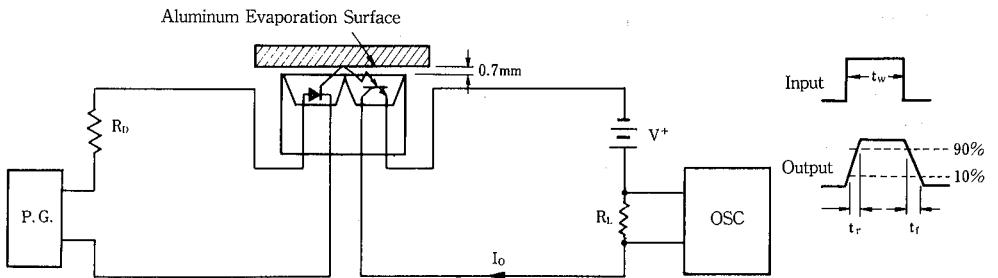

MAXIMUM RATING CURVES

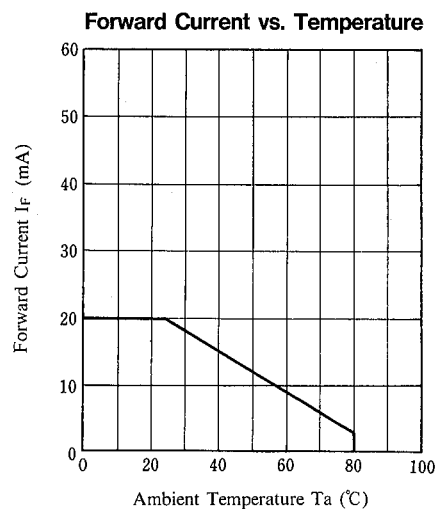
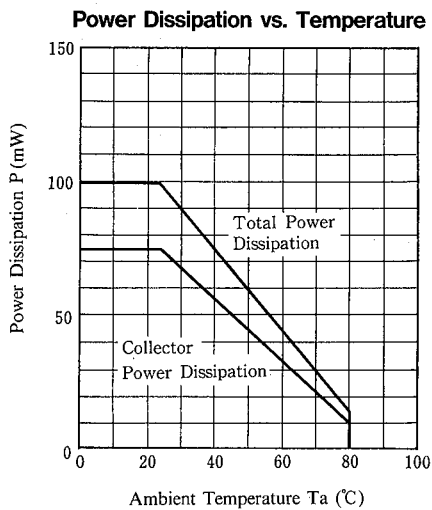

■ TYPICAL CHARACTERISTICS

Forward Current vs. Forward Voltage

($T_a = 75^\circ\text{C}, 50^\circ\text{C}, 25^\circ\text{C}, 0^\circ\text{C}, -20^\circ\text{C}$)

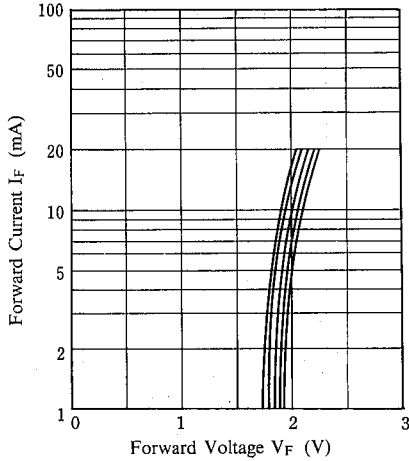

Dark Current vs. Temperature

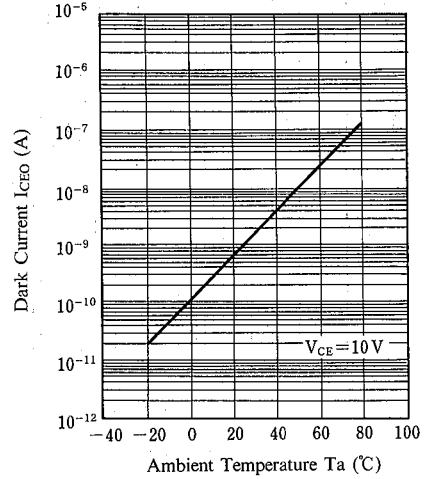

Output Current vs. Forward Current ($T_a = 25^\circ\text{C}$)

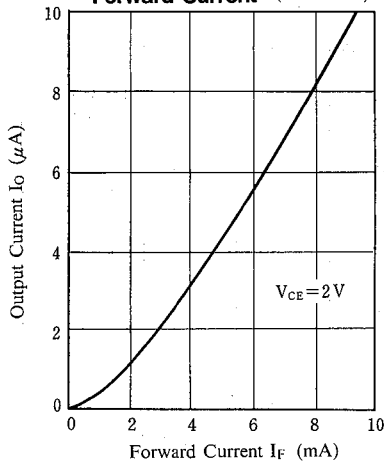

Output Current vs. Temperature

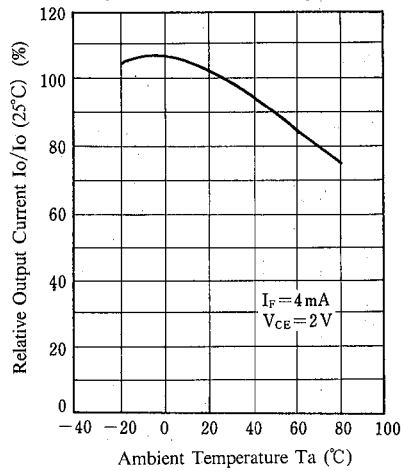

Operating Dark Current vs. Temperature

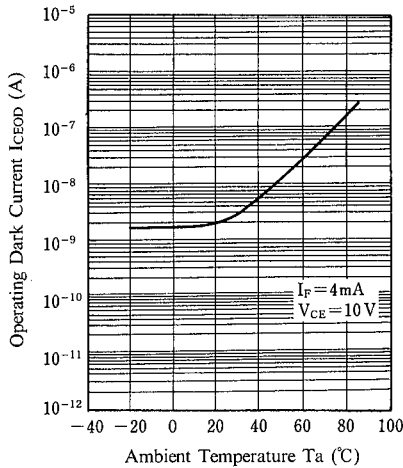

Output Characteristics ($T_a = 25^\circ\text{C}$)

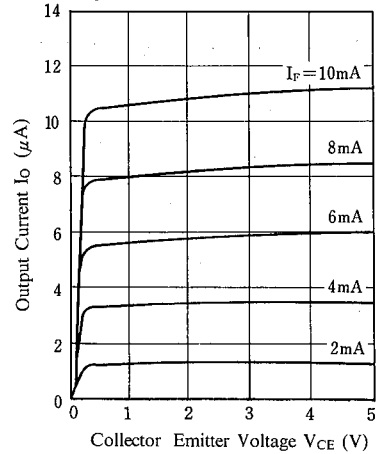

2

2

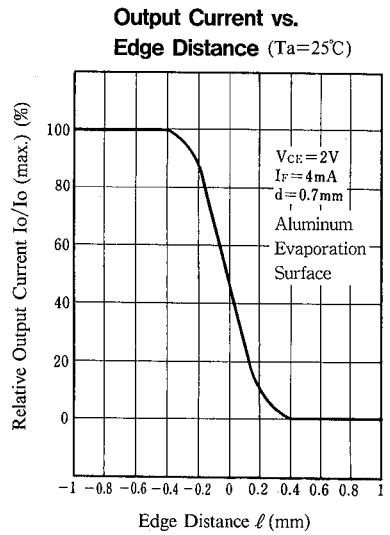
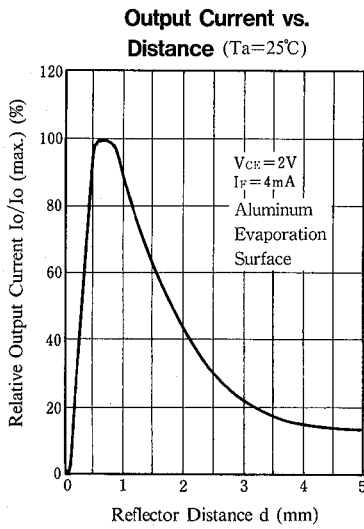
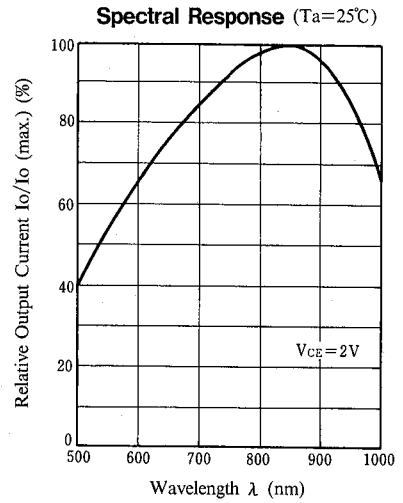
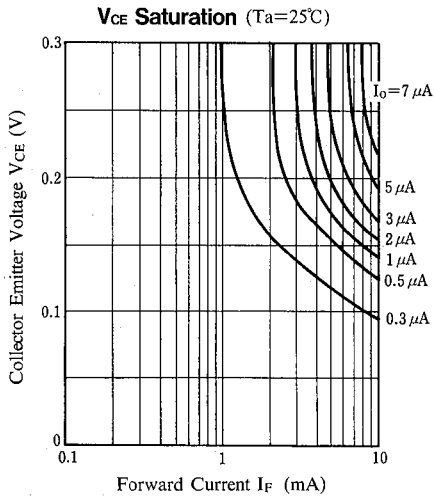

■ MEASURING SPECIFICATION FOR EDGE RESPONSE

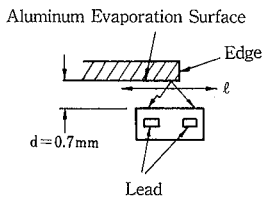

PRECAUTION FOR HANDLING

1. Soldering

- 1) Avoid the reflow method and the solder to touch the body of the device during wave soldering. This is to prevent changes in optical characteristics of the device.
- 2) Recommended in Soldering

Temperature	Time Lead	Soldering Position
260°C maximum	less than 10 seconds	At least 1.5mm from body
- 3) Soldering is recommended to be done in as short period of the time as possible by controlling the temperature of the soldering iron or by the iron of less than 15 watts.
- 4) The resin gets softened right after soldered, so, the following care has to be taken.
 - Not to contact the lens surface to anything
 - Not to dip the device into water or any solvents
- 5) It is recommended not to solder when the leads or between the lead get pulled, depressed or twisted.
- 6) In the case of using rosin flux, be careful to avoid contact with the lens surface. If the lens is covered with the flux, the specified characteristics cannot be achieved.

2. Post Solder Cleaning

- 1) Organic solvents for flux removal like trichloroethylene, acetone, thinner etc, might attack the lens surface. It is preferable to use less reactive solvents, Methyl Alcohol, Isopropyle Alcohol.
- 2) Cleaning Operation

Cleaning Solvent Temperature	: 35°C maximum
Dipping Time	: 3 minute maximum

3. Attention in handling

- 1) Treat not to touch the lens surface.
- 2) Avoid dust and any other foreign materials(flux, paint, bonding material, etc)on the lens surface.
- 3) Never to apply reverse voltage(V_{EC}) of more than 6V on the photo transistor when measuring the characteristics or adjusting the system. If applied, it causes to lower the sensitivity.
- 4) When mounting, special care has to be taken on the mounting position and tilting of the device because it is very important to place the device to the optimum position to the object.

4. Storage

The leads are silver plated and they are discolored if the device is left open to the air for long after taken out of the envelope. It causes deterioration of soldering characteristics. Mount the device as short as possible after opening the envelope.

2

MEMO

[CAUTION]

The specifications on this databook are only given for information, without any guarantee as regards either mistakes or omissions. The application circuits in this databook are described only to show representative usages of the product and not intended for the guarantee or permission of any right including the industrial rights.