

RF AMPLIFIER FOR CD PLAYER

■ GENERAL DESCRIPTION

NJM2117 is designed for CD player, which contains RF amplifier for 3 spot system optical PICK-UP output, FOCUS error amplifier and APC circuit.

■ PACKAGE OUTLINE

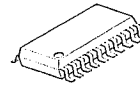

NJM2117V

■ FEATURES

- Dual Supply $\pm 5V$ Operation
- Single Supply +5V Operation Available
- Package Outline SSOP20
- Bipolar Technology

■ PIN FUNCTION

- | | |
|-------------------|--------------------|
| 1. LD | 20. V ⁺ |
| 2. PD | 19. LD ON |
| 3. PD1 | 18. RFI |
| 4. PD2 | 17. RFO |
| 5. V ⁻ | 16. FE |
| 6. F | 15. FE BIAS |
| 7. E | 14. TE |
| 8. VR | 13. EI |
| 9. VC | 12. EO |
| 10. NC | 11. NC |

■ BLOCK DIAGRAM

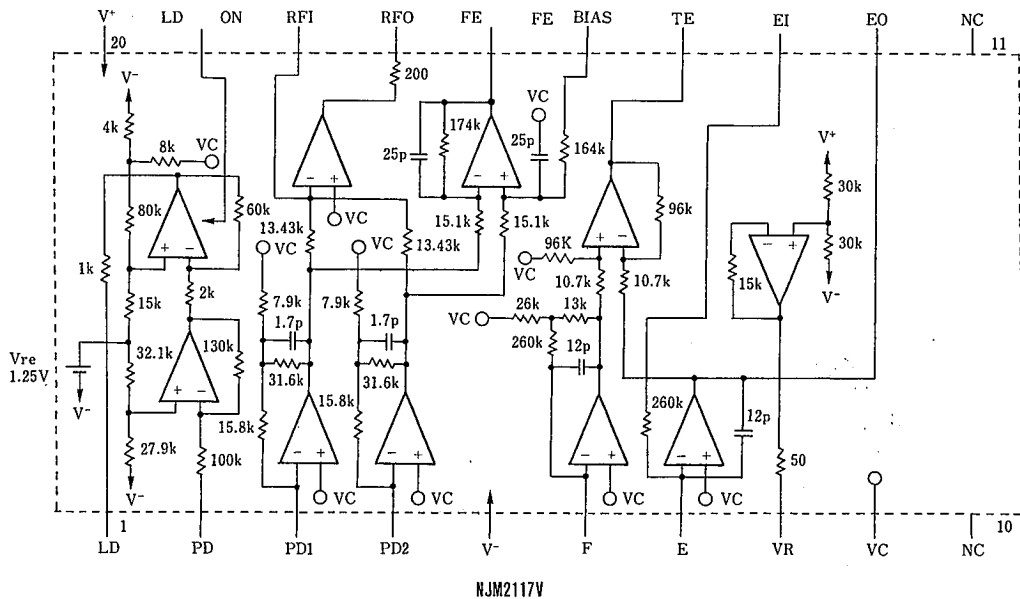

5

■ ABSOLUTE MAXIMUM RATINGS

(Ta=25°C)

PARAMETER	SYMBOL	RATINGS	UNIT
Supply Voltage	V ⁺ /V	±6	V
Power Dissipation	P _D	(SSOP8) 300	mW
Operating Temperature Range	T _{opr}	-20~+75	°C
Storage Temperature Range	T _{stg}	-40~+125	°C

■ ELECTRICAL CHARACTERISTICS

(V⁺/V=±5.0V, Ta=25°C)

PARAMETER	SYMBOL	TEST CONDITION	MIN.	TYP.	MAX.	UNIT
Operating Current	I _{CC}	20pin	—	8.0	12.0	mA
Operating Current	I _{EE}	5pin	-12.0	-8.0	—	mA
<RF Amplifier>						
Output Offset Voltage	V _{OO1}	TP17 Voltage	-50	—	50	mV
Voltage Gain	G _{V 1}	TP3/4=2KHz, 30mV _{rms} INPUT	28.2	31.2	34.2	dB
Frequency Characteristic	FG _{V 1}	Frequency at G _{V 1} =-3dB	1.50	3.75	—	MHZ
Maximum Output Voltage H	+V _{OM1}	TP3=0.6V	3.5	—	—	V
Maximum Output Voltage L	-V _{OM1}	TP3=-0.6V	—	—	-0.3	V
<FE Amplifier>						
Output Offset Voltage	V _{OO2}	TP16 Voltage	-120	0	120	mV
Output Noise	V _{NOISE}	S3=ON: TP16Noise (100KHZ LPF)	—	15	30	mV _{rms}
Voltage Gain 1	G _{V 2-1}	TP3=1KHz, 10mV _{rms} Input	39.1	42.1	45.1	dB
Voltage Gain 2	G _{V 2-2}	TP4=1KHz, 10mV _{rms} Input	39.1	42.1	45.1	dB
Frequency Characteristic 1	FG _{V 2-1}	Frequency at G _{V 2-1} =-3dB	—	27	—	KHZ
Frequency Characteristic 2	FG _{V 2-2}	Frequency at G _{V 2-2} =-3dB	—	27	—	KHZ
Difference Voltage Gain	G _{VD2}	G _{VD2} =(G _{V 2-1})-(G _{V 2-2})	-3.0	0	3.0	dB
Maximum Output Voltage H	+V _{OM2}	TP3=0.3V	4.2	—	—	V
Maximum Output Voltage L	-V _{OM2}	TP4=0.3V	—	—	-2.2	V
<TE Amplifier>						
Output Offset Voltage	V _{OO3}	TP14 Voltage	-50	0	50	mV
Voltage Gain 1	G _{V 3-1}	TP6=1KHz, 100mV _{rms} Input	16.4	19.4	22.4	dB
Voltage Gain 2	G _{V 3-2}	TP7=1KHz, 100mV _{rms} Input	16.4	19.4	22.4	dB
Frequency Characteristic 1	FG _{V 3-1}	Frequency at G _{V 3-1} =-3dB	—	34	—	KHZ
Frequency Characteristic 2	FG _{V 3-2}	Frequency at G _{V 3-2} =-3dB	—	34	—	KHZ
Difference Voltage Gain	G _{VD3}	G _{VD3} =(G _{V 3-1})-(G _{V 3-2})	-3.0	0	3.0	dB
Maximum Output Voltage H	+V _{OM3}	TP7=1.5V	4.2	—	—	V
Maximum Output Voltage L	-V _{OM3}	TP6=1.5V	—	—	-2.2	V
<APC>						
Output Voltage 1	V _{O 1}	S ₂ = 2 V ₁ =69mV V ₂ =0.5V	—	-1.7	-0.4	V
Output Voltage 2	V _{O 2}	S ₂ = 2 V ₁ =123mV V ₂ =0.5V	-1.0	0.3	1.6	V
Output Voltage 3	V _{O 3}	S ₂ = 2 V ₁ =177mV V ₂ =0.5V	1.0	2.3	—	V
Output Voltage 4	V _{O 4}	S ₂ = 2 V ₁ =0V V ₂ =4.5V	4.6	4.8	—	V
Output Voltage 5	V _{O 5}	S ₁ =ON S ₂ = 2 V ₁ =0V V ₂ =0.5V	—	—	2.0	V
<Center Voltage Amp.>						
Output Voltage 6	V _{O 6}	TP8 Voltage	-100	0	100	mV

5

■ TERMINAL EXPLANATION

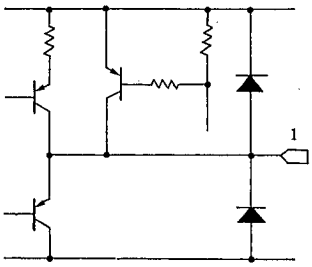
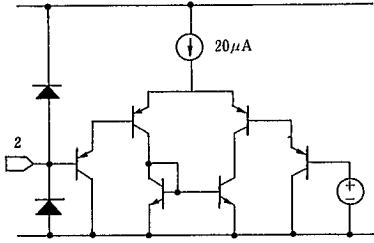
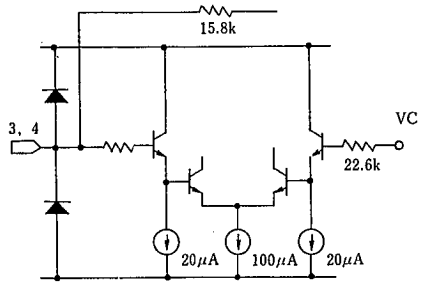
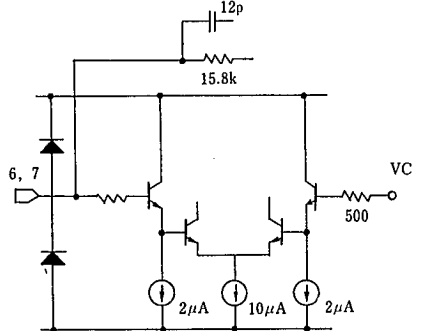
PIN NO.	SYMBOL	EQUIVALENT CIRCUIT*	TERMINAL EXPLANATION
1	LD		Output pin of APC AMP.
2	PD		Input pin of APC AMP.
3 4	PD1 PD2		Input pin of RF I-V AMP. Connect A+C pin, B+D pin of each photo-diode and current input.
5	V _{EE}		Connect minus supply. ...(Two supply) Connect GND. ...(Single supply)
6 7	F E		Input pin of TE I-V AMP. Connect E pin, F pin of each photo-diode and current input.

5

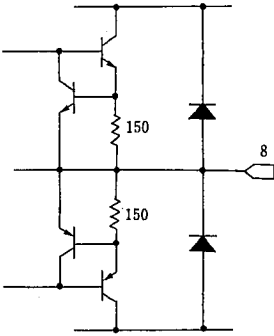
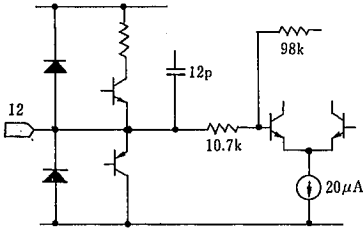
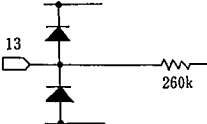
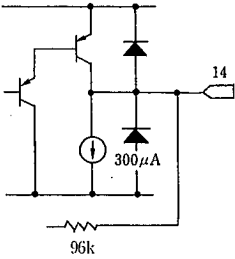
PIN NO.	SYMBOL	EQUIVALENT CIRCUIT	TERMINAL EXPLANATION
8	VR		Output pin of direct current $(V_{CC} + V_{EE})/2$.
9	VC		Input pin of internal center point voltage. Connect GND.....($\pm 5V$) Connect VR pin.(Single supply)
12	EO		Output pin for monitor of I-V AMP E.
13	EI		Gain adjustment pin of I-V AMP E.
14	TE		Output pin of TRACKING ERROR AMP. Output of E-F signal.

5

PIN NO.	SYMBOL	EQUIVALENT CIRCUIT	TERMINAL EXPLANATION
15	FE-BIAS		Bias adjustment pin of FOCUS ERROR AMP. (Non-inverting side)
16	FE		Output pin FOCUS ERROR AMP.
17	RFO		Output pin RF AMP.
18	RFI		Input pin of RF AMP. (Inverting side) Establish Gain of RF AMP by resistor between RFI pin and RFO pin.
19	LD ON		Change-over pin(on/off) of APC AMP. ON...GND/OFF...Vcc
20	Vcc		Connect plus supply.(Two supply) Connect Vcc.(Single supply)

5

RF AMP

RFO-OUTPUT

$$V_{RFO} = (iPD1 + iPD2)(A) \times 111(k\Omega) \times \frac{22(k\Omega)}{13.43(k\Omega)}$$

$$= 181.8(k\Omega) \times (iPD1 + iPD2)(A)$$

Establish Gain of RF AMP by resistor (22kΩ) between RFI pin and RFO pin.

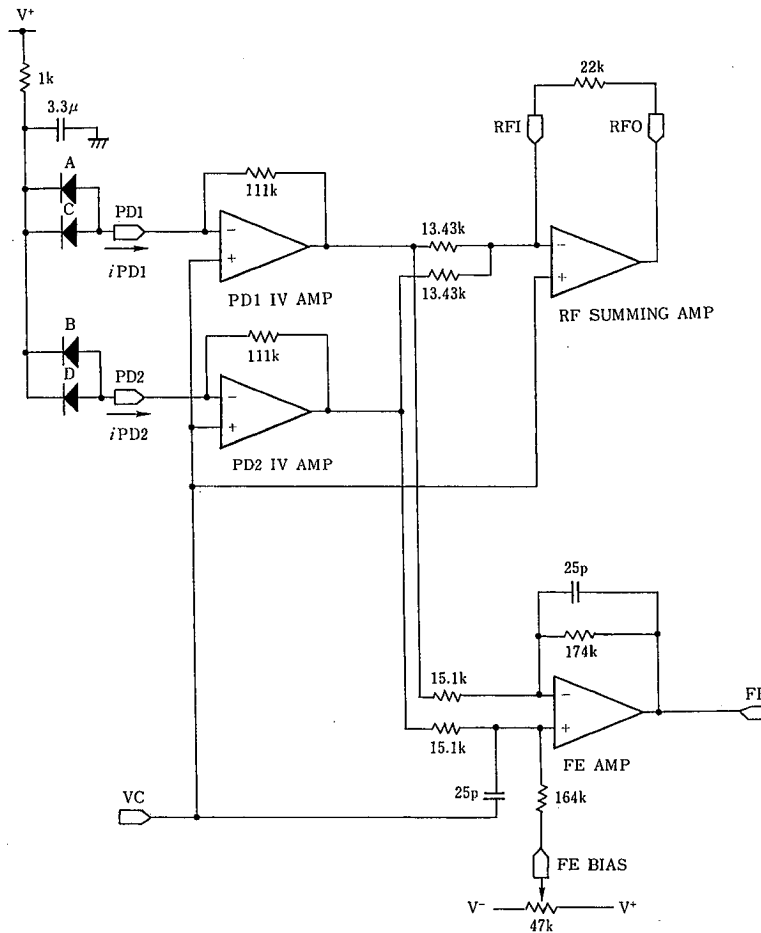

5

FE AMP

FE OUTPUT

$$V_{FE} = (i_{PD1} - i_{PD2})(A) \times 111(k\Omega) \times \frac{174(k\Omega)}{15.1(k\Omega)}$$

$$= 1279(k\Omega) \times (i_{PD1} - i_{PD2})(A)$$

It is possible to control FE Output Offset by variable resistor with FE BIAS pin.

TE AMP

TE OUTPUT

$$V_{TE} = (i_E - i_F)(A) \times 403(k\Omega) \times \frac{96(k\Omega)}{10.7(k\Omega)}$$

$$= 3616(k\Omega) \times (i_E - i_F)(A)$$

It is possible to trim I-V Gain by resistor with ED pin.

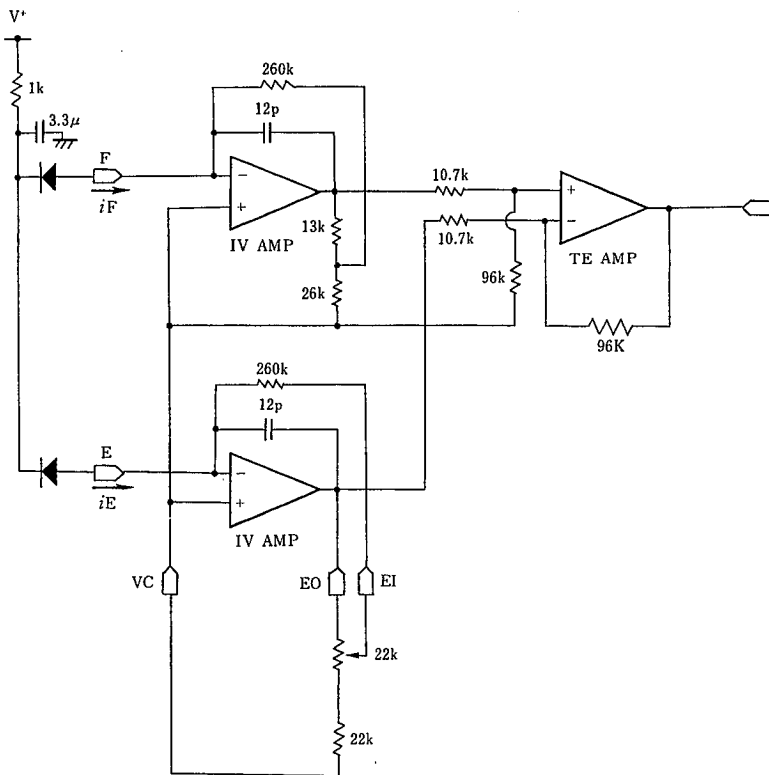

NJM2117

CENTER VOLTAGE GENERATION CIRCUIT

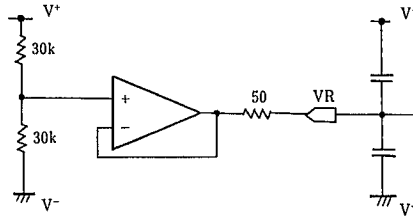

APC CIRCUIT

LD ON pin: connect to GND...APC (Auto Power Control) ON
connect to V+...APC (" ") OFF

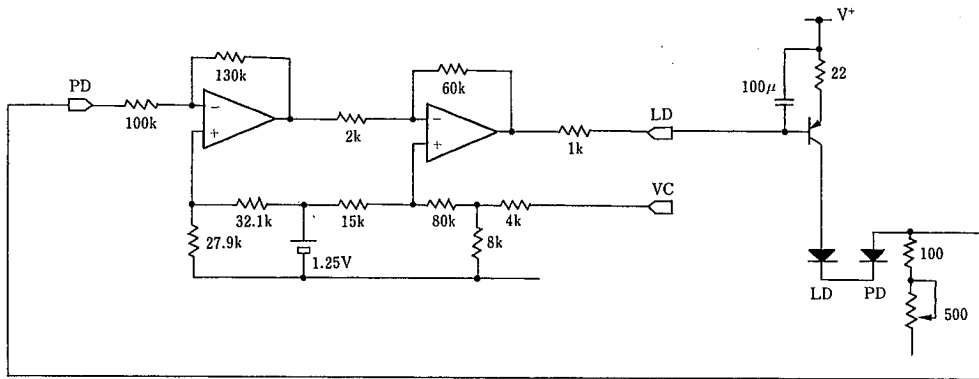

5

■ TYPICAL APPLICATION

1) $\pm 5V$ (TWO SUPPLY VOLTAGE)

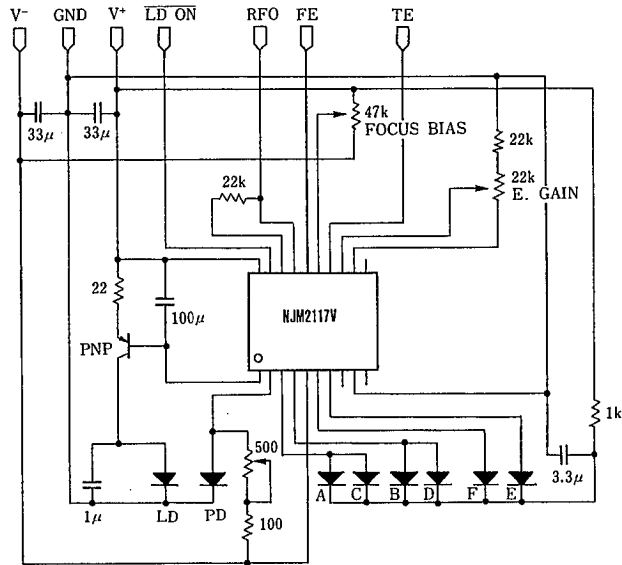

2) $+5V$ (SINGLE SUPPLY VOLTAGE)

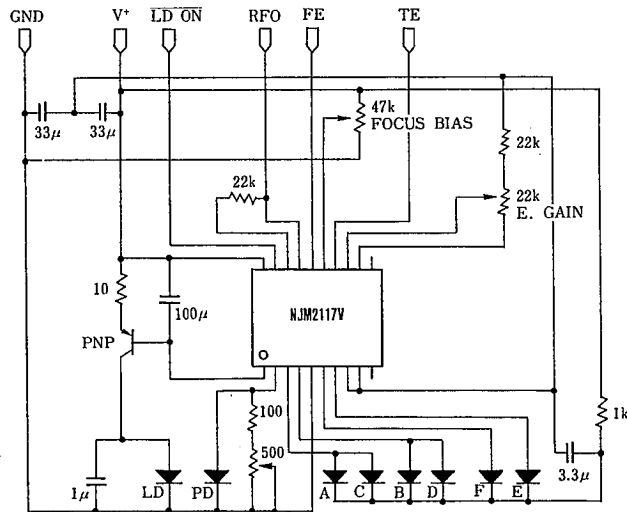

5

■ TYPICAL CHARACTERISTICS

Operating Current (I_{CC}) vs. Temperature

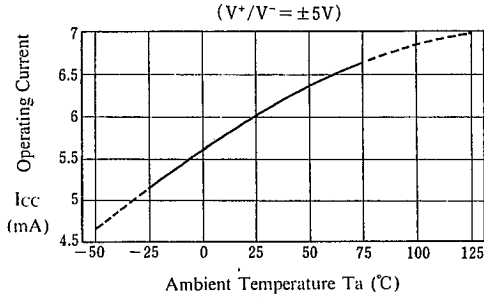

Operating Current (I_{EE}) vs. Temperature

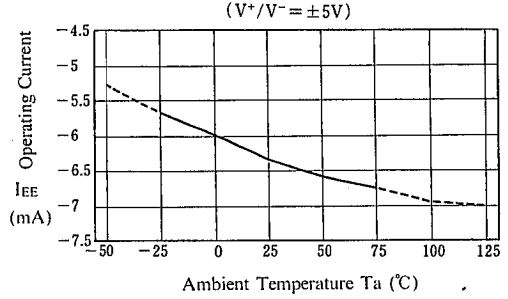

RF Output Offset Voltage vs. Temperature

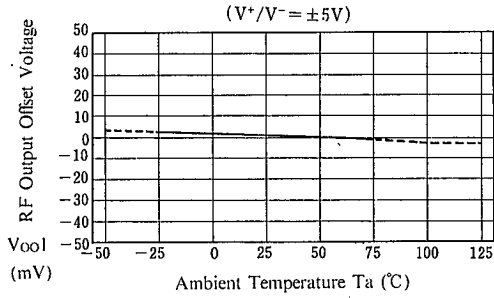

FE Output Offset Voltage vs. Temperature

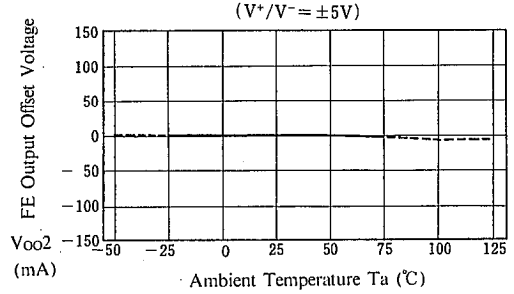

TE Output Offset Voltage vs. Temperature

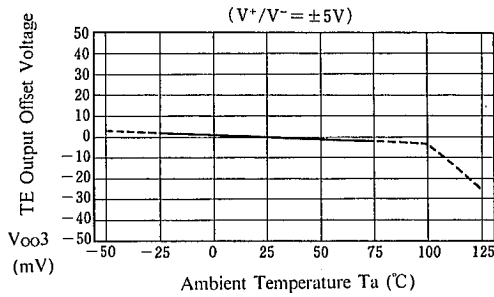

Center Voltage vs. Temperature

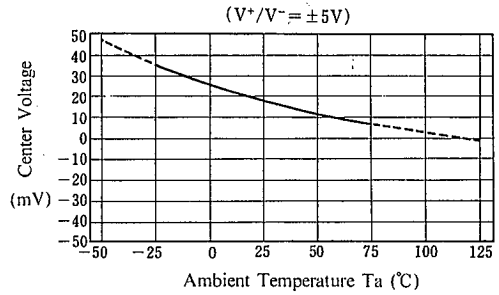

■ TYPICAL CHARACTERISTICS

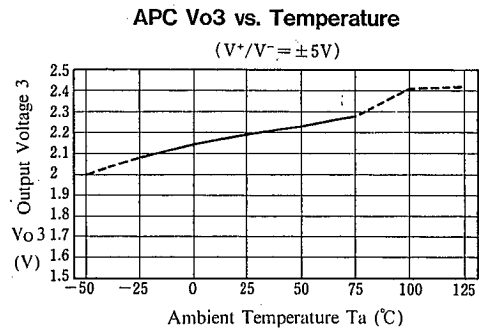
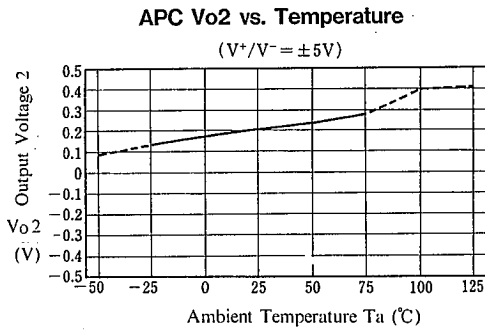
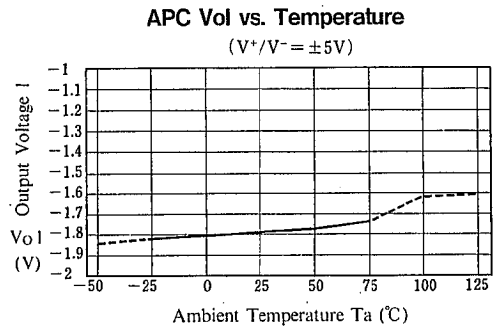
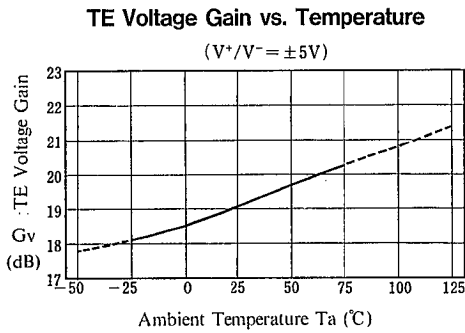
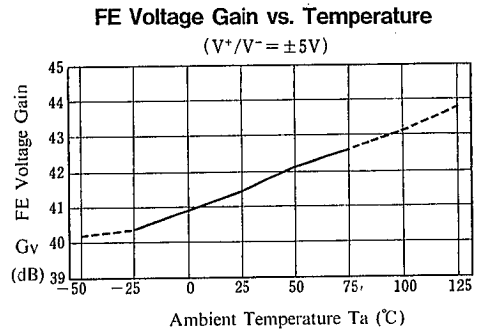
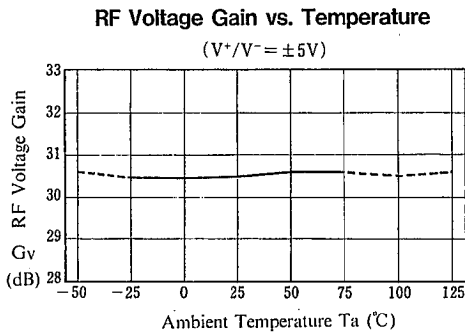

5

■ TYPICAL CHARACTERISTICS

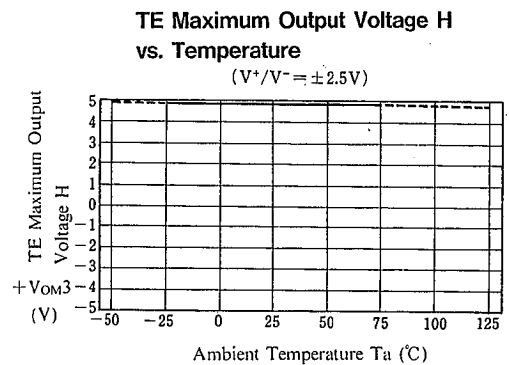
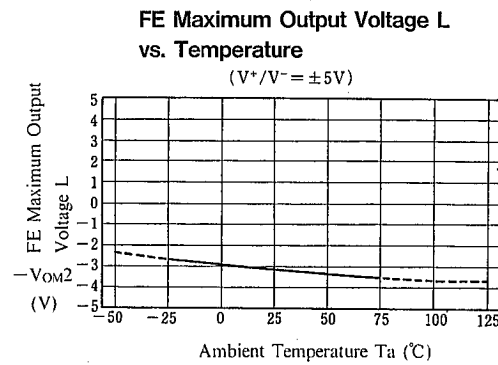
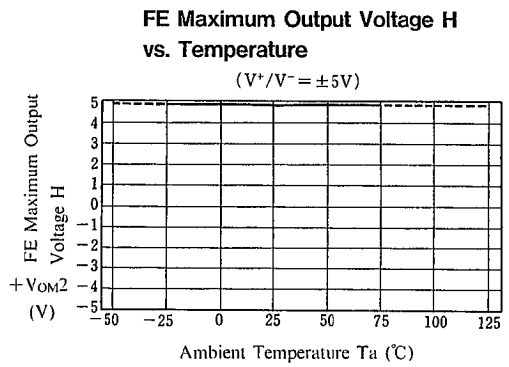
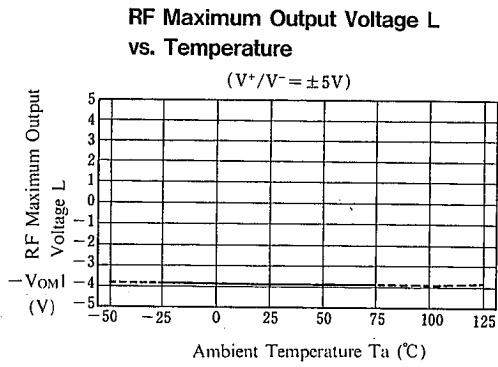
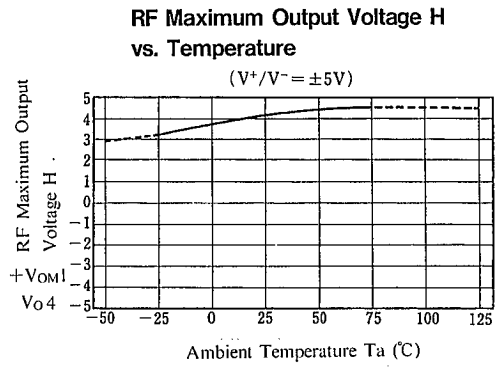
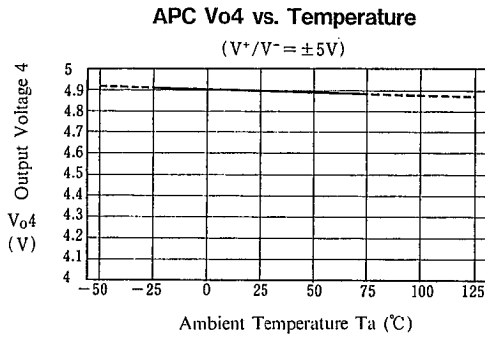

■ TYPICAL CHARACTERISTICS

TE Maximum Output Voltage L vs. Temperature
($V^+/V^- = \pm 2.5V$)

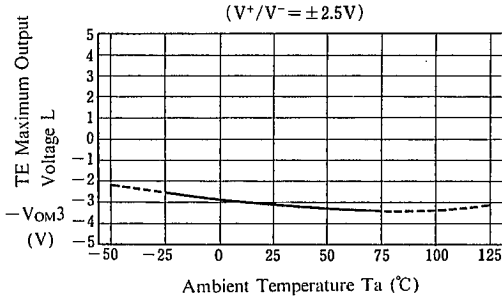

Operating Current(I_{cc}) vs. Operating Voltage

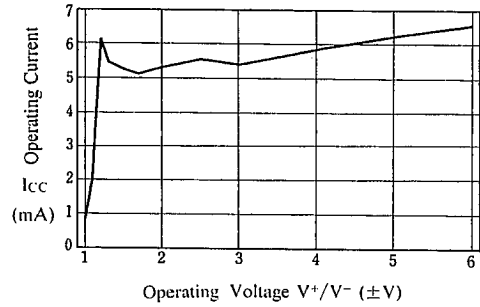

Operating Current(I_{EE}) vs. Operating Voltage

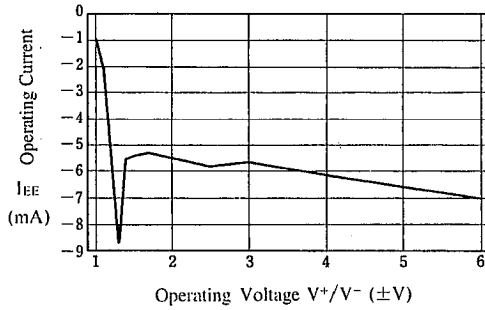

RF Maximum Output Voltage vs. Operating Voltage

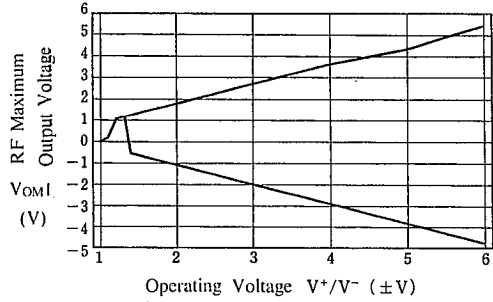

FE Maximum Output Voltage vs. Operating Voltage

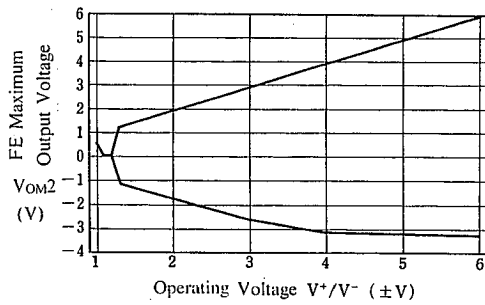

TE Maximum Output Voltage vs. Operating Voltage

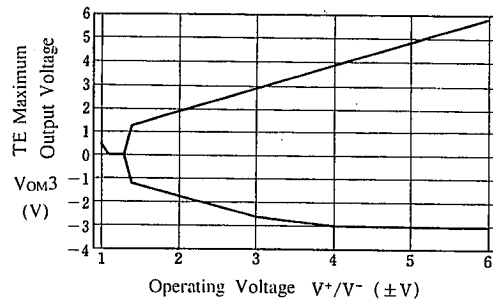

5

■ TYPICAL CHARACTERISTICS

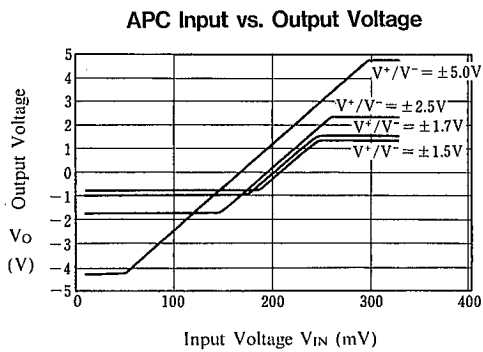

5

MEMO

[CAUTION]

The specifications on this databook are only given for information, without any guarantee as regards either mistakes or omissions. The application circuits in this databook are described only to show representative usages of the product and not intended for the guarantee or permission of any right including the industrial rights.