

3-INPUT VIDEO SUPER IMPOSER WITH 75Ω DRIVER

■ GENERAL DESCRIPTION

NJM2263 is 3-input, 1-output video switch with 75Ω driver circuit.

Two input are provided with sink chip clamp function, which adjust the DC level of video signal.

The other input of transistor open base can make control of luminance signal.

This video switch can be connected to TV monitor directly, as it has 75Ω driver circuit internally. NJM2263 is a high performance video switch with 10MHz frequency range and 70dB (at 4.43MHz) crosstalk, which is operated with 5V supply voltage.

■ FEATURES

- Wide Operating Voltage (4.75~13V)
- 3 Input, 1 - Output
- Internal 75Ω Driver Circuit
- Internal Sink Chip Clamp Function (V_{in1} , V_{in2})
- Internal luminance Signal Control Function (V_{in3})
- Crosstalk 70dB(at 4.43MHz)
- Wide Operating Frequency Range 10MHz(2V_{r-p} input)
- Package Outline DIP8, DMP8, SIP8
- Bipolar Technology

■ APPLICATIONS

- VCR, Video Camera, AV-TV, Video Disc Player.

■ BLOCK DIAGRAM

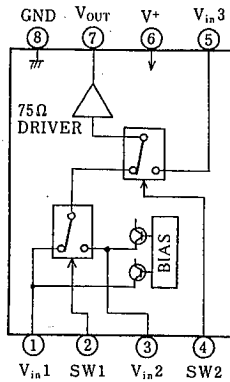

■ PACKAGE OUTLINE

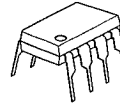

NJM2263D



NJM2263M

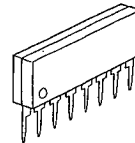

NJM2263L

■ ABSOLUTE MAXIMUM RATINGS

(Ta=25°C)

PARAMETER	SYMBOL	RATINGS	UNIT
Supply Voltage	V*	15	V
Power Dissipation	Pd	(DIP8) 500	mW
		(DMP8) 300	mW
		(SIP8) 800	mW
Operating Temperature Range	T _{opr}	-20~+75	°C
Storage Temperature Range	T _{stg}	-40~+125	°C

■ ELECTRICAL CHARACTERISTICS

(V*=5V, Ta=25±2°C)

PARAMETERS	SYMBOLS	TEST CONDITIONS	MIN.	TYP.	MAX.	UNIT.
Recommended Supply Voltage	V+		4.75	—	13.0	V
Operating Current	I _{CC}	S1=S2=S3=S4=S5=2	—	16.5	23.0	mA
Voltage Gain	G _v	V _{in} =2.0V _{p-p} , 100kHz V _o /V _i	-0.8	-0.3	+0.2	dB
Frequency Characteristics	G _r	V _{in} =2.0V _{p-p} , V _o (10MHz)/V _o (100kHz)	-1.0	0	+1.0	dB
Differential Gain	DG	V _{in} =2.0V _{p-p} , Staircase, R _L =150Ω	—	0.3	—	%
Differential Phase	DP	V _{in} =2.0V _{p-p} , Staircase, R _L =150Ω	—	0.3	—	deg
Output Offset Voltage	V _{OS}	S1=S2=S3=2, S4=2 → 1	-30	0	+30	mV
Crosstalk	CT	V _i =2.0V _{p-p} , 4.43MHz	—	-70	—	dB
		V _o /V _i	—	—	—	dB
		V _{in3} Biased (note 2)	2.4	—	—	dB
Switch change Voltage	V _{CH}	Switch High Level Voltage	—	—	—	V
	V _{CL}	Switch Low Level Voltage	—	—	0.8	V

Note 1) Unless otherwise specified, tested with the following conditions.

a) S1=1 S2=S3=S4=S5=2 b) S2=S4=1, S1=S3=S5=2 c) S3=S5=1, S1=S2=1, S4=1 or 2

Note 2) Tested with the following conditions.

a) S1=S4=1, S2=S3=2, S5=1 and 2 b) S2=1, S1=S3=S4=2, S5=1 and 2 c) S3=1, S1=S2=S5=2, S4=1 and 2

Note 3) The Clamp Input Voltage of Vin 1 and Vin 2 is approximately, (2×V*)/5. (In case of V*=5V, about 20V)

■ SWITCH CONTROL SIGNAL-OUTPUT SIGNAL

SW 1	SW 2	OUTPUT SIGNAL
L	L	V _{in1}
H	L	V _{in2}
L/H	H	V _{in3}

■ TEST CIRCUIT

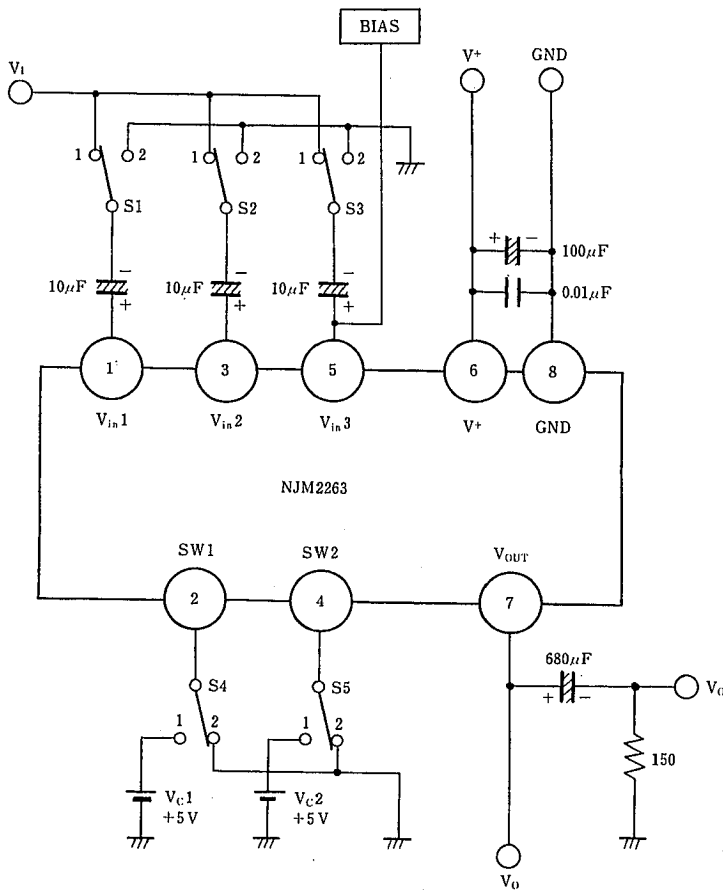

■ APPLICATION

Oscillation Prevention on light loading conditions
Recommended under circuit

This IC requires 1MΩ resistance between INPUT and GND pin for clamp type input since the minute current causes an unstable pin voltage.

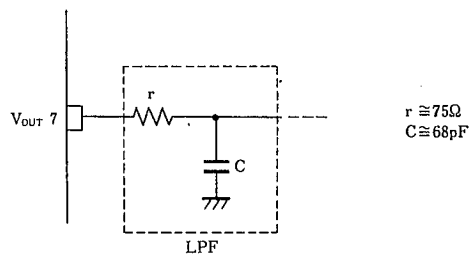

■ EQUIVALENT CIRCUIT

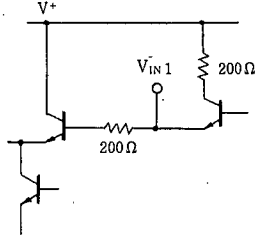
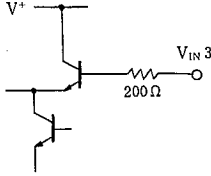
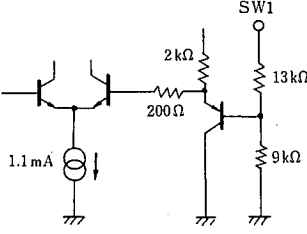
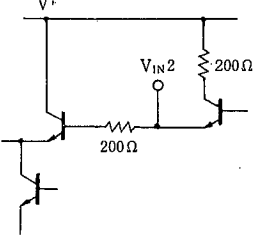
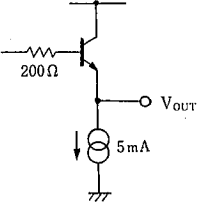
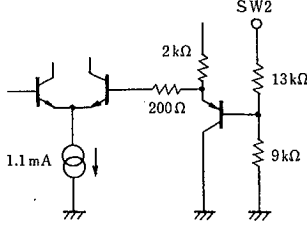
PIN NO.	PIN FUNCTION	INSIDE EQUIVALENT CIRCUIT	PIN NO.	PIN FUNCTION	INSIDE EQUIVALENT CIRCUIT
1	V _{IN 1}		5	V _{IN 3}	
2	SW 1		6	V ⁺	_____
3	V _{IN 2}		7	V _{OUT}	
4	SW 2		8	GND	_____

5

MEMO

[CAUTION]

The specifications on this databook are only given for information, without any guarantee as regards either mistakes or omissions. The application circuits in this databook are described only to show representative usages of the product and not intended for the guarantee or permission of any right including the industrial rights.