

5-INPUT 3-OUTPUT VIDEO SWITCH

■ GENERAL DESCRIPTION

The NJM2296 is a 5-input 3-output video switch. Its switches select one from five signals received from VCR, TV, Video Disk Player and others. This IC is designed for audio items, such as AV amplifier and receivers, and others.

■ PACKAGE OUTLINE

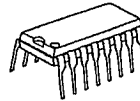

NJM2296D

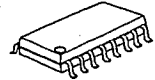

NJM2296M

■ FEATURES

- 5-input 3-output
- Operating Voltage (±4.0V~±6.5V)
- Crosstalk (-65dB typ.)
- Bipolar Technology
- Package Outline DIP16, DMP16

■ PIN CONFIGURATION AND BLOCK DIAGRAM

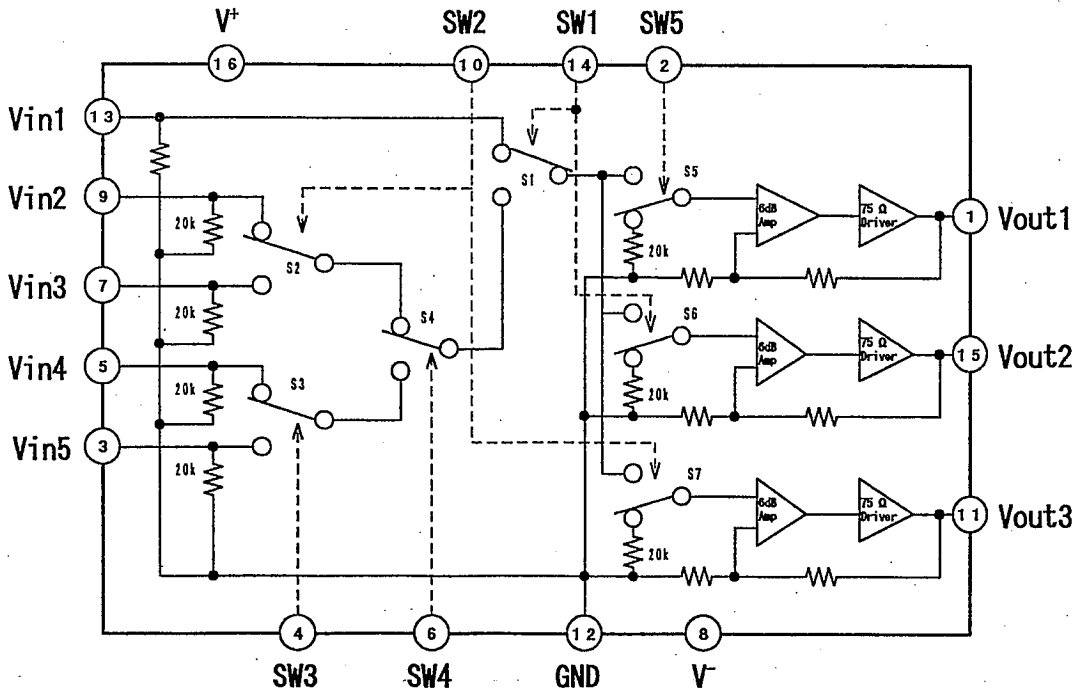

5

■ ABSOLUTE MAXIMUM RATINGS

(Ta=25°C)

PARAMETER	SYMBOL	RATINGS	UNIT
Supply Voltage	V ⁺ /V ⁻	±7	V
Power Dissipation	P _D	(DIP16) 700 (DMP16) 700 (note)	mW
Operating Temperature Range	T _{OPR}	-20 ~ +75	°C
Storage Temperature Range	T _{STG}	-40 ~ +150	°C

(note) At on a Glass epoxy board (70×70×1.6mm)

■ ELECTRICAL CHARACTERISTICS (Ta=25°C, V⁺/V⁻=±5V, R_L=150Ω)

PARAMETER	SYMBOL	TEST CONDITION	MIN.	TYP.	MAX.	UNIT
Positive Operating Current	I _{CC}	No signal	—	31.0	—	mA
Negative Operating Current	I _{EE}	No signal	—	-31.0	—	mA
Voltage Gain	G _V	V _{IN} =100kHz/1.0Vpp	6.0	6.3	6.8	dB
Frequency Characteristic	G _f	5MHz/100kHz, 1Vpp	-1.0	0.0	+1.0	dB
Differential Gain	DG	V _{IN} =1Vpp, Stair wave	—	0.2	—	%
Differential Phase	DP	V _{IN} =1Vpp, Stair wave	—	0.2	—	deg
Offset Output Voltage ₁	V _{OS1}	No Signal, Vin2-Vin3間	-40.0	0.0	+40.0	mV
Offset Output Voltage ₂	V _{OS2}	No Signal, Vin1-Vin2, Vin-Vin3	-60.0	0.0	+60.0	mV
Input Crosstalk	CT	V _{IN} =4.43MHz/1Vpp, V _O /V _{IN}	—	-65.0	—	dB
Mute Crosstalk	CTM	V _{IN} =4.43MHz/1Vpp, V _O /V _{IN}	—	-55.0	—	dB
Switch Change Voltage	V _{CH}		3.0	—	V ⁺	V
	V _{CL}		0.0	—	1.0	V
Total Harmonic Distortion	THD	V _{IN} =1kHz/1.25Vpp	—	0.1	—	%
Input Impedance	R _{IN}		—	20.0	—	KΩ

5

CONTROL SIGNAL - OUTPUT SIGNAL

(L=V_{CL}, H=V_{CH}, X=LorH)

SW 1	SW 2	SW 3	SW 4	SW 5	Vout 1	Vout 2	Vout 3
L	H	x	x	H	Vin1	mute	Vin1
	L			Vin1	mute	mute	
	H			mute	mute	Vin1	
H	L	x	L	H	Vin2	Vin2	mute
				L	mute	Vin2	mute
H	H	x	L	H	Vin3	Vin3	Vin3
				L	mute	Vin3	Vin3
H	H	L	H	H	Vin4	Vin4	Vin4
	H			mute	Vin4	Vin4	
	L			Vin4	Vin4	mute	
	L			mute	Vin4	mute	
H	H	H	H	H	Vin5	Vin5	Vin5
	H			mute	Vin5	Vin5	
	L			Vin5	Vin5	mute	
	L			mute	Vin5	mute	
L	L	x	x	L	mute	mute	mute

TEST CIRCUIT

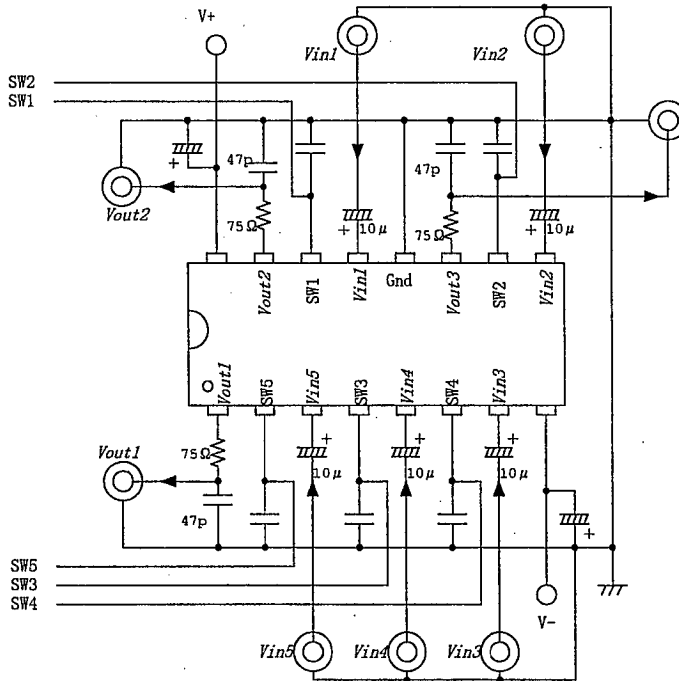

5

■ TYPICAL CHARACTERISTICS

Operating Current vs. Temperature

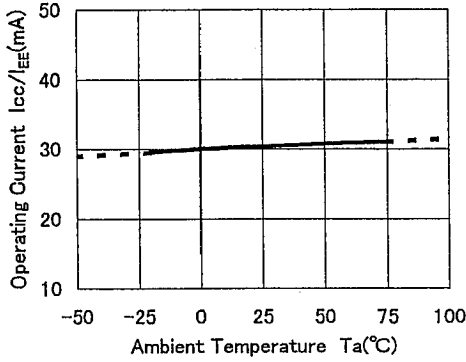

Voltage Gain vs. Temperature

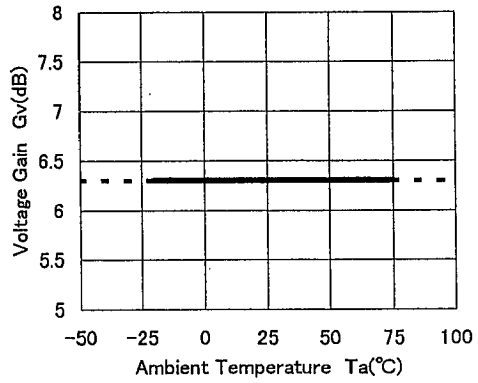

Frequency Characteristic vs. Temperature

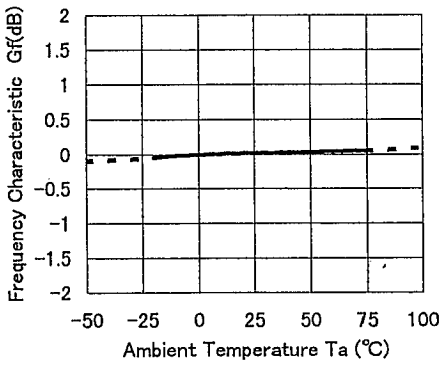

Differential Gain vs. Temperature

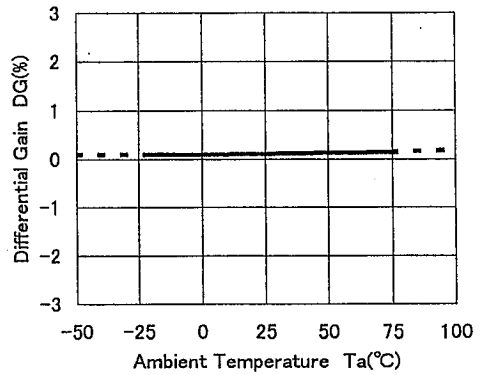

Differential Phase vs. Temperature

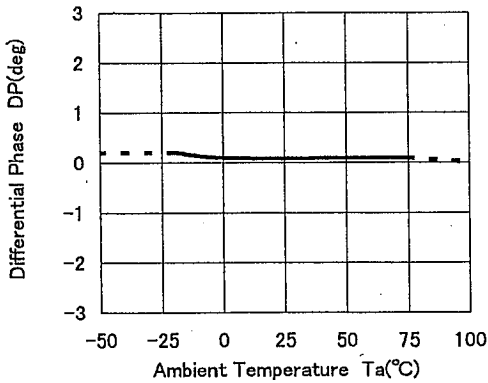

Total Harmonic Distortion vs. Temperature
($V_{in}=1\text{kHz}/1.25\text{Vpp}$)

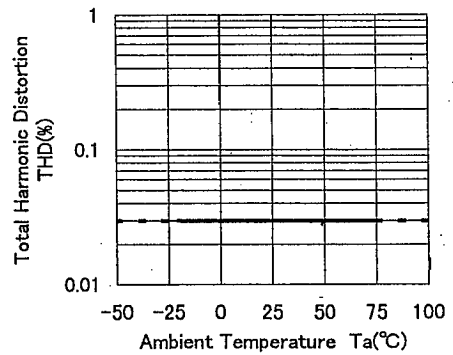

5

TYPICAL CHARACTERISTICS

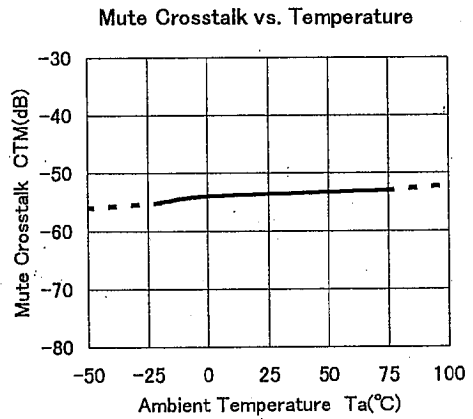
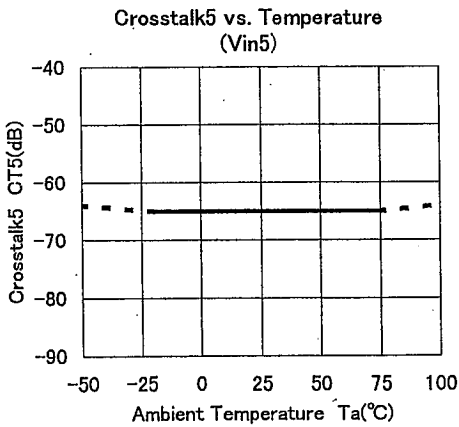
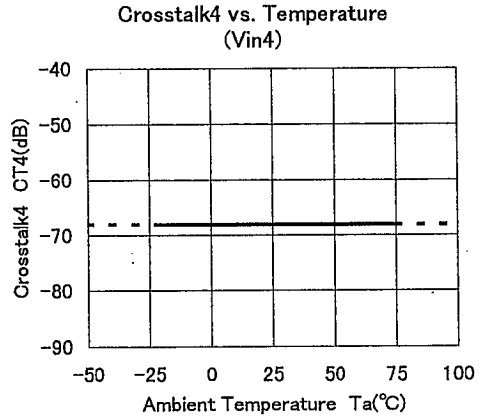
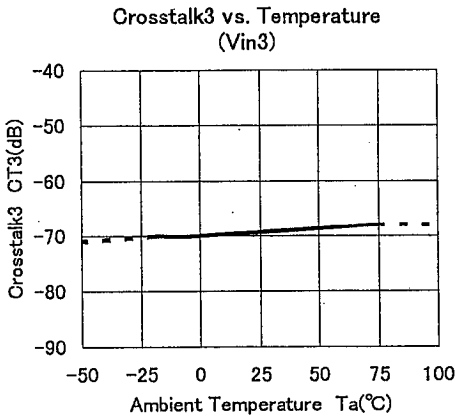
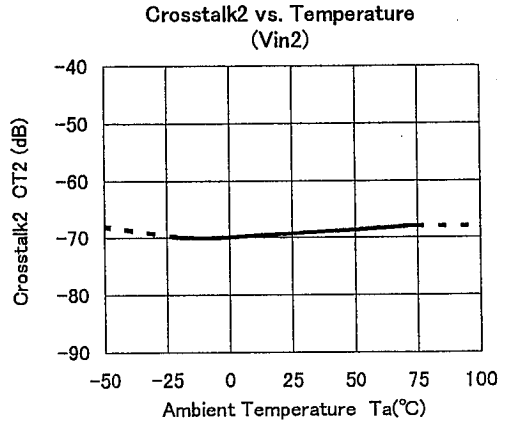
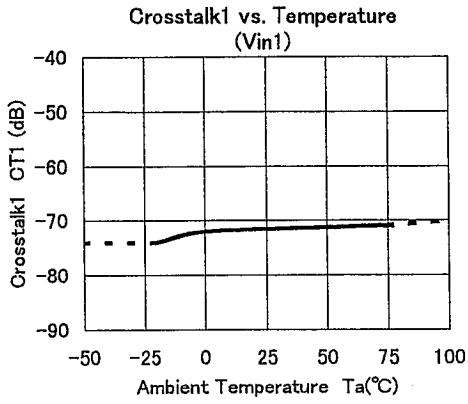

■ TYPICAL CHARACTERISTICS

Output Offset Voltage 1 vs. Temperature
(No Signal, $V_{in2} \rightarrow V_{in3}$)

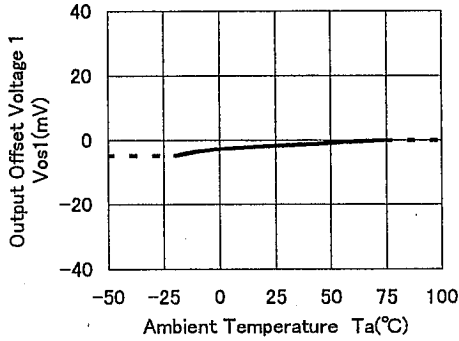

Output Offset Voltage 2 vs. Temperature
(No Signal, $V_{in1} \rightarrow V_{in2}$)

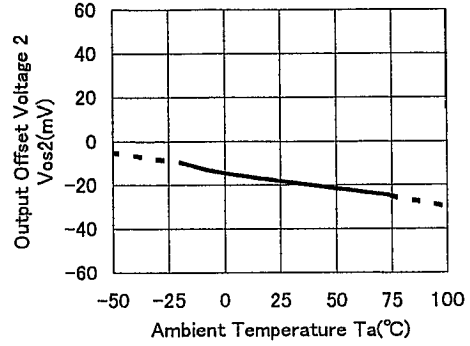

Operating Current vs. Supply Voltage

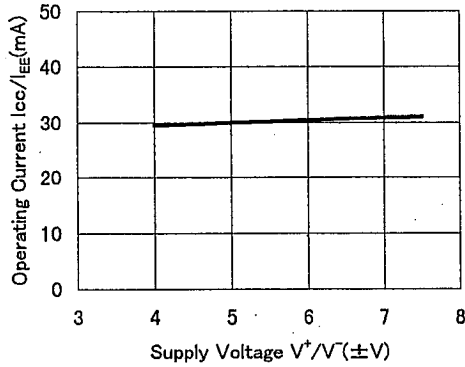

Differential Gain vs. Supply Voltage

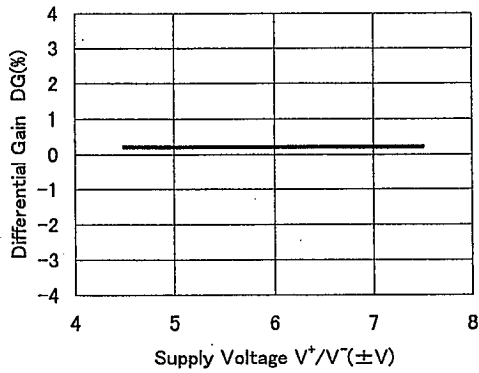

Differential Phase vs. Supply Voltage

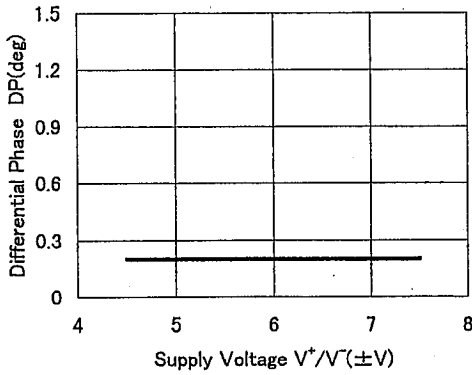

Total Harmonic Distortion vs. Supply Voltage
($V_{in}=1\text{kHz}/1.25V_{pp}$)

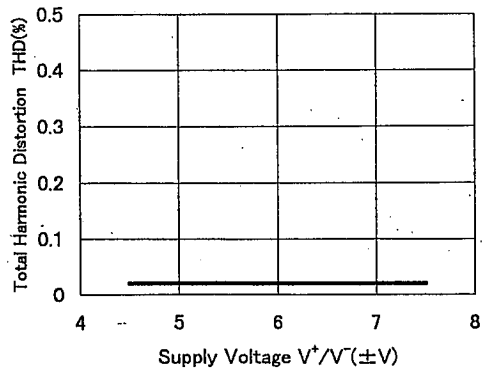

5

TYPICAL CHARACTERISTICS

Switching Voltage(High) vs. Supply Voltage

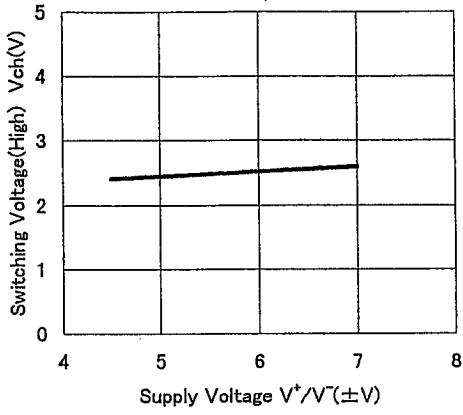

Switching Voltage(Low) vs. Supply Voltage

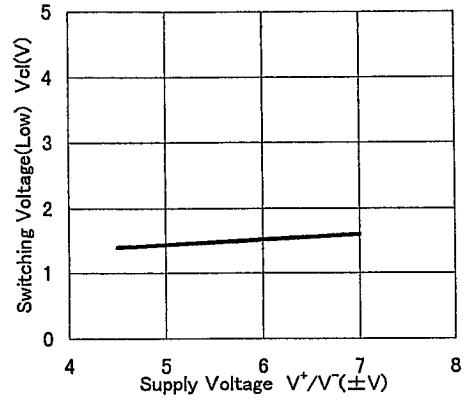

MEMO

[CAUTION]

The specifications on this databook are only given for information, without any guarantee as regards either mistakes or omissions. The application circuits in this databook are described only to show representative usages of the product and not intended for the guarantee or permission of any right including the industrial rights.