

PWM SWITCHING REGULATOR CONTROL IC FOR SLAVE TYPE

■ GENERAL DESCRIPTION

The NJM2378 is a high speed switching regulator control IC, and directly drive an external Bipolar Transistor to use internal totempole output circuit.

The NJM2378 operate slave mode which synchronous external oscillation frequency, and the slave mode reduce the total noise.

The NJM2378 is suitable for flyback type switching regulation up to 10W and several output power supply for LCD panel.

■ PACKAGE OUTLINE

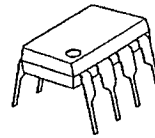

NJM2378D



NJM2378M



NJM2378E



NJM2378V

■ FEATURES

- Operating Voltage (3.6~32V)
- Reference Voltage (2.5V±2%)
- Input Outside
 - Oscillator Frequency (5~350 kHz)
- Output Switch Current (±8mA min.)
- Under Voltage Lockouts Circuit
- Bipolar Technology
- Package Outline DIP8, DMP8, EMP8, SSOP8

■ BLOCK DIAGRAM

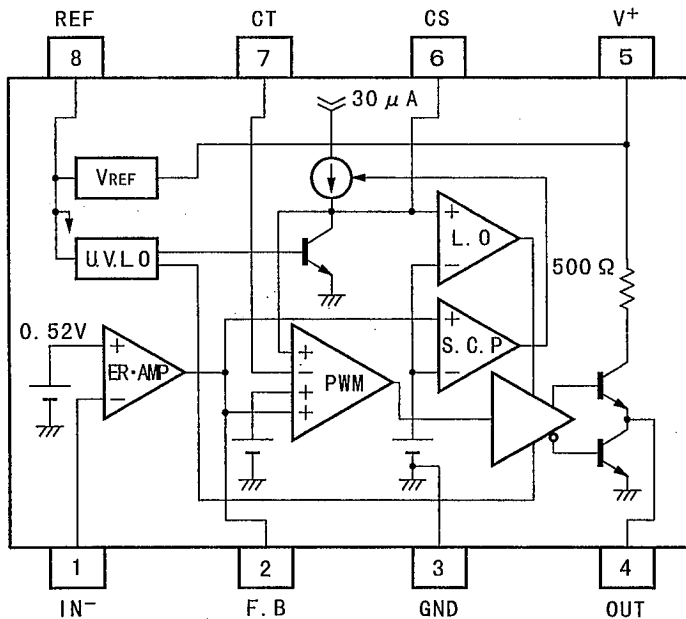

PIN FUNCTION

1. IN⁻
2. F. B
3. GND
4. OUT
5. V⁺
6. CS
7. CT
8. REF



NJM2378

■ ABSOLUTE MAXIMUM RATINGS (Ta=25°C)

PARAMETER	SYMBOL	RATINGS	UNIT
Supply Voltage	V^+	36	V
Reference Output Current	I_{OR}	10	mA
Output Current	I_o	± 50	mA
CT Pin Voltage	V_{CT}	1.5	V
Power Dissipation	P_D	(DIP8) 700 (DMP8) 300 (EMP8) 300 (SSOP8) 250	mW
Operating Temperature Range	T_{OPR}	-40~+85	°C
Storage Temperature Range	T_{STG}	-50~+125	°C

■ RECOMMENDED OPERATING CONDITIONS (V⁺=6V, Ta=25°C)

PARAMETER	SYMBOL	MIN.	MAX.	UNIT
Operating Voltage	V^+	3.6	32	V
Feed Back Resistor	R_{NF}	100	—	k Ω
Oscillate	f_{OSC}	5	350	kHz

INPUT WAVEFORME

PARAMETER	SYMBOL	RECOMMENDED	UNIT
Triangle Waveform	V_{P-P}	0.5	V
Offset Voltage	V_{OFFSET}	0.5	V

6

■ ELECTRICAL CHARACTERISTICS

($V^+=6V$, $R_T=33k\Omega$, $C_T=1000pF$, $T_a=25^\circ C$ OSC: Triangle Waveform, $V_{P-P}=0.5V$, Offset=0.5V, $f_{osc}=100kHz$)
 REFERENCE VOLTAGE BLOCK

PARAMETER	SYMBOL	TEST CONDITION	MIN.	TYP.	MAX.	UNIT
Output Voltage	V_{REF}	$I_{OR}=1mA$	2.45	2.50	2.55	V
Line Regulation	L_{INE}	$V^+=3.6\sim 32V$, $I_{OR}=1mA$	—	6.8	20.7	mV
Load Regulation	L_{OAD}	$I_{OR}=0.1\sim 5.0mA$	—	5	30	mV

OSCILLATOR BLOCK

PARAMETER	SYMBOL	TEST CONDITION	MIN.	TYP.	MAX.	UNIT
Reference Voltage	V_B		0.51	0.52	0.53	V
Input Bias Current	I_B		—	5	100	nA
Open Loop Gain	A_V		—	90	—	dB
Gain Band width Product	G_B		—	0.6	—	MHz
Maximum Output Voltage (F.B Pin)	V_{OM+} V_{OM-}	$R_{NF}=100k\Omega$ $R_{NF}=100k\Omega$	$V_{REF}-0.2$ —	—	— 200	V mV
Output Source Current	I_{OM+}	$V_{OM}=1V$	40	85	200	μA

PWM COMPARATOR BLOCK

PARAMETER	SYMBOL	TEST CONDITION	MIN.	TYP.	MAX.	UNIT
Triangle Waveform Input Minimum Voltage (CT Pin)	OSC_{LO}	CT Pin Triangle Waveform Input	0	—	0.4	V
Triangle Waveform Input Maximum Voltage (CT Pin)	OSC_{HI}	CT Pin Triangle Waveform Input	0.7	—	1.3	V
Input Threshold Voltage (F.B Pin)	V_{TH0}	duty·cycle=0%	—	0.55	0.65	V
Input Threshold Voltage (F.B Pin)	V_{TH50}	duty·cycle=50%	—	0.87	—	V
Maximum Duty Cycle	αM	F.B Pin=1.2V	55	64	85	%

SOFT START CIRCUIT BLOCK

PARAMETER	SYMBOL	TEST CONDITION	MIN.	TYP.	MAX.	UNIT
Input Bias Current (CS Pin)	I_{BCS}		—	250	650	nA
Input Threshold Voltage (CS Pin)	V_{THCS0}	duty·cycle=0%	—	0.25	0.35	V
Input Threshold Voltage (CS Pin)	V_{THCS50}	duty·cycle=50%	—	0.52	—	V

6

■ ELECTRICAL CHARACTERISTICS

($V^+=6V$, $R_T=33k\Omega$, $C_T=1000pF$, $T_a=25^\circ C$ OSC: Triangle Waveform, $V_{P-P}=0.5V$, OFFSET=0.5V, $f_{OSC}=100kHz$)
 SHORT CIRCUIT PROTECTION

PARAMETER	SYMBOL	TEST CONDITION	MIN.	TYP.	MAX.	UNIT
Input Threshold Voltage (F. B Pin)	V_{THPC}		1.20	1.50	1.80	V
Charge Current (CS Pin)	I_{CHG}	CS Pin=0V, F. B Pin=2V	10	30	50	μA
Latch mode Threshold Voltage (CS Pin)	V_{THLA}		1.20	1.50	1.80	V

UNDER VOLTAGE LOCKOUT

PARAMETER	SYMBOL	TEST CONDITION	MIN.	TYP.	MAX.	UNIT
ON Threshold Voltage	V_{THON}		—	2.70	—	V
OFF Threshold Voltage	V_{THOFF}		—	2.52	—	V
Hysteresis Voltage	V_{HYS}		60	180	—	mV

OUTPUT

PARAMETER	SYMBOL	TEST CONDITION	MIN.	TYP.	MAX.	UNIT
H-Output Voltage (OUT Pin)	V_{OH}	$R_L=10k\Omega$	3.50	4.00	—	V
L-Output Voltage (OUT Pin)	V_{OL}	Output Sink Current=20mA	—	0.25	0.65	V
Output Source Current (OUT Pin)	I_{SOURCE}	OUT Pin=0V	8	11	—	mA

GENERAL CHARACTERISTICS

PARAMETER	SYMBOL	TEST CONDITION	MIN.	TYP.	MAX.	UNIT
Quiescent Current	I_{CCLA}	Latch Mode	—	1.6	2.2	mA
Average Quiescent Current	I_{CCAV}	$R_L=\infty$, duty cycle=50%	—	3.5	4.8	mA

6

■ TYPICAL APPLICATIONS

Synchronous mode with NJM2368

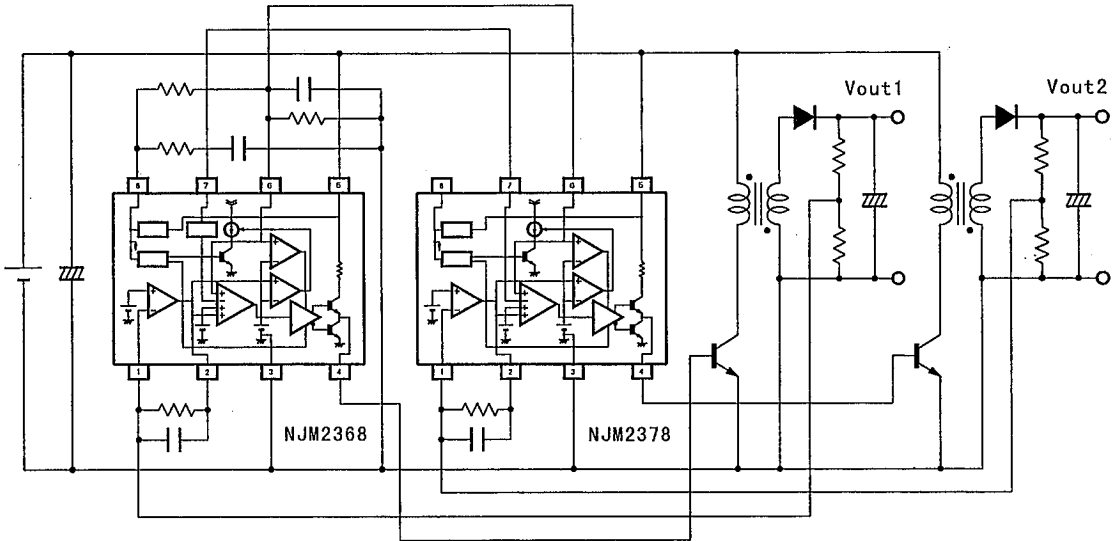

External pulse mode

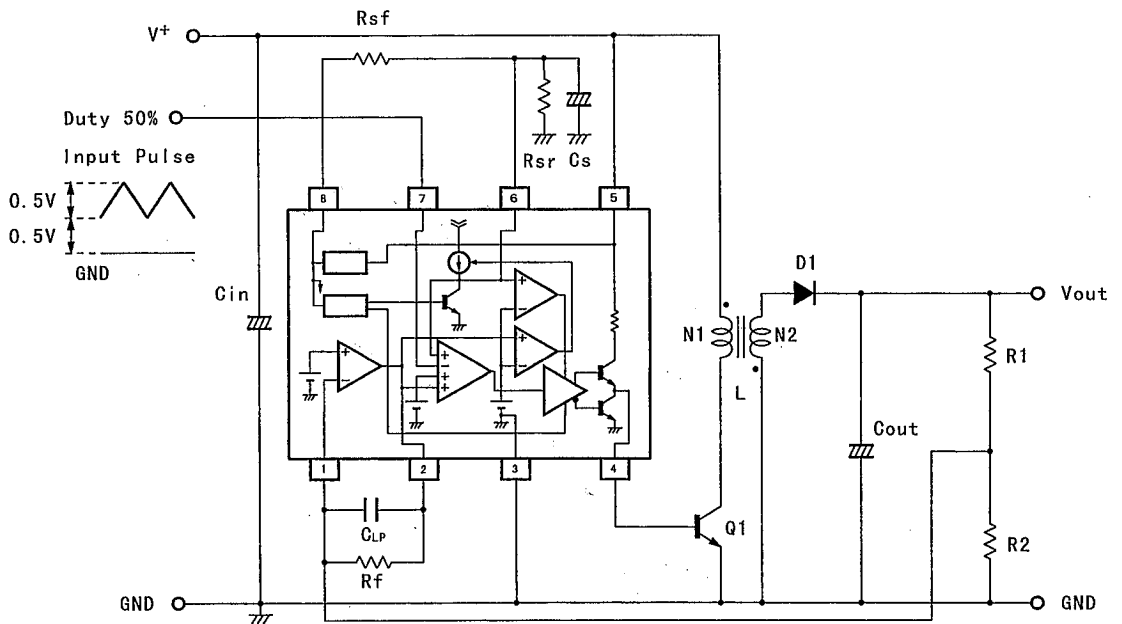

6

TYPICAL CHARACTERISTICS

H Output Voltage(OUT Pin) vs. Source Current
 ($V^+=6V, OUT\ Pin=0V, OSC: Triangle\ Waveform$
 $V_{P-P}=0.5V, Offset=0.5V, f_{osc}=100kHz, T_a=25^\circ C$)

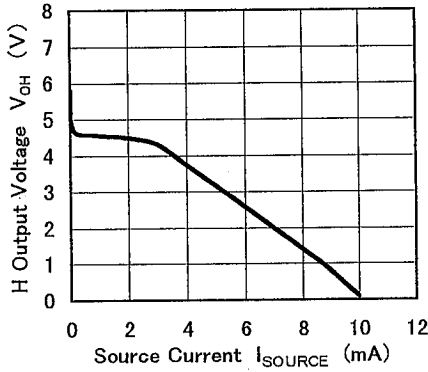

L Output Voltage(OUT Pin) vs. Sink Current
 ($V^+=6V, OSC: Triangle\ Waveform$
 $V_{P-P}=0.5V, Offset=0.5V, f_{osc}=100kHz, T_a=25^\circ C$)

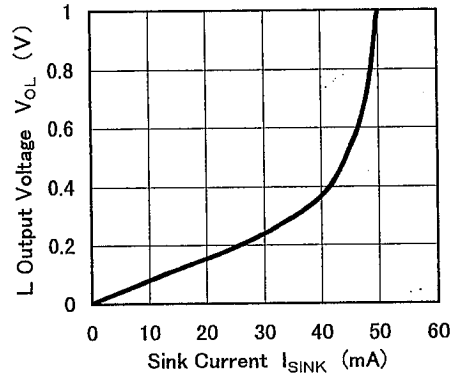

Reference Voltage vs. Operating Voltage
 ($T_a=25^\circ C$)

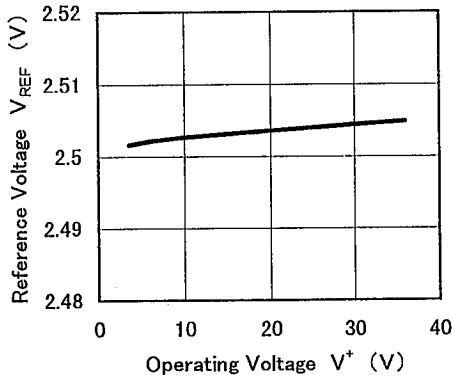

Operating Current vs. Operating Voltage
 ($T_a=25^\circ C$)

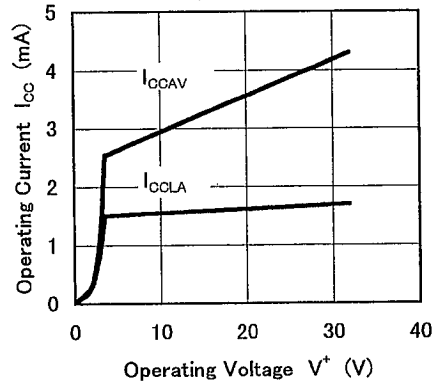

■ TYPICAL CHARACTERISTICS

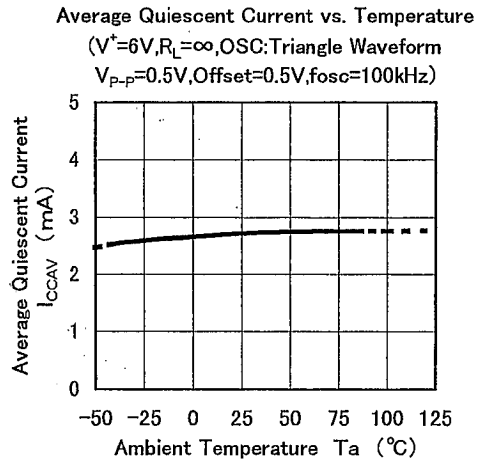
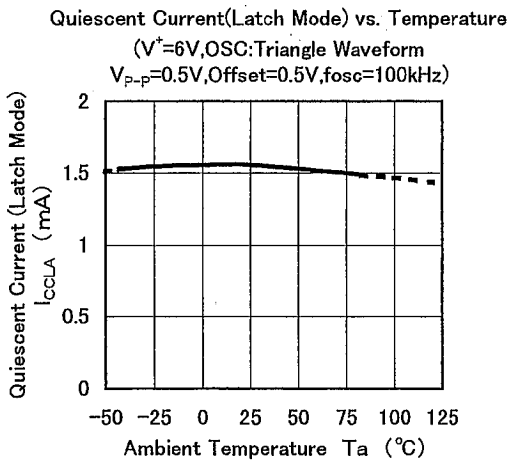
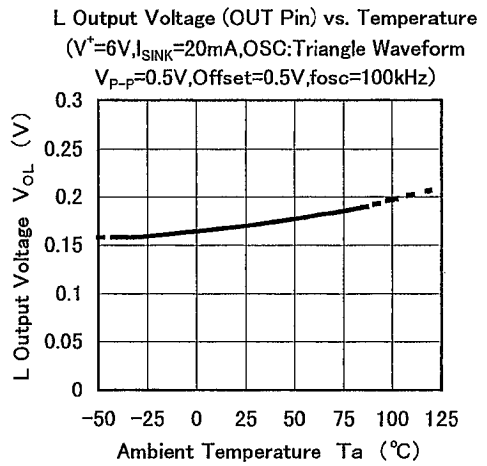
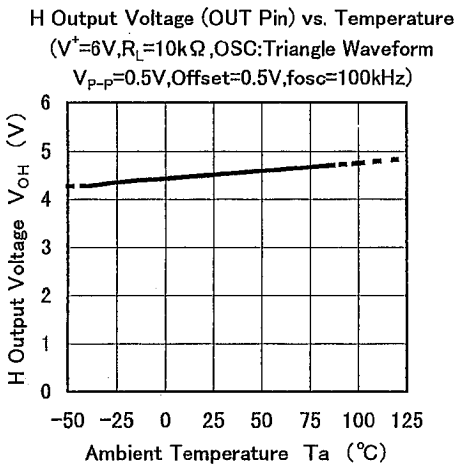
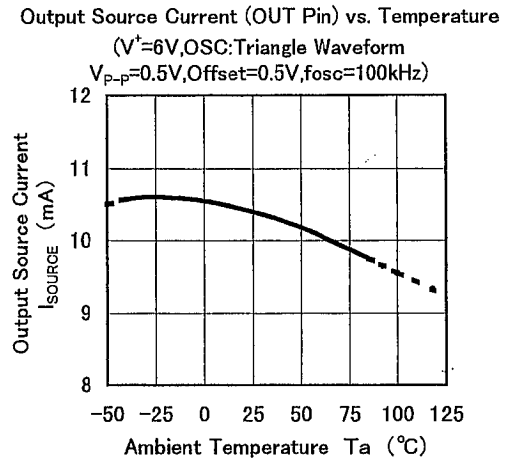
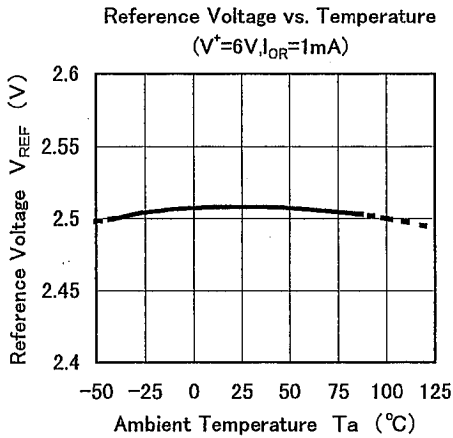

6

MEMO

[CAUTION]

The specifications on this databook are only given for information, without any guarantee as regards either mistakes or omissions. The application circuits in this databook are described only to show representative usages of the product and not intended for the guarantee or permission of any right including the industrial rights.