

SINGLE-SUPPLY DUAL COMPARATOR

■ GENERAL DESCRIPTION

The NJM2903/2403 consist of two independent precision voltage comparators with an offset voltage specification as low as 5.0mV max for two comparators which were designed specifically to operate from a single power supply over a wide range of voltages. Operation from split power supplies is also possible and the low power supply current drain is independent of the magnitude of the power supply voltage. The NJM2903/2403 has a unique characteristics: the input common-mode voltage range includes ground, even though operated from a single power supply voltage. Application areas include limit comparators, simple analog-to-digital converters; pulse, square-wave and time delay generators; wide range V<sub>CO</sub>; MOS clock timers; multivibrators and high voltage digital logic gates. The NJM2903/2403 were designed to directly interface with TTL and CMOS. When operated from both plus and minus power supplies, the NJM2903/2403 will directly interface with MOS logic where their low power drain is a distinct advantage over standard comparators.

■ PACKAGE OUTLINE

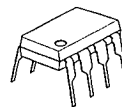

NJM2903D/2403D



NJM2903M/2403M

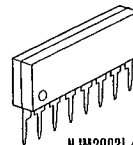

NJM2903L/2403L



NJM2903V  
NJM2403V

■ FEATURES

- Operating Voltage ( +2V ~ +36V )
- Single Supply Operation
- Open Collector Output
- High Output Sink Current ( 15mA @2403 )
- Package Outline DIP8, DMP8, SIP8, (SSOP8)
- Bipolar Technology

■ PIN CONFIGURATION

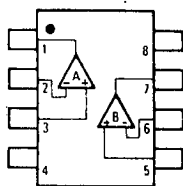

NJM2903D/2403D  
NJM2903M/2403M  
NJM2903V/2403V

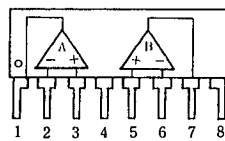

NJM2903L/2403L

PIN FUNCTION

1. A OUTPUT
2. A-INPUT
3. A+INPUT
4. GND
5. B+INPUT
6. B-INPUT
7. B OUTPUT
8. V<sub>C</sub>

■ EQUIVALENT CIRCUIT (1/2 Shown)

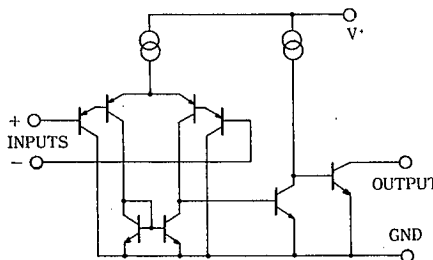

■ ABSOLUTE MAXIMUM RATINGS

(Ta=25°C)

PARAMETER	SYMBOL	RATINGS	UNIT
Supply Voltage	V*	36(or ±18)	V
Differential Input Voltage	V <sub>ID</sub>	36	V
Input Voltage	V <sub>IN</sub>	-0.3~+36	V
Power Dissipation	P <sub>D</sub>	(DIP8) 500	mW
		(DMP8) 300	mW
		(SSOP8) 250	mW
		(SIP8) 800	mW
Operating Temperature Range	T <sub>opr</sub>	-40~+85	°C
Storage Temperature Range	T <sub>stg</sub>	-50~+125	°C

■ ELECTRICAL CHARACTERISTICS

(V<sup>+</sup>=5V, Ta=25°C)

PARAMETER	SYMBOL	TEST CONDITION	2903			2403			UNIT
			MIN.	TYP.	MAX.	MIN.	TYP.	MAX.	
Input Offset Voltage	V <sub>IO</sub>	R <sub>S</sub> = 0Ω, V <sub>O</sub> ≅ 1.4V	—	—	7	—	—	10	mV
Input Offset Current	I <sub>IO</sub>		—	—	50	—	—	100	nA
Input Bias Current	I <sub>B</sub>		—	30	250	—	40	500	nA
Input Common Mode Voltage Range	V <sub>ICM</sub>		0~3.5	—	—	0~3.5	—	—	V
Large Signal Voltage Gain	A <sub>V</sub>	R <sub>L</sub> = 15kΩ	—	106	—	—	106	—	dB
Response Time	t <sub>R</sub>	R <sub>L</sub> 5.1kΩ	—	1.5	—	—	1.5	—	μS
Output Sink Current	I <sub>SINK</sub>	V <sub>IN</sub> <sup>-</sup> = 1V, V <sub>IN</sub> <sup>+</sup> = 0V, V <sub>O</sub> = 1.5V	6	—	—	20	—	—	mA
Output Saturation Voltage	V <sub>SAT</sub>	V <sub>IN</sub> <sup>-</sup> = 1V, V <sub>IN</sub> <sup>+</sup> = 0V <sub>m</sub> , I <sub>SINK</sub> = 3mA	—	200	400	—	—	—	mV
Output Saturation Voltage	V <sub>SAT</sub>	V <sub>IN</sub> <sup>-</sup> = 1V, V <sub>IN</sub> <sup>+</sup> = 0V, I <sub>SINK</sub> = 15mA	—	—	—	—	200	400	mV
Output Leakage Current	I <sub>LEAK</sub>	V <sub>IN</sub> <sup>-</sup> = 0V, V <sub>IN</sub> <sup>+</sup> = 0V, V <sub>O</sub> = 5V	—	—	1.0	—	—	1.0	μA
Operating Current	I <sub>CC</sub>		—	0.4	1.0	—	0.5	1.5	mA

5

## TYPICAL CHARACTERISTICS

**Input Bias Current vs. Temperature**  
( $V^+ = 5\text{ V}$ )

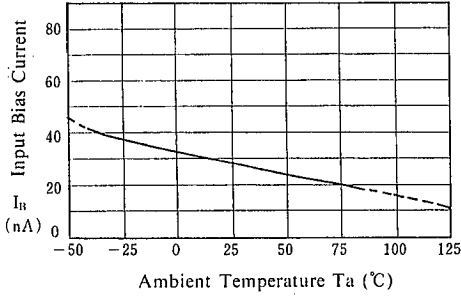

**Input Offset Voltage vs. Temperature**  
( $V^+ = 5\text{ V}$ )

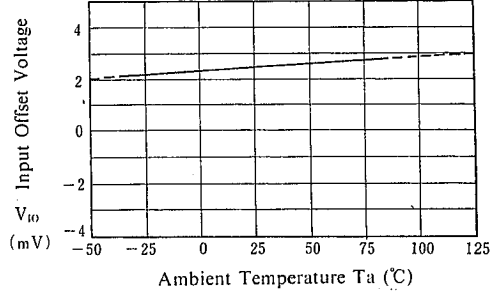

**Operating Current vs. Operating Voltage**  
( $T_a = 25^\circ\text{C}$ )

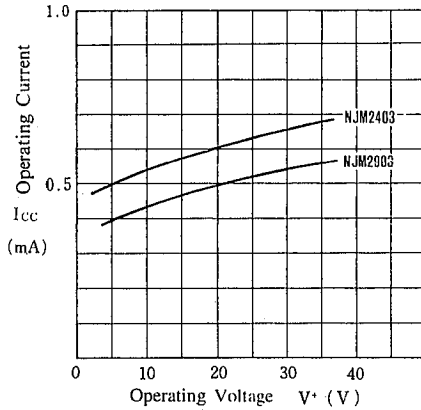

**Input Bias Current vs. Operating Voltage**  
( $T_a = 25^\circ\text{C}$ )

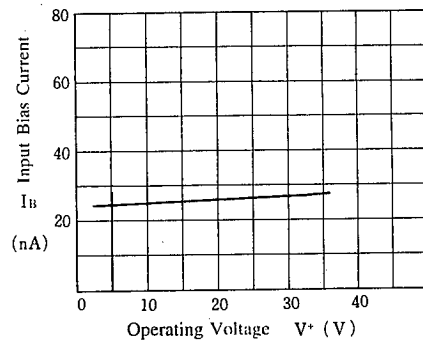

**NJM2903 Output Saturation Voltage vs. Output Sink Current**

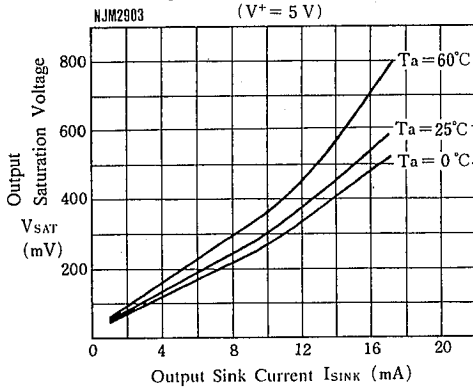

**NJM2403 Output Saturation Voltage vs. Output Sink Current**

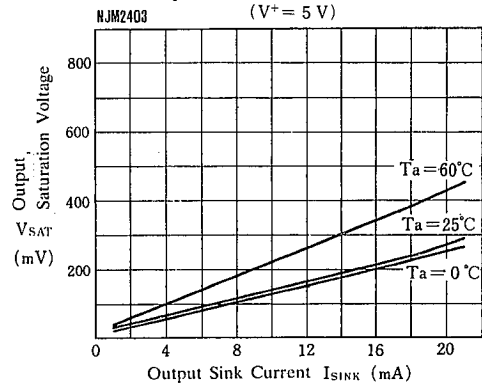

■ TYPICAL CHARACTERISTICS

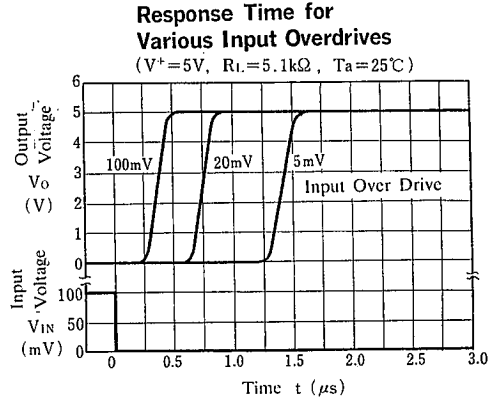

**NJM2903 Output Saturation Voltage vs. Operating Voltage**

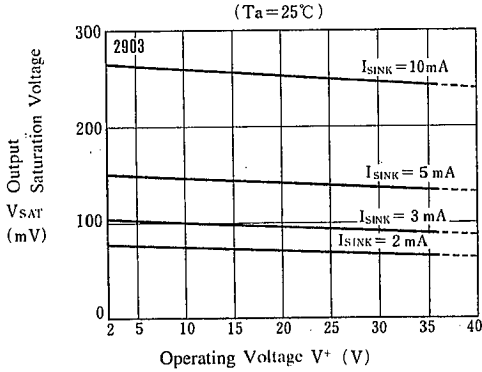

**NJM2403 Output Saturation Voltage vs. Operating Voltage**

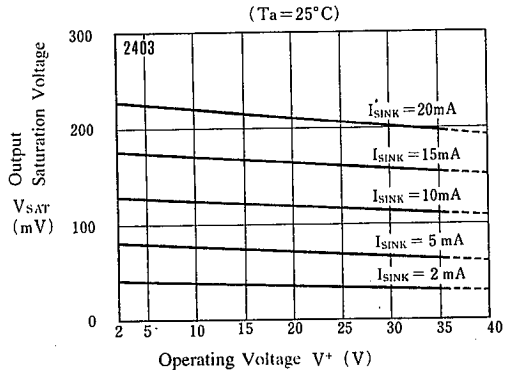

■ TYPICAL APPLICATIONS

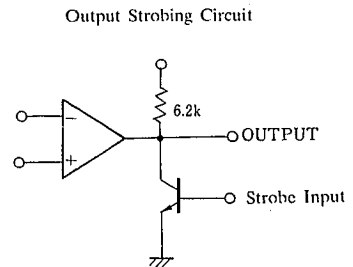
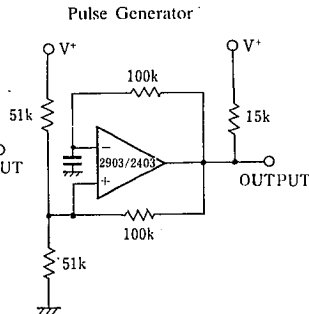
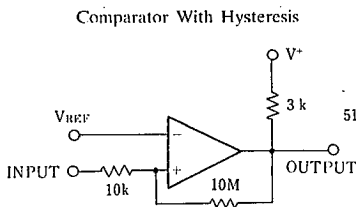

## MEMO

**[CAUTION]**

The specifications on this databook are only given for information, without any guarantee as regards either mistakes or omissions. The application circuits in this databook are described only to show representative usages of the product and not intended for the guarantee or permission of any right including the industrial rights.