

## LOW-VOLTAGE OPERATION DUAL C-MOS OPERATIONAL AMPLIFIER

### ■ GENERAL DESCRIPTION

The NJU7018 is a low voltage single-power-supply and low operating current dual C-MOS operational amplifier.

The input bias current is as low as less than 1pA consequently the very small signal around the ground level can be amplified.

The minimum operating voltage is 1V and the output stage permits output signals to swing between both of the supply rails.

Furthermore, the NJU7018 is packaged with a various small one therefore it can be especially applied to portable items.

### ■ PACKAGE OUTLINE

**NJU7018D**

**NJU7018M**

**NJU7018V**

**NJU7018R**

### ■ FEATURES

- Single-Power-Supply
- Wide Operating Voltage  $V_{DD}=1\sim 5.5V$
- Wide Output Swing Range  $V_{OM}=2.9V \text{ min @} 3.0V$
- Low Operating Current  $I_{DD}=0.75mA \text{ typ./ circuit}$
- Low Bias Current  $I_{IB}=1pA \text{ typ.}$
- Compensation Capacitor Incorporated
- C-MOS Technology
- Package Outline DIP-8/DMP-8/SSOP-8/VSP-8

### ■ PIN CONFIGURATION

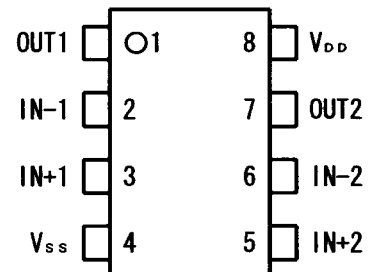

### ■ EQUIVALENT CIRCUIT

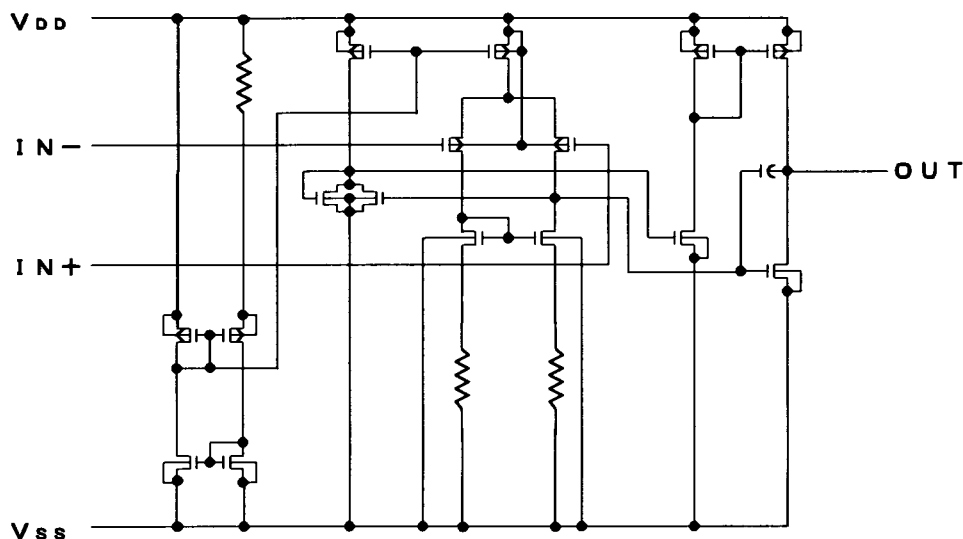

**■ ABSOLUTE MAXIMUM RATINGS**

(Ta=25°C)

PARAMETER	SYMBOL	RATINGS	UNIT
Supply Voltage	$V_{IN}$	7	V
Differential Input Voltage	$V_{ID}$	$\pm 7$ Note1	V
Common Mode Input Voltage	$V_{IC}$	- 0.3 ~ 7	V
Power Dissipation	$P_D$	500 (DIP-8) 300 (DMP-8) 250 (SSOP-8) 320 (VSP-8)	mW
Operating Temperature	$T_{opr}$	- 40 ~ + 85	°C
Storage Temperature	$T_{stg}$	- 55 ~ +125	°C

Note1) If the supply voltage ( $V_{DD}$ ) is less than 7V, the input voltage must not over the  $V_{DD}$  level though 7V is limit specified.

Note2) Decoupling capacitor should be connected between  $V_{DD}$  and  $V_{SS}$  due to the stabilized operation for the circuit.

**■ ELECTRICAL CHARACTERISTICS**

 (Ta=25°C,  $V_{DD}=3.0V$ ,  $R_L=\infty$ )

PARAMETER	SYMBOL	CONDITIONS	MIN	TYP	MAX	UNIT
Input Offset Voltage	$V_{IO}$	$V_{IN}=1/2V_{DD}$	—	—	10	mV
Input Offset Current	$I_{IO}$		—	1	—	pA
Input Bias Current	$I_{IB}$		—	1	—	pA
Input Impedance	$R_{IN}$		—	1	—	TΩ
Large Signal Voltage Gain	$A_{VD}$		60	70	—	dB
Input Common Mode Voltage Range	$V_{ICM}$		0~2.5	—	—	V
Maximum Output Swing Voltage	$V_{OM1}$ $V_{OM2}$	$R_L=16k\Omega$ $R_L=16k\Omega$	$V_{DD}-0.1$ —	— —	— $V_{SS}+0.1$	V V
Common Mode Rejection Ratio	CMR	$V_{IN}=1/2V_{DD}$	55	65	—	dB
Supply Voltage Rejection Ratio	SVR	$V_{DD}=1.5\sim 5.5V$	60	70	—	dB
Operating Current	$I_{DD}$	Per Circuit	—	0.75	1.5	mA
Slew Rate	SR		—	3.7	—	V/ $\mu$ s
Unity Gain Bandwidth	Ft	$A_V=40dB$ , $C_L=10pF$	—	1.0	—	MHz

Note3) The source current is less than 181 $\mu$ A (at  $V_{OM}/R_L=2.9V/16k\Omega$ ).

■ TYPICAL CHARACTERISTICS

Output Voltage vs. Output Current (SOURCE)

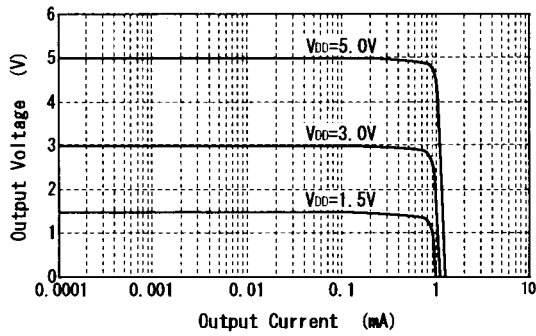

Offset Voltage vs. Operating Voltage

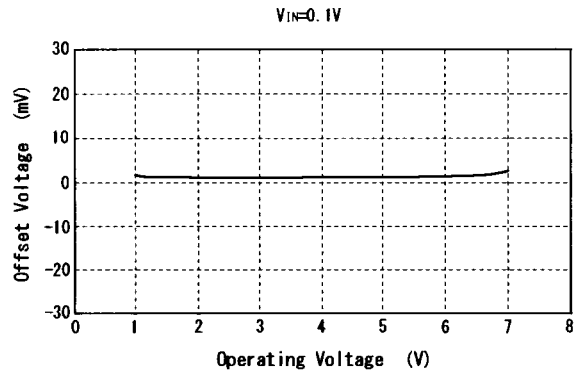

Operating Current vs. Operating Voltage

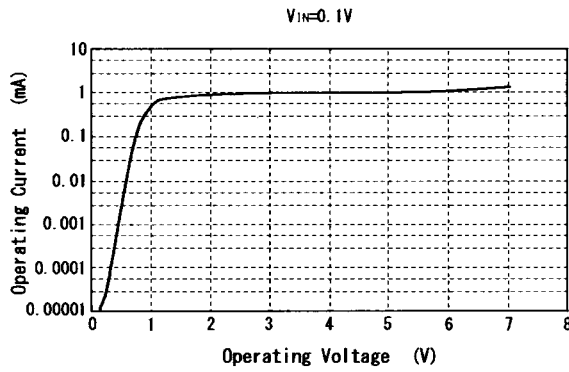

Output Current vs. Operating Voltage

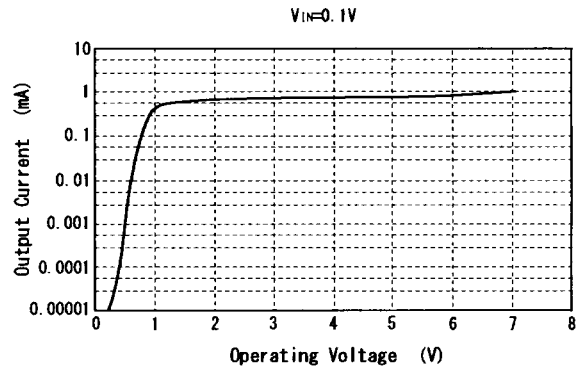

Maximum Output Swing Voltage vs. Load Resistance

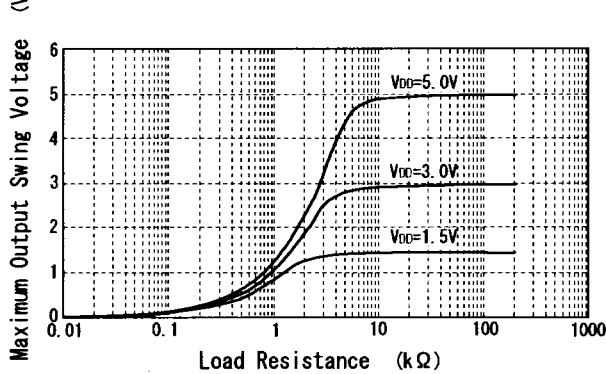

Maximum Output Swing Voltage vs. Frequency

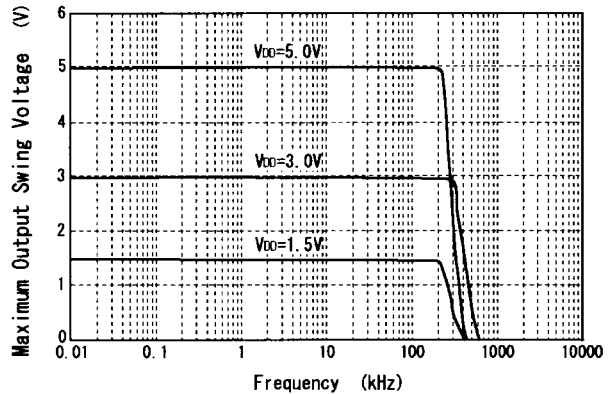

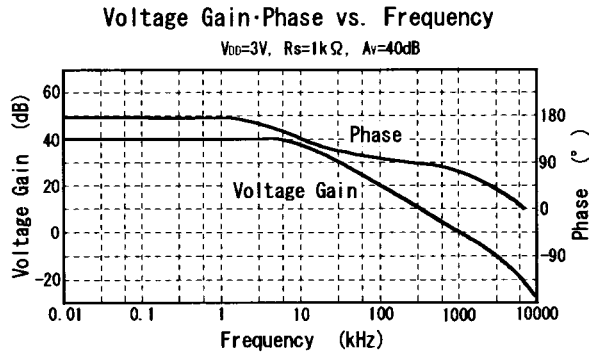

**[CAUTION]**  
 The specifications on this data book are only given for information, without any guarantee as regards either mistakes or omissions. The application circuits in this data book are described only to show representative usages of the product and not intended for the guarantee or permission of any right including the industrial rights.