

## 54ACT323 8-Bit Universal Shift/Storage Register with Synchronous Reset and Common I/O Pins

### General Description

The 'ACT323 is an 8-bit universal shift/storage register with TRI-STATE® outputs. Parallel load inputs and flip-flop outputs are multiplexed to minimize pin count. Separate serial inputs and outputs are provided for  $Q_0$  and  $Q_7$  to allow easy cascading. Four operation modes are possible: hold (store), shift left, shift right and parallel load.

### Features

- $I_{CC}$  and  $I_{OZ}$  reduced by 50%

- Common parallel I/O for reduced pin count
- Additional serial inputs and outputs for expansion
- Four operating modes: shift left, shift right, load and store
- TRI-STATE outputs for bus-oriented applications
- Outputs source/sink 24 mA
- TTL-compatible inputs
- Standard Military Drawing (SMD)  
— 'ACT323: 5962-91607

### Logic Symbols

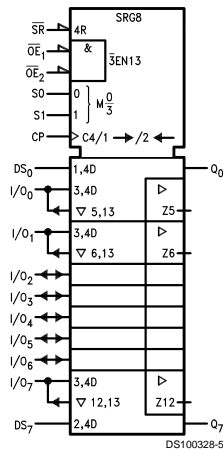
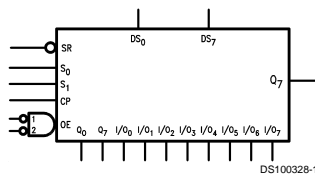

Pin Name	Description
CP	Clock Pulse Input
$DS_0$	Serial Data Input for Right Shift
$DS_7$	Serial Data Input for Left Shift
$S_0, S_1$	Mode Select Inputs
$\overline{SR}$	Synchronous Reset Input
$\overline{OE}_1, \overline{OE}_2$	TRI-STATE Output Enable Inputs
$I/O_0-I/O_7$	Multiplexed Parallel Data Inputs or TRI-STATE Parallel Data Outputs
$Q_0, Q_7$	Serial Outputs

TRI-STATE® is a registered trademark of National Semiconductor Corporation.  
FACT™ is a trademark of Fairchild Semiconductor Corporation.

## Connection Diagrams

Pin Assignment for  
DIP and Flatpak

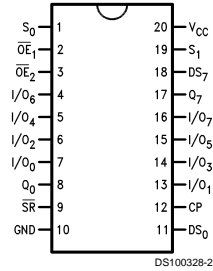

Pin Assignment  
for LCC

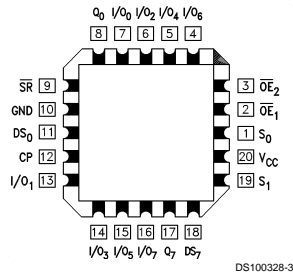

## Functional Description

The 'ACT323 contains eight edge-triggered D-type flip-flops and the interstage logic necessary to perform synchronous reset, shift left, shift right, parallel load and hold operations. The type of operation is determined by  $S_0$  and  $S_1$  as shown in the Mode Select Table. All flip-flop outputs are brought out through TRI-STATE buffers to separate I/O pins that also serve as data inputs in the parallel load mode.  $Q_0$  and  $Q_7$  are also brought out on other pins for expansion in serial shifting of longer words.

A LOW signal on  $\overline{SR}$  overrides the Select inputs and allows the flip-flops to be reset by the next rising edge of CP. All other state changes are also initiated by the LOW-to-HIGH CP transition. Inputs can change when the clock is in either state provided only that the recommended setup and hold times, relative to the rising edge of CP, are observed.

A HIGH signal on either  $\overline{OE}_1$  or  $\overline{OE}_2$  disables the TRI-STATE buffers and puts the I/O pins in the high impedance state. In this condition the shift, load, hold and reset operations can still occur. The TRI-STATE buffers are also disabled by HIGH signals on both  $S_0$  and  $S_1$  in preparation for a parallel load operation.

## Mode Select Table

Inputs				Response
$\overline{SR}$	$S_1$	$S_0$	CP	
L	X	X	↗	Synchronous Reset; $Q_0-Q_7 = \text{LOW}$
H	H	H	↗	Parallel Load; $I/O_n \rightarrow Q_n$
H	L	H	↗	Shift Right; $DS_0 \rightarrow Q_0, Q_0 \rightarrow Q_1, \text{ etc.}$
H	H	L	↗	Shift Left; $DS_7 \rightarrow Q_7, Q_7 \rightarrow Q_6, \text{ etc.}$
H	L	L	X	Hold

H = HIGH Voltage Level  
L = LOW Voltage Level  
X = Immaterial  
↗ = LOW-to-HIGH Clock Transition



## Absolute Maximum Ratings (Note 1)

If Military/Aerospace specified devices are required, please contact the National Semiconductor Sales Office/Distributors for availability and specifications.

Supply Voltage ( $V_{CC}$ )	-0.5V to +7.0V
DC Input Diode Current ( $I_{IK}$ )	
$V_I = -0.5V$	-20 mA
$V_I = V_{CC} + 0.5V$	+20 mA
DC Input Voltage ( $V_I$ )	-0.5V to $V_{CC} + 0.5V$
DC Output Diode Current ( $I_{OK}$ )	
$V_O = -0.5V$	-20 mA
$V_O = V_{CC} + 0.5V$	+20 mA
DC Output Voltage ( $V_O$ )	-0.5V to $V_{CC} + 0.5V$
DC Output Source or Sink Current ( $I_O$ )	±50 mA
DC $V_{CC}$ or Ground Current Per Output Pin ( $I_{CC}$ or $I_{GND}$ )	±50 mA
Storage Temperature ( $T_{STG}$ )	-65°C to +150°C

Junction Temperature ( $T_J$ )

CDIP

175°C

## Recommended Operating Conditions

Supply Voltage ( $V_{CC}$ )	
'ACT	4.5V to 5.5V
Input Voltage ( $V_I$ )	0V to $V_{CC}$
Output Voltage ( $V_O$ )	0V to $V_{CC}$
Operating Temperature ( $T_A$ )	
54ACT	-55°C to +125°C
Minimum Input Edge Rate ( $\Delta V/\Delta t$ )	
'ACT Devices	
$V_{IN}$ from 0.8V to 2.0V	
$V_{CC}$ @ 4.5V, 5.5V	125 mV/ns

**Note 1:** Absolute maximum ratings are those values beyond which damage to the device may occur. The databook specifications should be met, without exception, to ensure that the system design is reliable over its power supply, temperature, and output/input loading variables. National does not recommend operation of FACT™ circuits outside databook specifications.

## DC Electrical Characteristics for 'ACT Family Devices

Symbol	Parameter	$V_{CC}$ (V)	54ACT	Units	Conditions
			$T_A =$ -55°C to +125°C		
			Guaranteed Limits		
$V_{IH}$	Minimum High Level Input Voltage	4.5	2.0	V	$V_{OUT} = 0.1V$ or $V_{CC} - 0.1V$
		5.5	2.0		
$V_{IL}$	Maximum Low Level Input Voltage	4.5	0.8	V	$V_{OUT} = 0.1V$ or $V_{CC} - 0.1V$
		5.5	0.8		
$V_{OH}$	Minimum High Level Output Voltage	4.5	4.4	V	$I_{OUT} = -50 \mu A$
		5.5	5.4		
		4.5	3.70	V	(Note 2) $V_{IN} = V_{IL}$ or $V_{IH}$ $I_{OH} = -24 mA$ $I_{OH} = -24 mA$
		5.5	4.70		
$V_{OL}$	Maximum Low Level Output Voltage	4.5	0.1	V	$I_{OUT} = 50 \mu A$
		5.5	0.1		
		4.5	0.50	V	(Note 2) $V_{IN} = V_{IL}$ or $V_{IH}$ $I_{OL} = -24 mA$ $I_{OL} = -24 mA$
		5.5	0.50		
$I_{IN}$	Maximum Input Leakage Current	5.5	±1.0	μA	$V_I = V_{CC}, GND$
$I_{OZT}$	Maximum I/O Leakage Current	5.5	±5.5	μA	$V_{IO} = V_{CC}$ or GND $V_{IN} = V_{IH}, V_{IL}$
$I_{CCT}$	Maximum $I_{CC}$ /Input	5.5	1.6	mA	$V_I = V_{CC} - 2.1V$
$I_{OLD}$	Minimum Dynamic Output	5.5	50	mA	$V_{OLD} = 1.65V$ Max
$I_{OHD}$	Current (Note 3)	5.5	-50	mA	$V_{OHD} = 3.85V$ Min
$I_{CC}$	Maximum Quiescent Supply Current	5.5	80.0	μA	$V_{IN} = V_{CC}$ or GND

**Note 2:** All outputs loaded; thresholds on input associated with output under test.

**Note 3:** Maximum test duration 2.0 ms, one output loaded at a time.

**Note 4:**  $I_{CC}$  for 54ACT is identical to 74ACT @ 25°C.

## AC Electrical Characteristics

Symbol	Parameter	V <sub>CC</sub> (V) (Note 5)	54ACT		Units
			T <sub>A</sub> = -55°C to +125°C C <sub>L</sub> = 50 pF		
			Min	Max	
f <sub>max</sub>	Maximum Input Frequency	5.0	70		MHz
t <sub>PLH</sub>	Propagation Delay CP to Q <sub>0</sub> or Q <sub>7</sub>	5.0	1.0	16.5	ns
t <sub>PHL</sub>	Propagation Delay CP to Q <sub>0</sub> or Q <sub>7</sub>	5.0	1.0	17.0	ns
t <sub>PLH</sub>	Propagation Delay CP to I/O <sub>n</sub>	5.0	1.0	16.5	ns
t <sub>PHL</sub>	Propagation Delay CP to I/O <sub>n</sub>	5.0	1.0	18.0	ns
t <sub>PZH</sub>	Output Enable Time	5.0	1.0	15.5	ns
t <sub>PZL</sub>	Output Enable Time	5.0	1.0	15.5	ns
t <sub>PHZ</sub>	Output Disable Time	5.0	1.0	15.5	ns
t <sub>PLZ</sub>	Output Disable Time	5.0	1.0	15.0	ns

Note 5: Voltage Range 5.0 is 5.0V ±0.5V

## AC Operating Requirements

Symbol	Parameter	V <sub>CC</sub> (V) (Note 6)	54ACT		Units
			T <sub>A</sub> = -55°C to +125°C C <sub>L</sub> = 50 pF V <sub>CC</sub> = +5.0V		
			Guaranteed Minimum		
t <sub>s</sub>	Setup Time, HIGH or LOW S <sub>0</sub> or S <sub>1</sub> to CP	5.0	6.0		ns
t <sub>h</sub>	Hold Time, HIGH or LOW S <sub>0</sub> or S <sub>1</sub> to CP	5.0	2.0		ns
t <sub>s</sub>	Setup Time, HIGH or LOW I/O <sub>n</sub> , DS <sub>0</sub> , DS <sub>7</sub> to CP	5.0	4.5		ns
t <sub>h</sub>	Hold Time, HIGH or LOW I/O <sub>n</sub> , DS <sub>0</sub> , DS <sub>7</sub> to CP	5.0	2.0		ns
t <sub>s</sub>	Setup Time, HIGH or LOW SR to CP	5.0	3.0		ns
t <sub>h</sub>	Hold Time, HIGH or LOW SR to CP	5.0	1.5		ns
t <sub>w</sub>	CP Pulse Width HIGH or LOW	5.0	5.0		ns

Note 6: Voltage Range 5.0 is 5.0V ±0.5V

## Capacitance

Symbol	Parameter	Typ	Units	Conditions
C <sub>IN</sub>	Input Capacitance	4.5	pF	V <sub>CC</sub> = OPEN
C <sub>PD</sub>	Power Dissipation Capacitance	170	pF	V <sub>CC</sub> = 5.0V

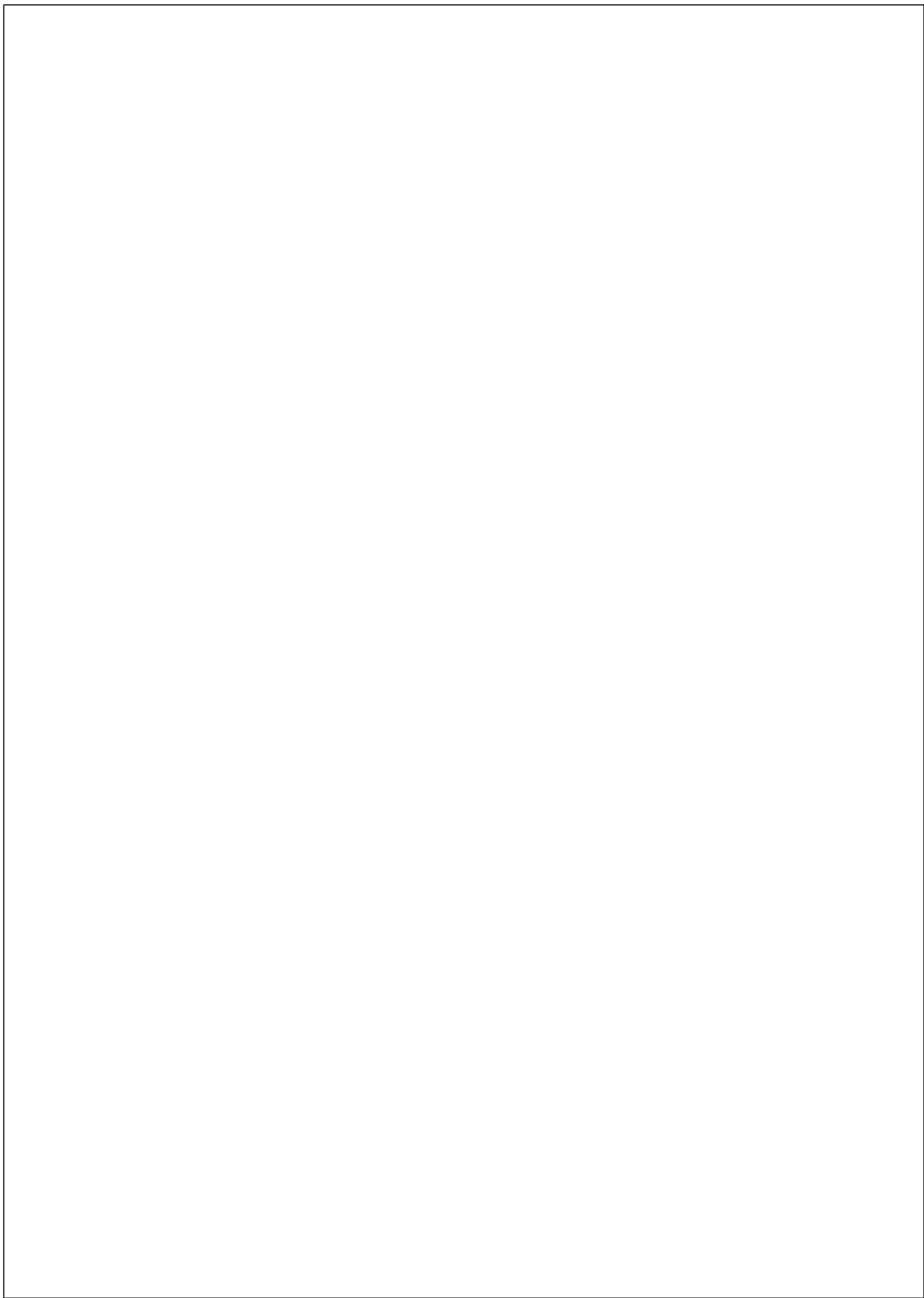

**Physical Dimensions** inches (millimeters) unless otherwise noted

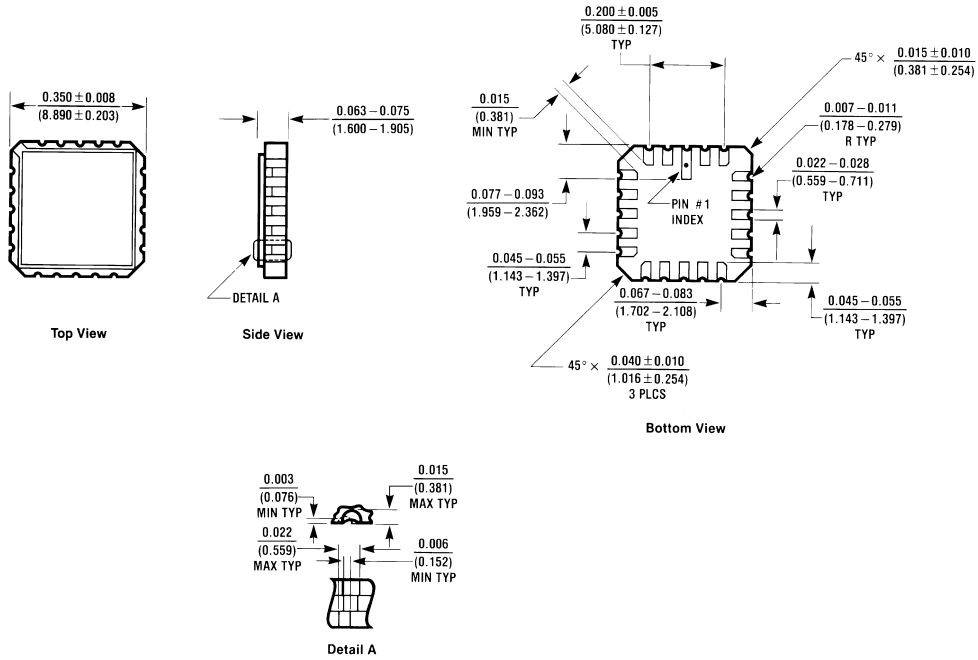

E20A (REV D)

**20 Terminal Ceramic Leadless Chip Carrier (L)**  
**NS Package Number E20A**

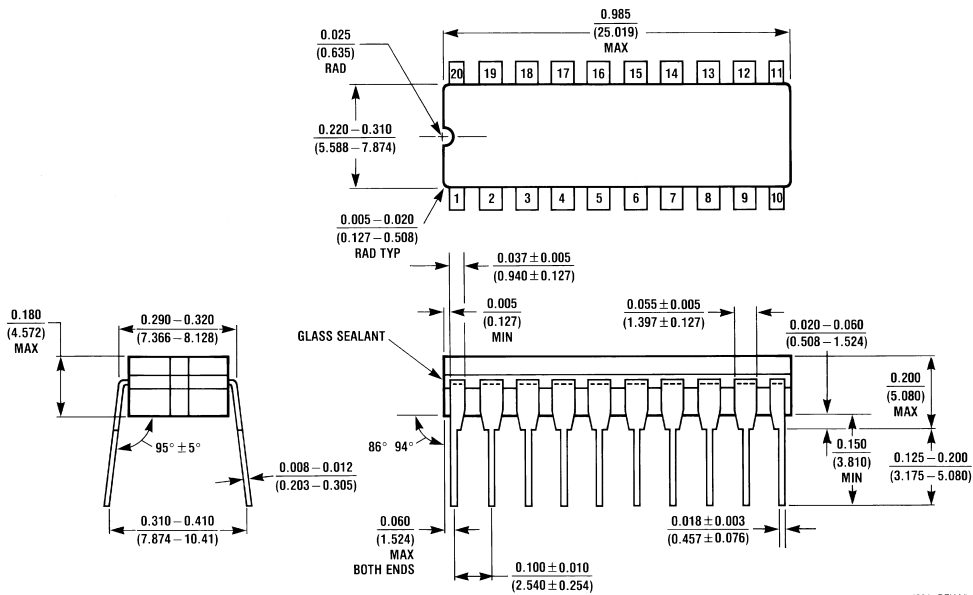

J20A (REV M)

**20 Lead Ceramic Dual-In-Line Package (D)**  
**NS Package Number J20A**

**Physical Dimensions** inches (millimeters) unless otherwise noted (Continued)

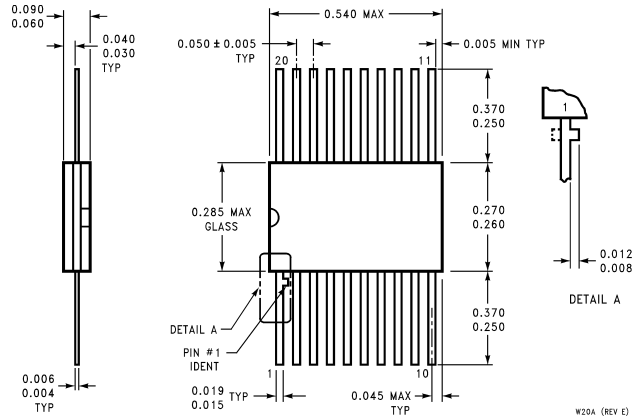

**20 Lead Ceramic Flatpak (F)  
NS Package Number W20A**

**LIFE SUPPORT POLICY**

NATIONAL'S PRODUCTS ARE NOT AUTHORIZED FOR USE AS CRITICAL COMPONENTS IN LIFE SUPPORT DEVICES OR SYSTEMS WITHOUT THE EXPRESS WRITTEN APPROVAL OF THE PRESIDENT OF NATIONAL SEMICONDUCTOR CORPORATION. As used herein:

1. Life support devices or systems are devices or systems which, (a) are intended for surgical implant into the body, or (b) support or sustain life, and whose failure to perform when properly used in accordance with instructions for use provided in the labeling, can be reasonably expected to result in a significant injury to the user.
2. A critical component in any component of a life support device or system whose failure to perform can be reasonably expected to cause the failure of the life support device or system, or to affect its safety or effectiveness.



**National Semiconductor Corporation**  
Americas  
Tel: 1-800-272-9959  
Fax: 1-800-737-7018  
Email: support@nsc.com

**National Semiconductor Europe**  
Fax: +49 (0) 1 80-530 85 86  
Email: europe.support@nsc.com  
Deutsch Tel: +49 (0) 1 80-530 85 85  
English Tel: +49 (0) 1 80-532 78 32  
Français Tel: +49 (0) 1 80-532 93 58  
Italiano Tel: +49 (0) 1 80-534 16 80

**National Semiconductor Asia Pacific Customer Response Group**  
Tel: 65-2544466  
Fax: 65-2504466  
Email: sea.support@nsc.com

**National Semiconductor Japan Ltd.**  
Tel: 81-3-5620-6175  
Fax: 81-3-5620-6179

www.national.com