

54ACT564 Octal D-Type Flip-Flop with TRI-STATE® Outputs

General Description

The 'ACT564 is a high-speed, low power octal flip-flop with a buffered common Clock (CP) and a buffered common Output Enable (\overline{OE}). The information presented to the D inputs is stored in the flip-flops on the LOW-to-HIGH Clock (CP) transition.

The 'ACT564 is functionally identical to the 'ACT574, but with inverted outputs.

Features

- I_{CC} and I_{OZ} reduced by 50%
- Inputs and outputs on opposite sides of package allowing easy interface with microprocessors
- Useful as input or output port for microprocessors
- Functionally identical to 'ACT574 but with inverted outputs
- TRI-STATE outputs for bus-oriented applications
- Outputs source/sink 24 mA
- 'ACT564 has TTL-compatible inputs
- Standard Microcircuit Drawing (SMD) 5962-89557

Logic Symbols

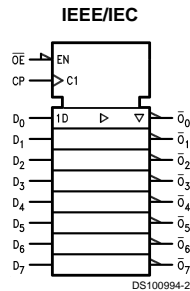
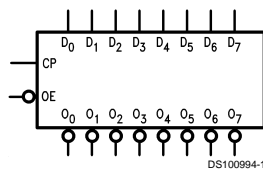

Pin Names	Description
D ₀ -D ₇	Data Inputs
CP	Clock Pulse Input
\overline{OE}	TRI-STATE Output Enable Input
\overline{O}_0 - \overline{O}_7	TRI-STATE Outputs

TRI-STATE® is a registered trademark of National Semiconductor Corporation.
FACT™ is a trademark of Fairchild Semiconductor Corporation.

Connection Diagrams

Pin Assignment for DIP, and Flatpak

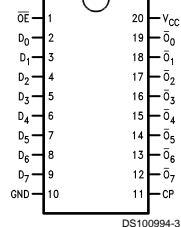

DS100994-3

Pin Assignment for LCC

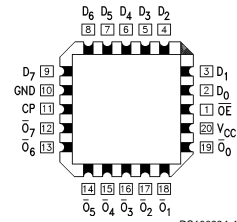

DS100994-4

Functional Description

The ACT564 consists of eight edge-triggered flip-flops with individual D-type inputs and TRI-STATE complement outputs. The buffered clock and buffered Output Enable are common to all flip-flops. The eight flip-flops will store the state of their individual D inputs that meet the setup and hold time requirements on the LOW-to-HIGH Clock (CP) transition. With the Output Enable (\overline{OE}) LOW, the complement of the contents of the eight flip-flops are available at the outputs. When \overline{OE} is HIGH, the outputs go to the high impedance state. Operation of the \overline{OE} input does not affect the state of the flip-flops.

Function Table

Inputs			Internal	Outputs	Function
\overline{OE}	CP	D	Q	O_N	
H	H	L	NC	Z	Hold
H	H	H	NC	Z	Hold
H	N	L	L	Z	Load
H	N	H	H	Z	Load
L	N	L	L	H	Data Available
L	N	H	H	L	Data Available
L	H	L	NC	NC	No Change in Data
L	H	H	NC	NC	No Change in Data

H = HIGH Voltage Level
 L = LOW Voltage Level
 X = Immaterial
 Z = High Impedance
 N = LOW-to-HIGH Transition
 NC = No Change

Absolute Maximum Ratings (Note 1)

If Military/Aerospace specified devices are required, please contact the National Semiconductor Sales Office/Distributors for availability and specifications.

Supply Voltage (V_{CC})	-0.5V to +7.0V
DC Input Diode Current (I_{IK})	
$V_I = -0.5V$	-20 mA
$V_I = V_{CC} + 0.5V$	+20 mA
DC Input Voltage (V_I)	-0.5V to $V_{CC} + 0.5V$
DC Output Diode Current (I_{OK})	
$V_O = -0.5V$	-20 mA
$V_O = V_{CC} + 0.5V$	+20 mA
DC Output Voltage (V_O)	-0.5V to $V_{CC} + 0.5V$
DC Output Source or Sink Current (I_O)	± 50 mA
DC V_{CC} or Ground Current Per Output Pin (I_{CC} or I_{GND})	± 50 mA
Storage Temperature (T_{STG})	-65°C to +150°C
Junction Temperature (T_J)	

CDIP

175°C

Recommended Operating Conditions

Supply Voltage (V_{CC}) (Unless Otherwise Specified) (ACT)	4.5V to 5.5V
Input Voltage (V_I)	0V to V_{CC}
Output Voltage (V_O)	0V to V_{CC}
Operating Temperature (T_A) (ACT)	-55°C to +125°C
Minimum Input Edge Rate ($\Delta V/\Delta t$) 'ACT Devices	
V_{IN} from 0.8V to 2.0V	
V_{CC} @ 4.5V, 5.5V	125 mV/ns

Note 1: Absolute maximum ratings are those values beyond which damage to the device may occur. The databook specifications should be met, without exception, to ensure that the system design is reliable over its power supply, temperature, and output/input loading variables. National does not recommend operation of FACT™ circuits outside databook specifications.

DC Characteristics for 'ACT Family Devices

Symbol	Parameter	V_{CC} (V)	54ACT		Units	Conditions
			$T_A =$ -55°C to +125°C			
			Guaranteed Limits			
V_{IH}	Minimum High Level Input Voltage	4.5	2.0	V	$V_{OUT} = 0.1V$ or $V_{CC} - 0.1V$	
		5.5	2.0			
V_{IL}	Maximum Low Level Input Voltage	4.5	0.8	V	$V_{OUT} = 0.1V$ or $V_{CC} - 0.1V$	
		5.5	0.8			
V_{OH}	Minimum High Level	4.5	4.4	V	$I_{OUT} = -50 \mu A$	
		5.5	5.4			
		4.5	3.70	V	(Note 2) $V_{IN} = V_{IL}$ or V_{IH} $I_{OH} = -24$ mA	
		5.5	4.70			
V_{OL}	Maximum Low Level Output Voltage	4.5	0.1	V	$I_{OUT} = 50 \mu A$	
		5.5	0.1			
		4.5	0.50	V	(Note 2) $V_{IN} = V_{IL}$ or V_{IH} $I_{OL} = 24$ mA	
		5.5	0.50			
I_{IN}	Maximum Input Leakage Current	5.5	± 1.0	μA	$V_I = V_{CC}, GND$	
I_{OZ}	Maximum TRI-STATE Leakage Current	5.5	± 10.0	μA	$V_I = V_{IL}, V_{IH}$ $V_O = V_{CC}, GND$	
I_{CCT}	Maximum I_{CC} /Input	5.5	1.6	mA	$V_I = V_{CC} - 2.1V$	
I_{OLD}	(Note 3) Minimum Dynamic Output Current	5.5	50	mA	$V_{OLD} = 1.65V$	
I_{OHD}		5.5	-50	mA	$V_{OHD} = 3.85V$	
I_{CC}	Maximum Quiescent Supply Current	5.5	80.0	μA	$V_{IN} = V_{CC}$ or GND	

Note 2: All outputs loaded; thresholds on input associated with output under test.

DC Characteristics for 'ACT Family Devices (Continued)

Note 3: Maximum test duration 2.0 ms, one output loaded at a time.

AC Electrical Characteristics for 'ACT Family Devices

Symbol	Parameter	V _{CC} (V) (Note 4)	54ACT		Units
			T _A = -55°C to +125°C C _L = 50 pF		
			Min	Max	
f _{MAX}	Maximum Clock Frequency	5.0	65		ns
t _{PLH}	Propagation Delay CP to O _n	5.0	1.0	12.5	ns
t _{PHL}	Propagation Delay CP to O _n	5.0	1.0	11.5	ns
t _{PZH}	Output Enable Time	5.0	1.0	10.5	ns
t _{PZL}	Output Enable Time	5.0	1.0	10.5	ns
t _{PHZ}	Output Disable Time	5.0	1.0	12.5	ns
t _{PLZ}	Output Disable Time	5.0	1.0	9.5	ns

Note 4: Voltage Range 5.0 is 5.0V ±0.5V

AC Operating Requirements for 'ACT Family Devices

Symbol	Parameter	V _{CC} (V) (Note 5)	54ACT		Units
			T _A = -55°C to +125°C C _L = 50 pF		
			Guaranteed Minimum		
t _s	Set-Up Time, HIGH or LOW D _n to CP	5.0	3.5		ns
t _h	Hold Time, HIGH or LOW D _n to CP	5.0	2.5		ns
t _w	CP Pulse Width HIGH or LOW	5.0	5.0		ns

Note 5: Voltage Range 5.0 is 5.0V ±0.5V

Capacitance

Symbol	Parameter	Typ	Units	Conditions
C _{IN}	Input Capacitance	4.5	pF	V _{CC} = OPEN
C _{PD}	Power Dissipation Capacitance	40.0	pF	V _{CC} = 5.0V

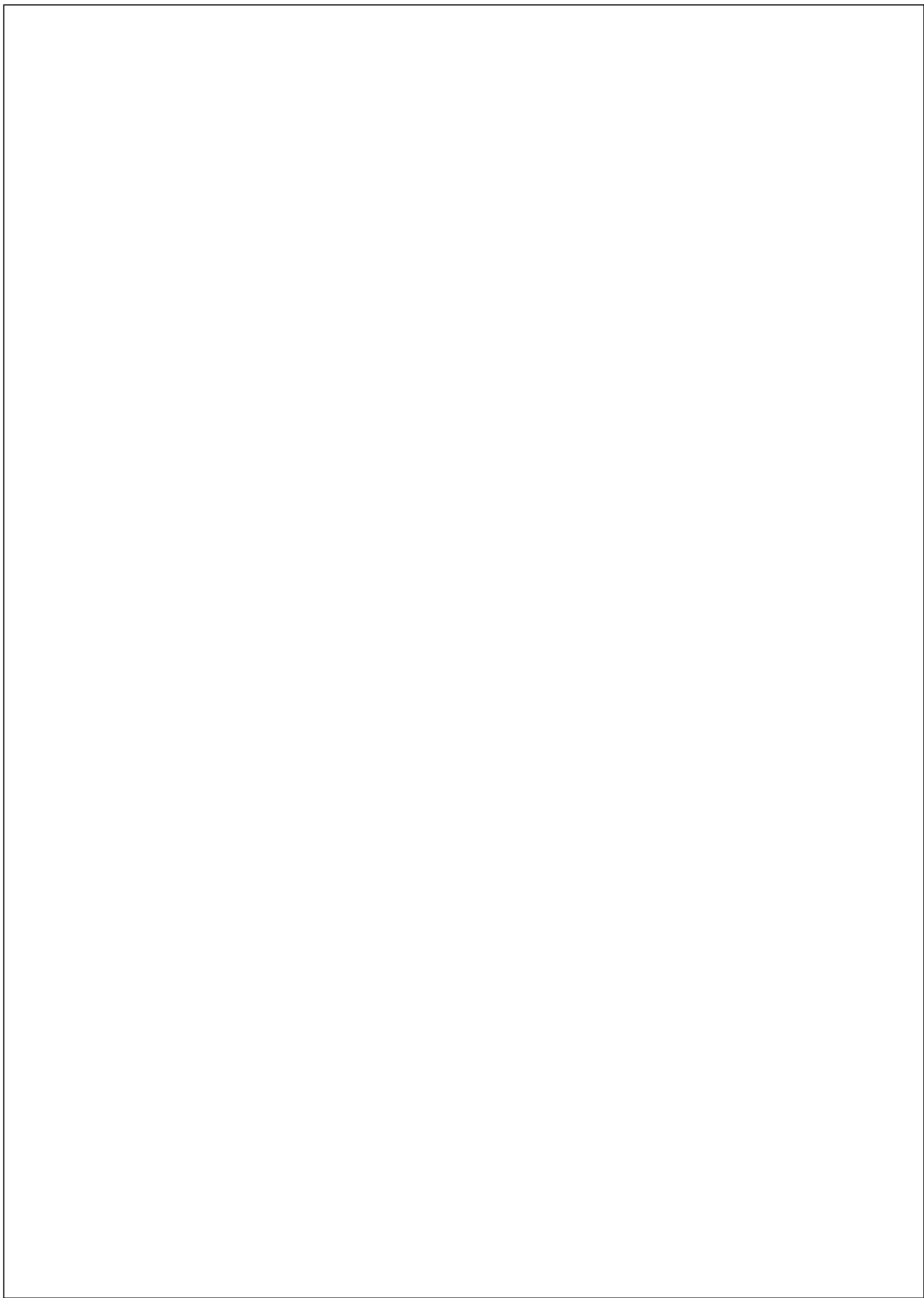

Physical Dimensions inches (millimeters) unless otherwise noted

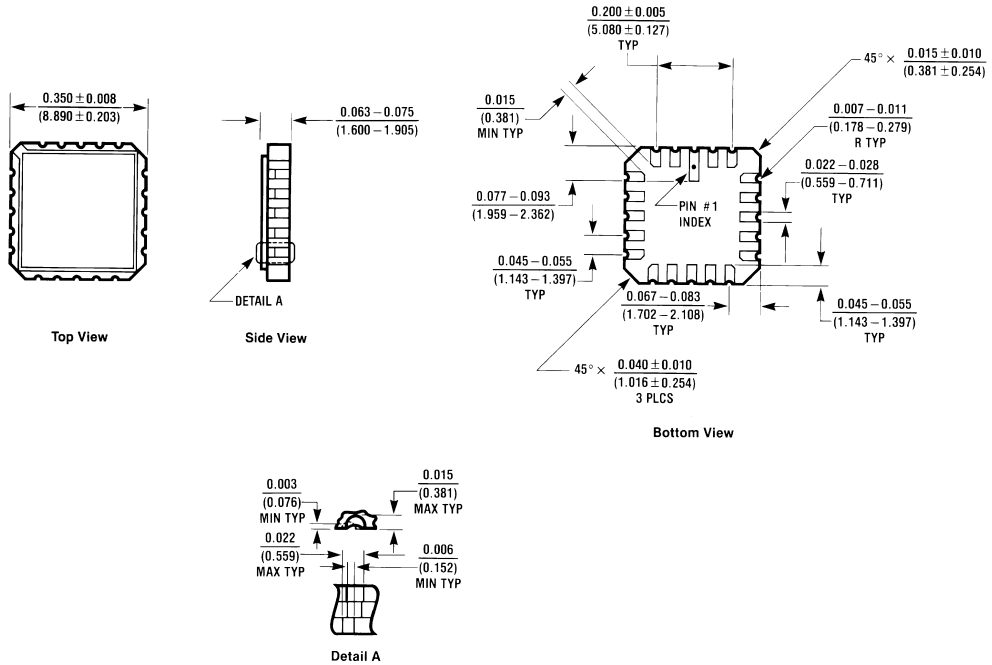

20 Terminal Ceramic Leadless Chip Carrier (L)
NS Package Number E20A

E20A (REV D)

Physical Dimensions inches (millimeters) unless otherwise noted (Continued)

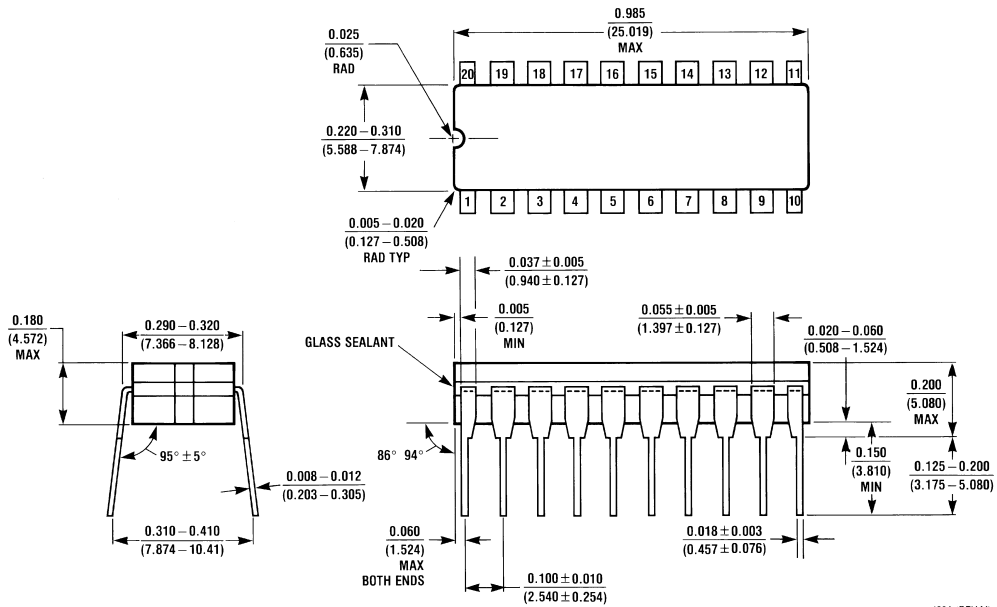

20 Lead Ceramic Dual-In-Line Package (D)
NS Package Number J20A

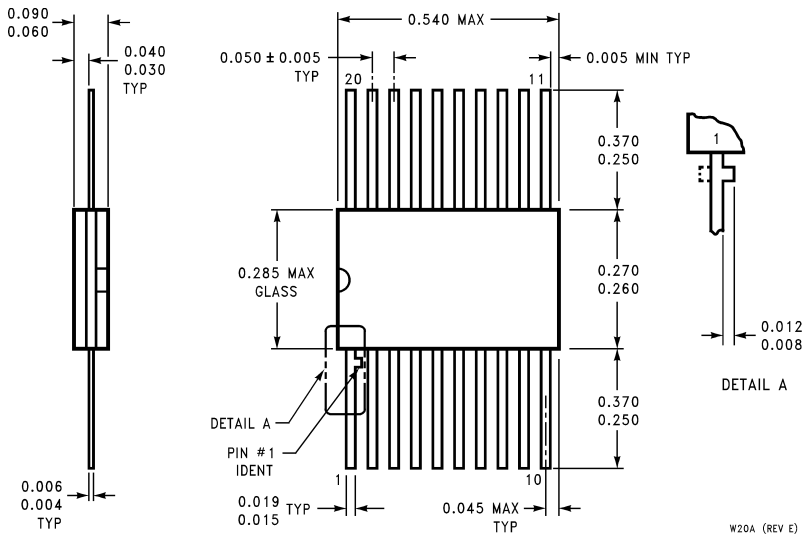

20 Lead Ceramic Flatpak (F)
NS Package Number W20A

LIFE SUPPORT POLICY

NATIONAL'S PRODUCTS ARE NOT AUTHORIZED FOR USE AS CRITICAL COMPONENTS IN LIFE SUPPORT DEVICES OR SYSTEMS WITHOUT THE EXPRESS WRITTEN APPROVAL OF THE PRESIDENT OF NATIONAL SEMICONDUCTOR CORPORATION. As used herein:

1. Life support devices or systems are devices or systems which, (a) are intended for surgical implant into the body, or (b) support or sustain life, and whose failure to perform when properly used in accordance with instructions for use provided in the labeling, can be reasonably expected to result in a significant injury to the user.
2. A critical component in any component of a life support device or system whose failure to perform can be reasonably expected to cause the failure of the life support device or system, or to affect its safety or effectiveness.



National Semiconductor Corporation
Americas
Tel: 1-800-272-9959
Fax: 1-800-737-7018
Email: support@nsc.com

www.national.com

National Semiconductor Europe
Fax: +49 (0) 1 80-530 85 86
Email: europe.support@nsc.com
Deutsch Tel: +49 (0) 1 80-530 85 85
English Tel: +49 (0) 1 80-532 78 32
Français Tel: +49 (0) 1 80-532 93 58
Italiano Tel: +49 (0) 1 80-534 16 80

National Semiconductor Asia Pacific Customer Response Group
Tel: 65-2544466
Fax: 65-2504466
Email: sea.support@nsc.com

National Semiconductor Japan Ltd.
Tel: 81-3-5620-6175
Fax: 81-3-5620-6179