

## 54F/74F676 16-Bit Serial/Parallel-In, Serial-Out Shift Register

### General Description

The 'F676 contains 16 flip-flops with provision for synchronous parallel or serial entry and serial output. When the Mode (M) input is HIGH, information present on the parallel data (P<sub>0</sub>–P<sub>15</sub>) inputs is entered on the falling edge of the Clock Pulse (CP) input signal. When M is LOW, data is shifted out of the most significant bit position while information present on the Serial (SI) input shifts into the least significant bit position. A HIGH signal on the Chip Select (CS) input prevents both parallel and serial operations.

### Features

- 16-bit parallel-to-serial conversion
- 16-bit serial-in, serial-out
- Chip select control
- Slim 24 lead 300 mil package

Commercial	Military	Package Number	Package Description
74F676PC		N24A	24-Lead (0.600" Wide) Molded Dual-In-Line
74F676SPC		N24C	24-Lead (0.300" Wide) Molded Dual-In-Line
	54F676DM (Note 2)	J24A	24-Lead (0.600" Wide) Ceramic Dual-In-Line
	54F676SDM (Note 2)	J24F	24-Lead (0.300" Wide) Ceramic Dual-In-Line
74F676SC (Note 1)		M24B	24-Lead (0.300" Wide) Molded Small Outline, JEDEC
	54F676FM (Note 2)	W24C	24-Lead Cerpack
	54F676LM (Note 2)	E28A	24-Lead Ceramic Leadless Chip Carrier, Type C

**Note 1:** Devices also available in 13" reel. Use suffix = SCX.

**Note 2:** Military grade device with environmental and burn-in processing. Use suffix = DMQB, FMQB and LMQB.

### Connection Diagrams

Pin Assignment  
for DIP, SOIC and Flatpak

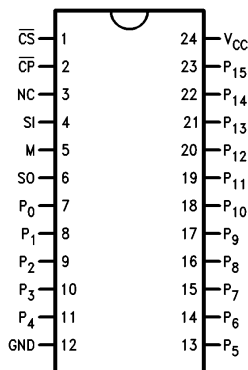

TL/F/9588-2

Pin Assignment  
for LCC

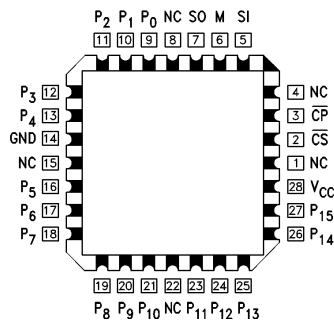

TL/F/9588-3

TRI-STATE® is a registered trademark of National Semiconductor Corporation.

## Logic Symbols

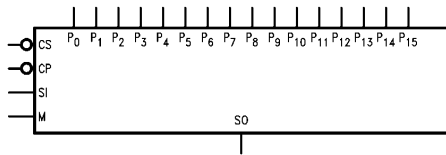

TL/F/9588-1

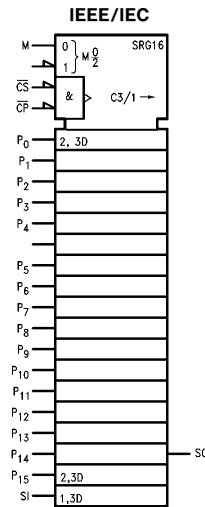

TL/F/9588-4

## Unit Loading/Fan Out

Pin Names	Description	54F/74F	
		U.L. HIGH/LOW	Input I <sub>IH</sub> /I <sub>IL</sub> Output I <sub>OH</sub> /I <sub>OL</sub>
P <sub>0</sub> -P <sub>15</sub>	Parallel Data Inputs	1.0/1.0	20 μA/ -0.6 mA
$\overline{CS}$	Chip Select Input (Active LOW)	1.0/1.0	20 μA/ -0.6 mA
$\overline{CP}$	Clock Pulse Input (Active LOW)	1.0/1.0	20 μA/ -0.6 mA
M	Mode Select Input	1.0/1.0	20 μA/ -0.6 mA
SI	Serial Data Input	1.0/1.0	20 μA/ -0.6 mA
SO	Serial Output	50/33.3	-1 mA/20 mA

## Functional Description

The 16-bit shift register operates in one of three modes, as indicated in the Shift Register Operations Table.

**HOLD**—a HIGH signal on the Chip Select ( $\overline{CS}$ ) input prevents clocking, and data is stored in the sixteen registers.

**Shift/Serial Load**—data present on the SI pin shifts into the register on the falling edge of  $\overline{CP}$ . Data enters the Q<sub>0</sub> position and shifts toward Q<sub>15</sub> on successive clocks, finally appearing on the SO pin.

**Parallel Load**—data present on P<sub>0</sub>-P<sub>15</sub> are entered into the register on the falling edge of  $\overline{CP}$ . The SO output represents the Q<sub>15</sub> register output.

To prevent false clocking,  $\overline{CP}$  must be LOW during a LOW-to-HIGH transition of  $\overline{CS}$ .

Shift Register Operations Table

Control Input			Operating Mode
$\overline{CS}$	M	$\overline{CP}$	
H	X	X	Hold
L	L	~	Shift/Serial Load
L	H	~	Parallel Load

H = HIGH Voltage Level  
L = LOW Voltage Level  
X = Immaterial  
~ = HIGH-to-LOW Transition

## Block Diagram

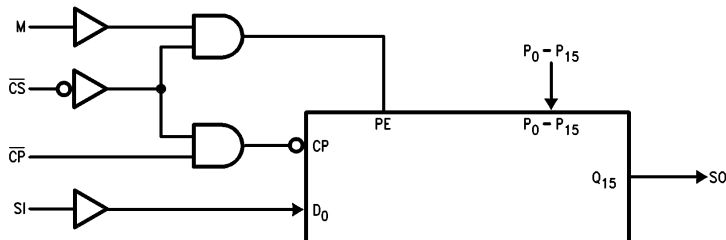

TL/F/9588-5

## Absolute Maximum Ratings (Note 1)

If Military/Aerospace specified devices are required, please contact the National Semiconductor Sales Office/Distributors for availability and specifications.

Storage Temperature	-65°C to +150°C
Ambient Temperature under Bias	-55°C to +125°C
Junction Temperature under Bias	-55°C to +175°C
Plastic	-55°C to +150°C
V <sub>CC</sub> Pin Potential to Ground Pin	-0.5V to +7.0V
Input Voltage (Note 2)	-0.5V to +7.0V
Input Current (Note 2)	-30 mA to +5.0 mA
Voltage Applied to Output in HIGH State (with V <sub>CC</sub> = 0V)	
Standard Output	-0.5V to V <sub>CC</sub>
TRI-STATE® Output	-0.5V to +5.5V
Current Applied to Output in LOW State (Max)	twice the rated I <sub>OL</sub> (mA)

**Note 1:** Absolute maximum ratings are values beyond which the device may be damaged or have its useful life impaired. Functional operation under these conditions is not implied.

**Note 2:** Either voltage limit or current limit is sufficient to protect inputs.

## Recommended Operating Conditions

Free Air Ambient Temperature	
Military	-55°C to +125°C
Commercial	0°C to +70°C
Supply Voltage	
Military	+4.5V to +5.5V
Commercial	+4.5V to +5.5V

## DC Electrical Characteristics

Symbol	Parameter	54F/74F			Units	V <sub>CC</sub>	Conditions
		Min	Typ	Max			
V <sub>IH</sub>	Input HIGH Voltage	2.0			V		Recognized as a HIGH Signal
V <sub>IL</sub>	Input LOW Voltage			0.8	V		Recognized as a LOW Signal
V <sub>CD</sub>	Input Clamp Diode Voltage			-1.2	V	Min	I <sub>IN</sub> = -18 mA
V <sub>OH</sub>	Output HIGH Voltage	54F 10% V <sub>CC</sub> 74F 10% V <sub>CC</sub> 74F 5% V <sub>CC</sub>	2.5 2.5 2.7		V	Min	I <sub>OH</sub> = -1 mA I <sub>OH</sub> = -1 mA I <sub>OH</sub> = -1 mA
V <sub>OL</sub>	Output LOW Voltage	54F 10% V <sub>CC</sub> 74F 10% V <sub>CC</sub>		0.5 0.5	V	Min	I <sub>OL</sub> = 20 mA I <sub>OL</sub> = 20 mA
I <sub>IH</sub>	Input HIGH Current	54F 74F		20.0 5.0	μA	Max	V <sub>IN</sub> = 2.7V
I <sub>BVI</sub>	Input HIGH Current Breakdown Test	54F 74F		100 7.0	μA	Max	V <sub>IN</sub> = 7.0V
I <sub>CEX</sub>	Output HIGH Leakage Current	54F 74F		250 50	μA	Max	V <sub>OUT</sub> = V <sub>CC</sub>
V <sub>ID</sub>	Input Leakage Test	74F	4.75		V	0.0	I <sub>ID</sub> = 1.9 μA, All Other Pins Grounded
I <sub>OD</sub>	Output Leakage Circuit Current	74F		3.75	μA	0.0	V <sub>ID</sub> = 150 mV, All Other Pins Grounded
I <sub>IL</sub>	Input LOW Current			-0.6	mA	Max	V <sub>IN</sub> = 0.5V
I <sub>OS</sub>	Output Short-Circuit Current			-60	mA	Max	V <sub>OUT</sub> = 0V
I <sub>CC</sub>	Power Supply Current			72	mA	Max	

## AC Electrical Characteristics

Symbol	Parameter	74F			54F		74F		Units
		T <sub>A</sub> = +25°C V <sub>CC</sub> = +5.0V C <sub>L</sub> = 50 pF			T <sub>A</sub> , V <sub>CC</sub> = Mil C <sub>L</sub> = 50 pF		T <sub>A</sub> , V <sub>CC</sub> = Com C <sub>L</sub> = 50 pF		
		Min	Typ	Max	Min	Max	Min	Max	
f <sub>max</sub>	Maximum Clock Frequency	100	110		45		90	MHz	
t <sub>PLH</sub> t <sub>PHL</sub>	Propagation Delay $\overline{CP}$ to SO	4.5	9.0	11.0	4.5	17.0	4.5	12.0	ns
		5.0	9.0	12.5	5.0	14.5	5.0	13.5	

## AC Operating Requirements

Symbol	Parameter	74F		54F		74F		Units
		T <sub>A</sub> = +25°C V <sub>CC</sub> = +5.0V		T <sub>A</sub> , V <sub>CC</sub> = Mil		T <sub>A</sub> , V <sub>CC</sub> = Com		
		Min	Max	Min	Max	Min	Max	
t <sub>s</sub> (H) t <sub>s</sub> (L)	Setup Time, HIGH or LOW SI to $\overline{CP}$	4.0		4.0		4.0		ns
t <sub>h</sub> (H) t <sub>h</sub> (L)	Hold Time, HIGH or LOW SI to $\overline{CP}$	4.0		4.0		4.0		
t <sub>s</sub> (H) t <sub>s</sub> (L)	Setup Time, HIGH or LOW P <sub>n</sub> to $\overline{CP}$	3.0		3.0		3.0		ns
t <sub>h</sub> (H) t <sub>h</sub> (L)	Hold Time, HIGH or LOW P <sub>n</sub> to $\overline{CP}$	4.0		4.0		4.0		
t <sub>s</sub> (H) t <sub>s</sub> (L)	Setup Time, HIGH or LOW M to $\overline{CP}$	8.0		8.0		8.0		ns
t <sub>h</sub> (H) t <sub>h</sub> (L)	Hold Time, HIGH or LOW M to $\overline{CP}$	2.0		2.0		2.0		
t <sub>s</sub> (L)	Setup Time, LOW $\overline{CS}$ to $\overline{CP}$	10.0		12.0		10.0		ns
t <sub>h</sub> (H)	Hold Time, HIGH $\overline{CS}$ to $\overline{CP}$	10.0		10.0		10.0		
t <sub>w</sub> (H) t <sub>w</sub> (L)	$\overline{CP}$ Pulse Width HIGH or LOW	4.0		5.0		4.0		ns
		6.0		9.0		6.0		

## Ordering Information

The device number is used to form part of a simplified purchasing code where the package type and temperature range are defined as follows:

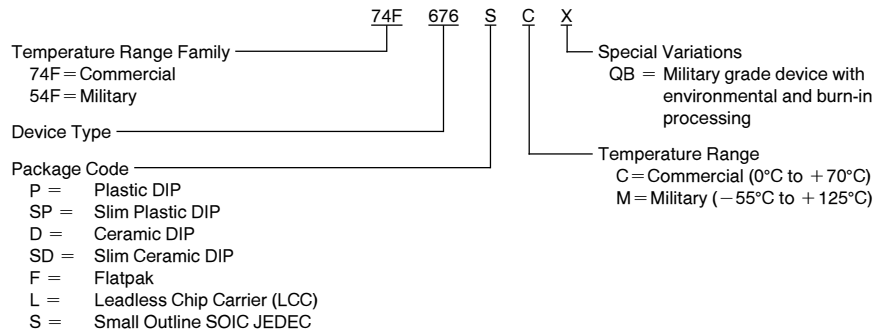

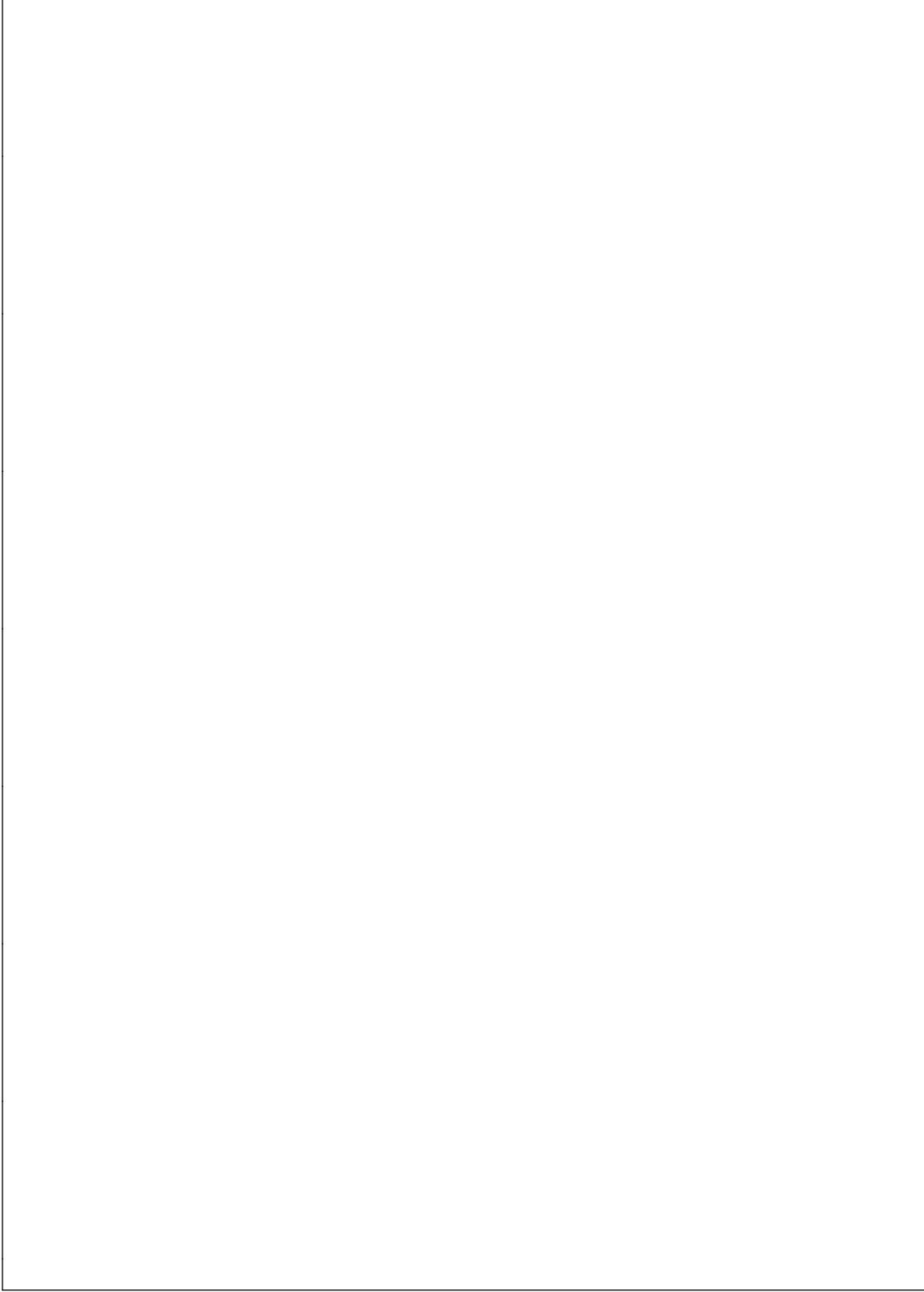

**Physical Dimensions** inches (millimeters)

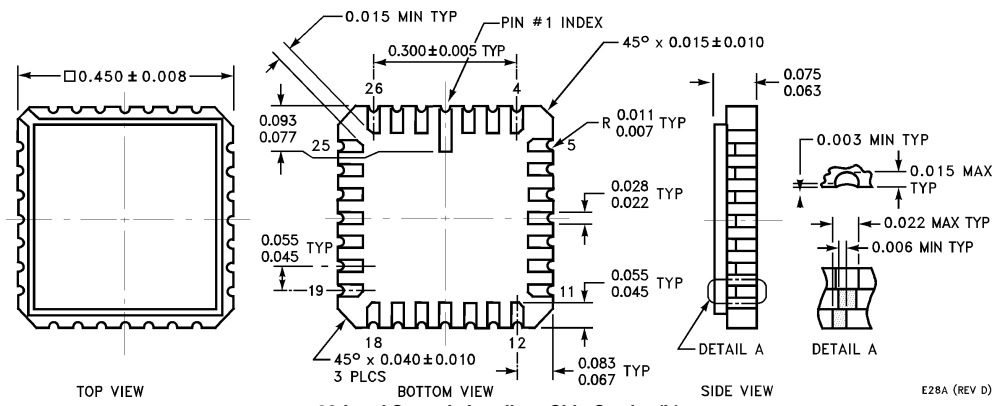

**28-Lead Ceramic Leadless Chip Carrier (L)**  
**NS Package Number E28A**

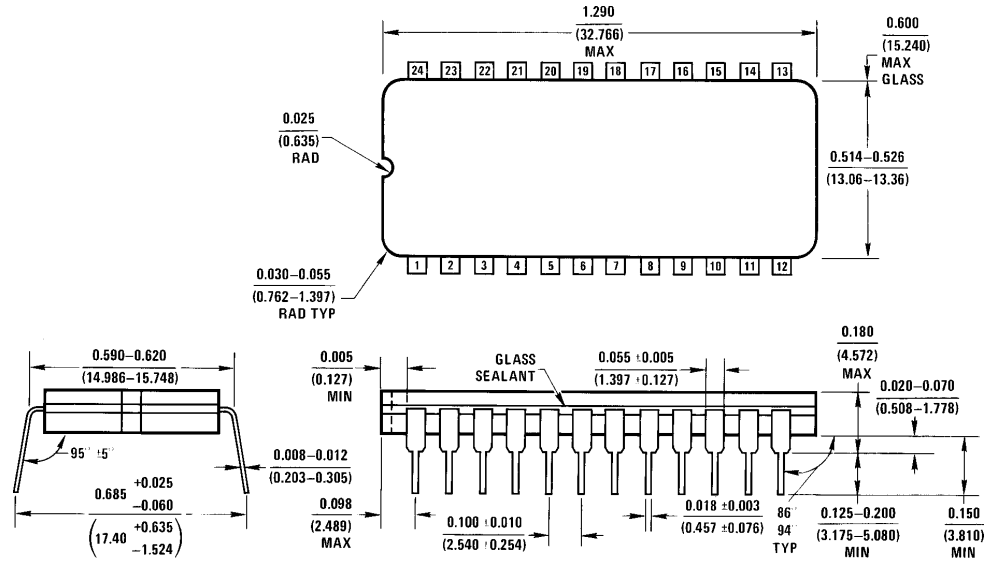

**24-Lead Ceramic Dual-In-Line Package (D)**  
**NS Package Number J24A**

J24A (REV H)

**Physical Dimensions** inches (millimeters) (Continued)

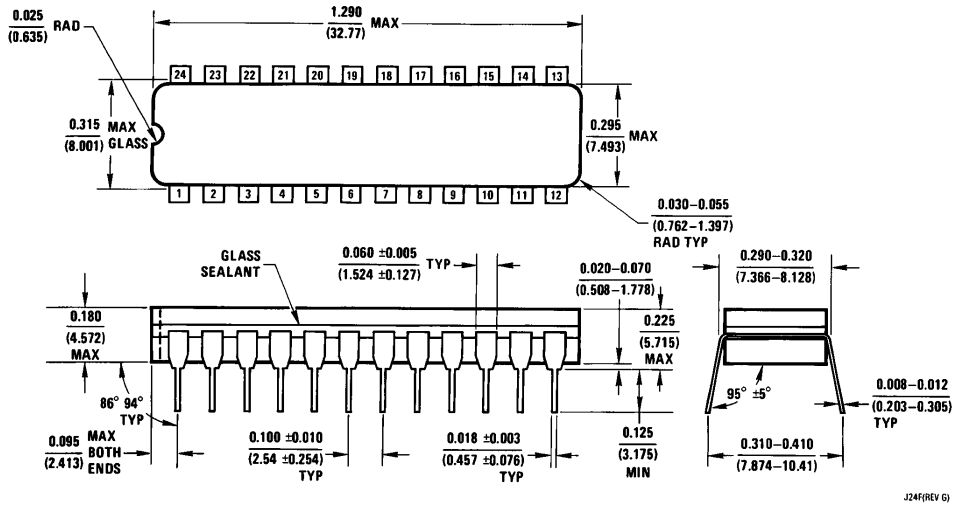

**24-Lead (0.300" Wide) Ceramic Dual-In-Line Package (SD)**  
 NS Package Number J24F

J24F (REV G)

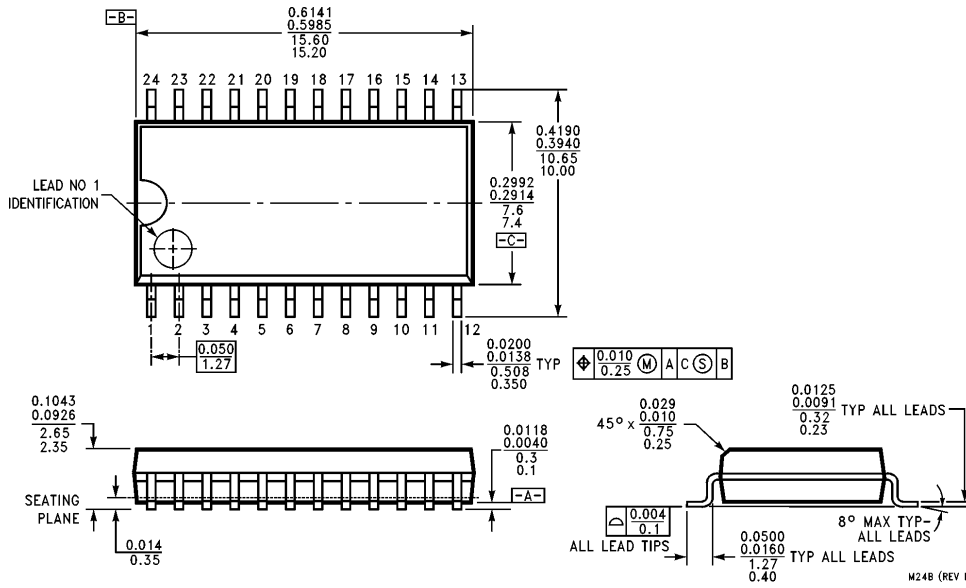

**24-Lead (0.300" Wide) Molded Small Outline Package, JEDEC**  
 NS Package Number M24B

M24B (REV F)



**Physical Dimensions** inches (millimeters) (Continued)

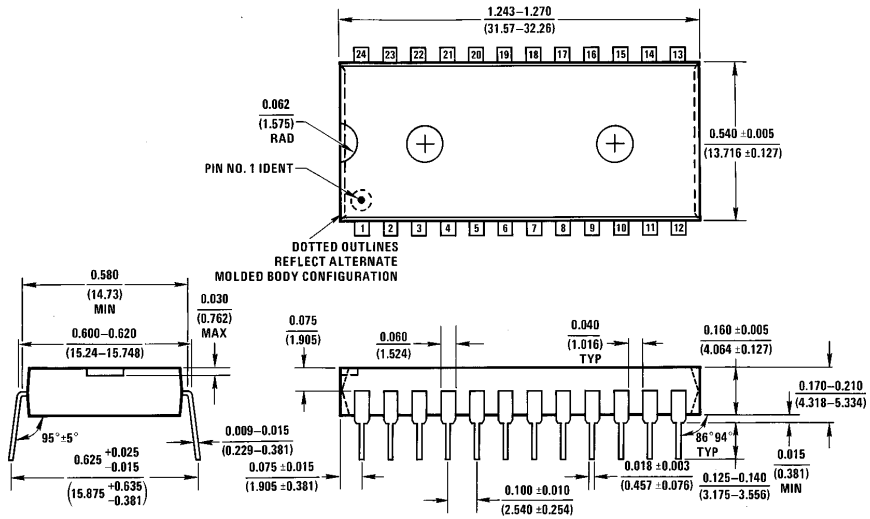

**24-Lead (0.600" Wide) Molded Dual-In-Line Package (P)**  
NS Package Number N24A

N24A (REV E)

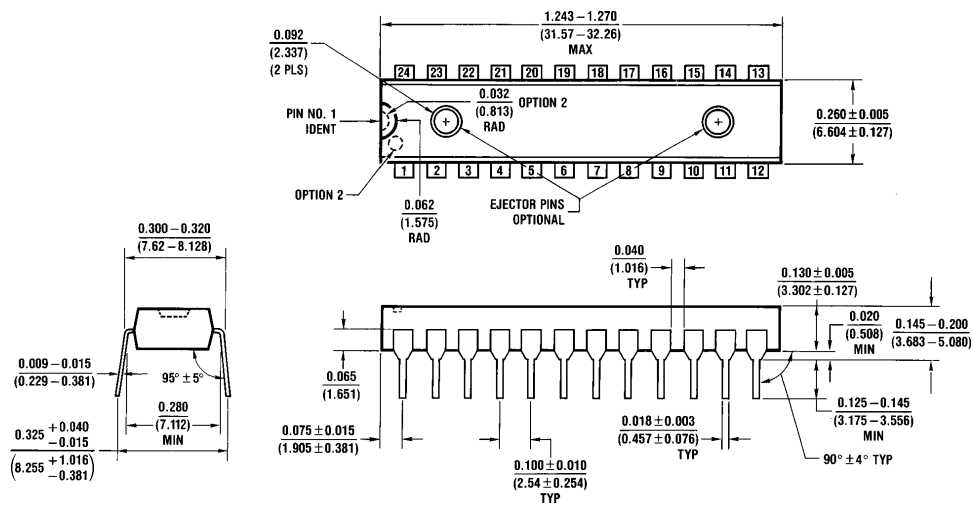

**24-Lead (0.300" Wide) Molded Dual-In-Line Package (SP)**  
NS Package Number N24C

N24C (REV F)

**Physical Dimensions** inches (millimeters) (Continued)

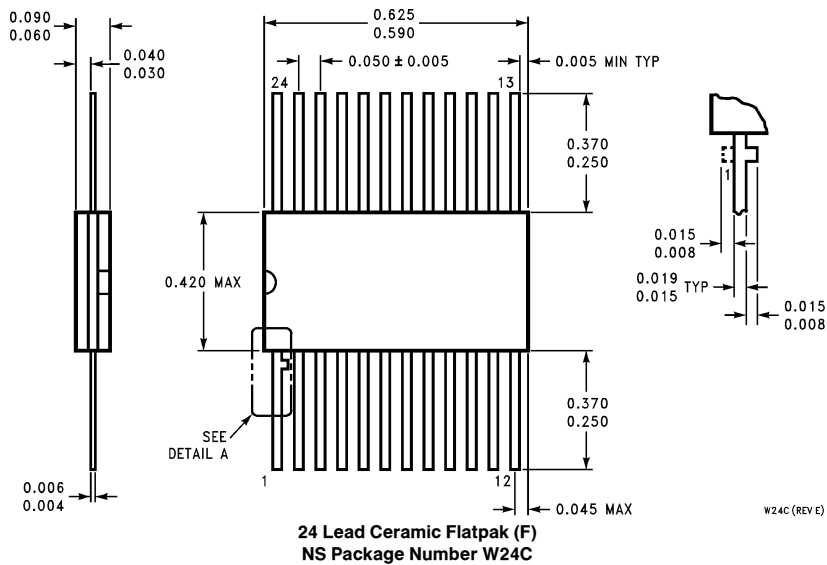

W24C (REV E)

**LIFE SUPPORT POLICY**

NATIONAL'S PRODUCTS ARE NOT AUTHORIZED FOR USE AS CRITICAL COMPONENTS IN LIFE SUPPORT DEVICES OR SYSTEMS WITHOUT THE EXPRESS WRITTEN APPROVAL OF THE PRESIDENT OF NATIONAL SEMICONDUCTOR CORPORATION. As used herein:

1. Life support devices or systems are devices or systems which, (a) are intended for surgical implant into the body, or (b) support or sustain life, and whose failure to perform, when properly used in accordance with instructions for use provided in the labeling, can be reasonably expected to result in a significant injury to the user.
2. A critical component is any component of a life support device or system whose failure to perform can be reasonably expected to cause the failure of the life support device or system, or to affect its safety or effectiveness.



**National Semiconductor Corporation**  
 1111 West Bardin Road  
 Arlington, TX 76017  
 Tel: 1(800) 272-9959  
 Fax: 1(800) 737-7018

**National Semiconductor Europe**  
 Fax: (+49) 0-180-530 85 86  
 Email: cnjwge@tevm2.nsc.com  
 Deutsch Tel: (+49) 0-180-530 85 85  
 English Tel: (+49) 0-180-532 78 32  
 Français Tel: (+49) 0-180-532 93 58  
 Italiano Tel: (+49) 0-180-534 16 80

**National Semiconductor Hong Kong Ltd.**  
 13th Floor, Straight Block,  
 Ocean Centre, 5 Canton Rd.  
 Tsimshatsui, Kowloon  
 Hong Kong  
 Tel: (852) 2737-1600  
 Fax: (852) 2736-9960

**National Semiconductor Japan Ltd.**  
 Tel: 81-043-299-2309  
 Fax: 81-043-299-2408

National does not assume any responsibility for use of any circuitry described, no circuit patent licenses are implied and National reserves the right at any time without notice to change said circuitry and specifications.