

54F/74F827 • 74F828 10-Bit Buffers/Line Drivers

General Description

The 'F827 and 'F828 10-bit bus buffers provide high performance bus interface buffering for wide data/address paths or buses carrying parity. The 10-bit buffers have NOR output enables for maximum control flexibility.

The 'F827 and 'F828 are functionally- and pin-compatible to AMD's Am29827 and Am29828. The 'F828 is an inverting version of the 'F827.

Features

- TRI-STATE® output
- 'F828 is inverting
- Direct replacement for AMD's Am29827 and Am29828

Commercial	Military	Package Number	Package Description
74F827SPC		N24C	24-Lead (0.300" Wide) Molded Dual-In-Line
	54F827SDM (Note 2)	J24F	24-Lead (0.300" Wide) Ceramic Dual-In-Line
74F827SC (Note 1)		M24B	24-Lead (0.300" Wide) Molded Small Outline, JEDEC
	54F827FM (Note 2)	W24C	24-Lead Cerpack
	54F827LM (Note 2)	E28A	24-Lead Ceramic Leadless Chip Carrier, Type C
74F828SPC		N24C	24-Lead (0.300" Wide) Molded Dual-In-Line
74F828SC (Note 1)		M24B	24-Lead (0.300" Wide) Molded Small Outline, JEDEC

Note 1: Devices also available in 13" reel. Use suffix = SCX.

Note 2: Military grade device with environmental and burn-in processing. Use suffix = SDM, FMQB and LMQB.

Connection Diagrams

Pin Assignment for
DIP, Flatpak and SOIC

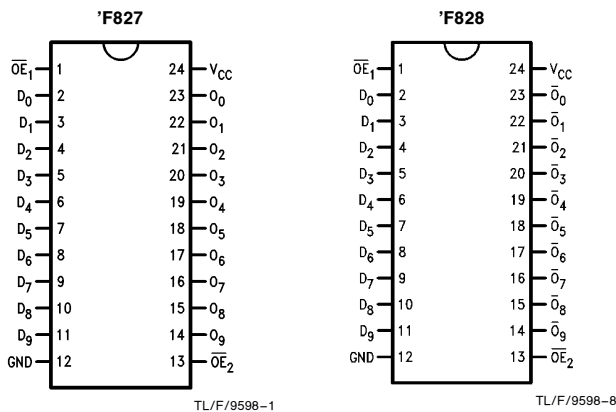

Pin Assignment
for LCC

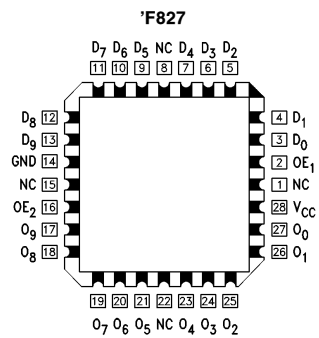

TRI-STATE® is a registered trademark of National Semiconductor Corporation.

Logic Symbols

IEEE/IEC
'F827

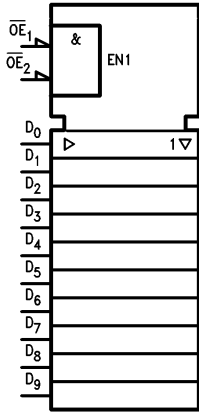

TL/F/9598-6

IEEE/IEC
'F828

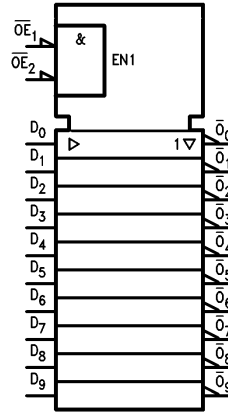

TL/F/9598-7

'F827

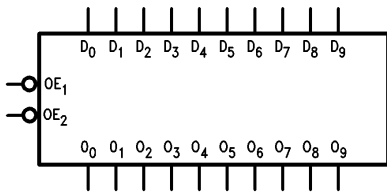

TL/F/9598-3

'F828

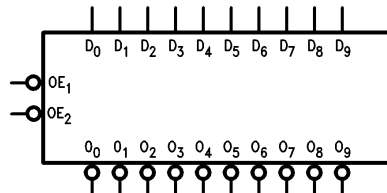

TL/F/9598-10

Unit Loading/Fan Out

Pin Names	Description	54F/74F	
		U.L. HIGH/LOW	Input I_{IH}/I_{IL} Output I_{OH}/I_{OL}
$\overline{OE}_1, \overline{OE}_2$	Output Enable Input	1.0/1.0	20 μA / -0.6 mA
D_0-D_7	Data Inputs	1.0/1.0	20 μA / -0.6 mA
O_0-O_7	Data Outputs, TRI-STATE	600/106.6 (80)	-12 mA/64 mA (48 mA)

Functional Description

The 'F827 and 'F828 are line drivers designed to be employed as memory address drivers, clock drivers and bus-oriented transmitters/receivers which provide improved PC board density. The devices have TRI-STATE outputs controlled by the Output Enable (\overline{OE}) pins. The outputs can sink 64 mA (48 mA mil) and source 15 mA. Input clamp diodes limit high-speed termination effects.

Function Table

Inputs		Outputs		Function
\overline{OE}	D_n	O_n		
		'F827	'F828	
L	H	H	L	Transparent
L	L	L	H	Transparent
H	X	Z	Z	High Z

H = HIGH Voltage level
L = LOW Voltage Level
Z = High Impedance
X = Immaterial

Logic Diagrams

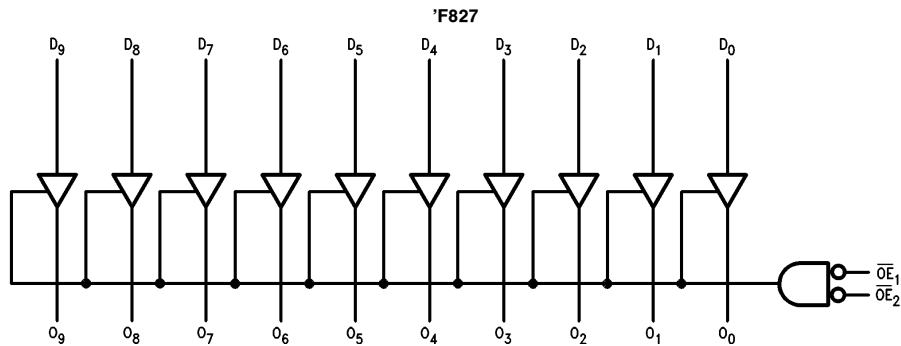

TL/F/9598-4

Please note that this diagram is provided only for the understanding of logic operations and should not be used to estimate propagation delays.

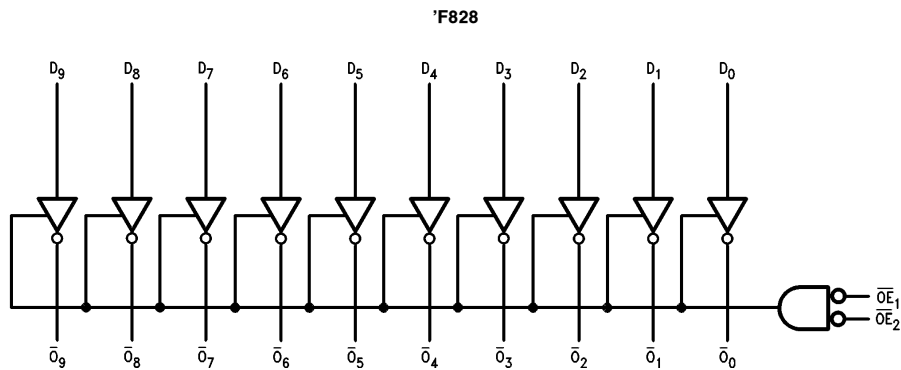

TL/F/9598-11

Please note that this diagram is provided only for the understanding of logic operations and should not be used to estimate propagation delays.

Absolute Maximum Ratings (Note 1)

If Military/Aerospace specified devices are required, please contact the National Semiconductor Sales Office/Distributors for availability and specifications.

Storage Temperature	–65°C to +150°C
Ambient Temperature under Bias	–55°C to +125°C
Junction Temperature under Bias	–55°C to +175°C
Plastic	–55°C to +150°C
V _{CC} Pin Potential to Ground Pin	–0.5V to +7.0V
Input Voltage (Note 2)	–0.5V to +7.0V
Input Current (Note 2)	–30 mA to +5.0 mA
Voltage Applied to Output in HIGH State (with V _{CC} = 0V)	
Standard Output	–0.5V to V _{CC}
TRI-STATE Output	–0.5V to +5.5V

Current Applied to Output in LOW State (Max) twice the rated I_{OL} (mA)

Note 1: Absolute maximum ratings are values beyond which the device may be damaged or have its useful life impaired. Functional operation under these conditions is not implied.

Note 2: Either voltage limit or current limit is sufficient to protect inputs.

Recommended Operating Conditions

Free Air Ambient Temperature	
Military	–55°C to +125°C
Commercial	0°C to +70°C
Supply Voltage	
Military	+4.5V to +5.5V
Commercial	+4.5V to +5.5V

DC Electrical Characteristics

Symbol	Parameter	54F/74F			Units	V _{CC}	Conditions
		Min	Typ	Max			
V _{IH}	Input HIGH Voltage	2.0			V		Recognized as a HIGH Signal
V _{IL}	Input LOW Voltage						Recognized as a LOW Signal
V _{CD}	Input Clamp Diode Voltage					Min	I _{IN} = –18 mA
V _{OH}	Output HIGH Voltage	54F 10% V _{CC}	2.4		V	Min	I _{OH} = –3 mA
		54F 10% V _{CC}	2.0				I _{OH} = –12 mA
		74F 10% V _{CC}	2.4				I _{OH} = –3 mA
		74F 10% V _{CC}	2.0				I _{OH} = –15 mA
		74F 5% V _{CC}	2.7				I _{OH} = –3 mA
V _{OL}	Output LOW Voltage	54F 10% V _{CC}		0.55	V	Min	I _{OL} = 48 mA
		74F 10% V _{CC}		0.55			I _{OL} = 64 mA
I _{IH}	Input HIGH Current	54F		20.0	μA	Max	V _{IN} = 2.7V
		74F		5.0			
I _{BVI}	Input HIGH Current Breakdown Test	54F		100	μA	Max	V _{IN} = 7.0V
		74F		7.0			
I _{CEX}	Output HIGH Leakage Current	54F		250	μA	Max	V _{OUT} = V _{CC}
		74F		50			
V _{ID}	Input Leakage Test	74F	4.75		V	0.0	I _{ID} = 1.9 μA All Other Pins Grounded
I _{OD}	Output Leakage Circuit Current	74F		3.75	μA	0.0	V _{IOD} = 150 mV All Other Pins Grounded
I _{IL}	Input LOW Current			–0.6	mA	Max	V _{IN} = 0.5V
I _{OZH}	Output Leakage Current			50	μA	Max	V _{OUT} = 2.7V
I _{OZL}	Output Leakage Current			–50	μA	Max	V _{OUT} = 0.5V
I _{OS}	Output Short-Circuit Current			–100	mA	Max	V _{OUT} = 0V

DC Electrical Characteristics (Continued)

Symbol	Parameter	54F/74F			Units	V _{CC}	Conditions
		Min	Typ	Max			
I _{ZZ}	Bus Drainage Test			500	μA	0.0V	V _{OUT} = 5.25V
I _{CCH}	Power Supply Current ('F827)		30	45	mA	Max	V _O = HIGH
I _{CCL}	Power Supply Current ('F827)		60	90	mA	Max	V _O = LOW
I _{CCZ}	Power Supply Current ('F827)		40	60	mA	Max	V _O = HIGH Z
I _{CCH}	Power Supply Current ('F828)		14	20	mA	Max	V _O = HIGH
I _{CCL}	Power Supply Current ('F828)		56	85	mA	Max	V _O = LOW
I _{CCZ}	Power Supply Current ('F828)		35	50	mA	Max	V _O = HIGH Z

AC Electrical Characteristics

Symbol	Parameter	74F			54F		74F		Units
		T _A = +25°C V _{CC} = +5.0V C _L = 50 pF			T _A , V _{CC} = Mil C _L = 50 pF		T _A , V _{CC} = Com C _L = 50 pF		
		Min	Typ	Max	Min	Max	Min	Max	
t _{PLH}	Propagation Delay	1.0	3.0	5.5	1.0	7.5	1.0	6.5	ns
t _{PHL}	Data to Output ('F827)	1.5	3.3	5.5	1.5	7.0	1.5	6.0	
t _{PLH}	Propagation Delay	1.0	3.0	5.0			1.0	5.5	ns
t _{PHL}	Data to Output ('F828)	1.0	2.0	4.0			1.0	4.0	
t _{PZH}	Output Enable Time	3.0	5.7	9.0	2.5	10.0	2.5	9.5	ns
t _{PZL}	\overline{OE} to O _n	3.5	6.8	11.5	3.0	12.5	3.0	12.0	
t _{PHZ}	Output Disable Time	1.5	3.3	8.0	1.5	9.0	1.5	8.5	ns
t _{PLZ}	\overline{OE} to O _n	1.0	3.5	8.0	1.0	9.0	1.0	8.5	

Ordering Information

The device number is used to form part of a simplified purchasing code where the package type and temperature range are defined as follows:

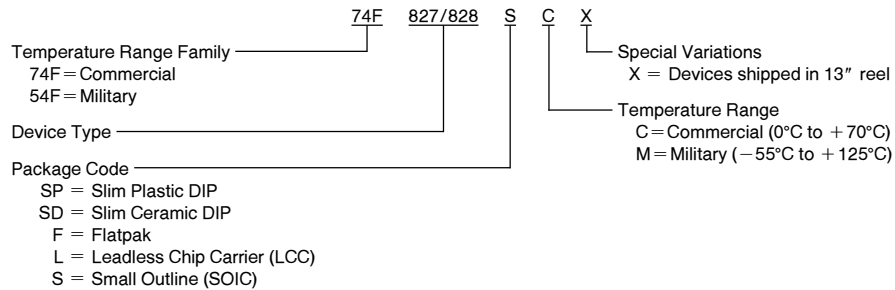

Physical Dimensions inches (millimeters)

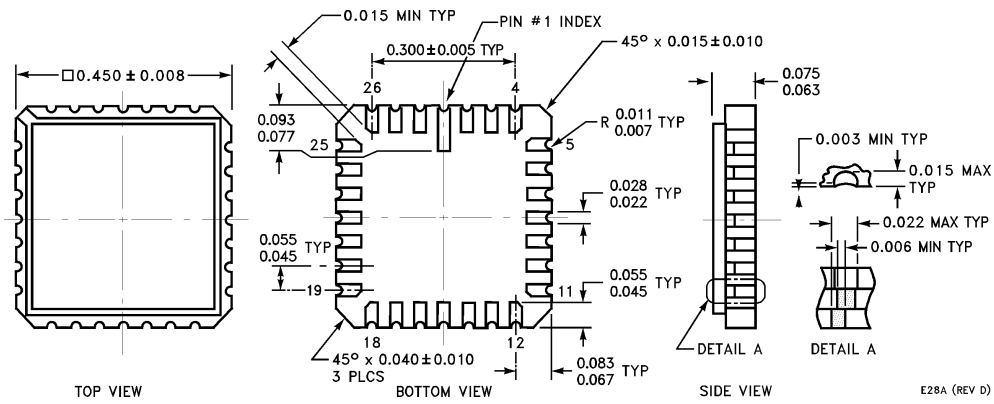

28-Lead Ceramic Leadless Chip Carrier (L)
NS Package Number E28A

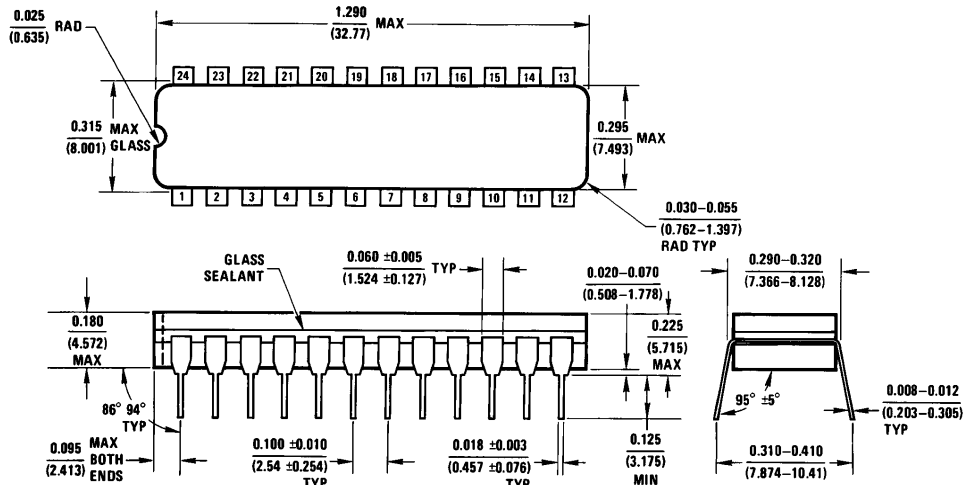

24-Lead (0.300" Wide) Ceramic Dual-In-Line Package (SD)
NS Package Number J24F

Physical Dimensions inches (millimeters) (Continued)

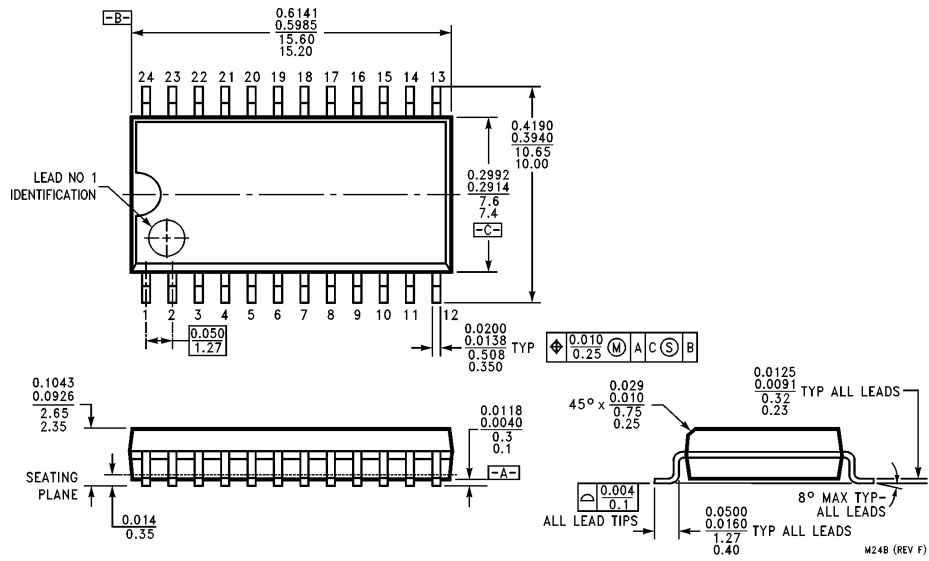

**24-Lead Small Outline Integrated Circuit (S)
NS Package Number M24B**

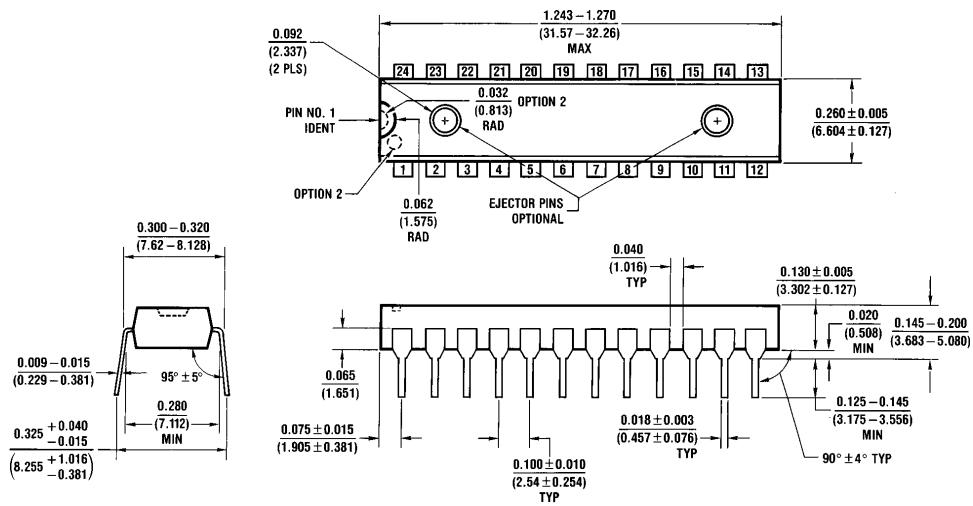

**24-Lead Plastic Slim (0.300" Wide) Dual-In-Line Package (SP)
NS Package Number N24C**

Physical Dimensions inches (millimeters) (Continued)

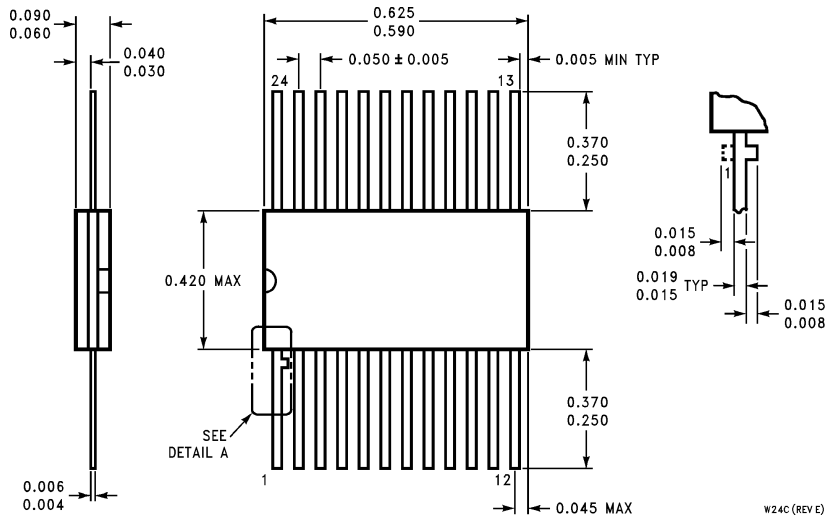

**24-Lead Ceramic Flatpak (F)
NS Package Number W24C**

LIFE SUPPORT POLICY

NATIONAL'S PRODUCTS ARE NOT AUTHORIZED FOR USE AS CRITICAL COMPONENTS IN LIFE SUPPORT DEVICES OR SYSTEMS WITHOUT THE EXPRESS WRITTEN APPROVAL OF THE PRESIDENT OF NATIONAL SEMICONDUCTOR CORPORATION. As used herein:

1. Life support devices or systems are devices or systems which, (a) are intended for surgical implant into the body, or (b) support or sustain life, and whose failure to perform, when properly used in accordance with instructions for use provided in the labeling, can be reasonably expected to result in a significant injury to the user.
2. A critical component is any component of a life support device or system whose failure to perform can be reasonably expected to cause the failure of the life support device or system, or to affect its safety or effectiveness.



National Semiconductor Corporation
2900 Semiconductor Drive
P.O. Box 58090
Santa Clara, CA 95052-8090
Tel: 1(800) 272-9959
TWX: (910) 339-9240

National Semiconductor GmbH
Livry-Gargan-Str. 10
D-82256 Fürstenfeldbruck
Germany
Tel: (61-41) 35-0
Telex: 527649
Fax: (61-41) 35-1

National Semiconductor Japan Ltd.
Sumitomo Chemical Engineering Center
Bldg. 7F
1-7-1, Nakase, Mihama-Ku
Chiba-City,
Chiba Prefecture 261
Tel: (043) 299-2300
Fax: (043) 299-2500

National Semiconductor Hong Kong Ltd.
13th Floor, Straight Block,
Ocean Centre, 5 Canton Rd.
Tsimshatsui, Kowloon
Hong Kong
Tel: (852) 2737-1600
Fax: (852) 2736-9960

National Semiconductores Do Brazil Ltda.
Rue Deputado Lacerda Franco
120-3A
Sao Paulo-SP
Brazil 05418-000
Tel: (55-11) 212-5066
Telex: 391-1131931 NSBR BR
Fax: (55-11) 212-1181

National Semiconductor (Australia) Pty, Ltd.
Building 16
Business Park Drive
Monash Business Park
Nottingham, Melbourne
Victoria 3168 Australia
Tel: (3) 558-9999
Fax: (3) 558-9998

National does not assume any responsibility for use of any circuitry described, no circuit patent licenses are implied and National reserves the right at any time without notice to change said circuitry and specifications.